

CAL·MIL

4079 Calle Platino
Oceanside, CA 92056

www.calmil.com
contactcalmil@calmil.com

© 2016 CAL·MIL Plastic Products, Inc.

(760) 630-5100 Phone
(760) 630-5010 Fax For Ordering
(760) 630-9865 General Fax

(800) 321-9069 Toll Free
(U.S.A. & Canada)

C
A
L
M
I
L

2
0
1
6



CAL·MIL 2016



Madera Collection, Pages 2 - 11



Urban Collection, Pages 12 - 15



Luxe Collection, Pages 48 - 53





























Cal•Mil Collections











Madera Collection	2 - 11
Urban Collection	12 - 15
Bamboo Collection	16 - 29
Eco Modern Collection	30 - 31
Midnight Bamboo Collection	32 - 39
Westport Collection	40 - 43
Mission Collection	44 - 47
Luxe Collection	48 - 53
Squared Collection	54 - 57
Glacier Collection	58 - 61
Soho Collection	62 - 65
One By One Collection	66 - 69
Iron Collection	70 - 73
Classic Collection	74 - 81



Squared Collection, Pages 54 - 57

Product Categories

 Accent Displays	159
 Bar & Mixology Displays	230 - 237
 Beverage Dispensers	94 - 101
 Bread Displays	162 - 165
 Case Displays	166 - 175
 Cereal Dispensers	90 - 93
 Chafers & Alternatives	122 - 127
 Chalkboard Displays	220 - 221
 Cold Concept Systems	104 - 105
 Condiment & Packet Displays	190 - 199
 Covers & Trays	117 - 121
 Cup & Lid Organizers	206 - 210
 Custom & Replacement Parts	238 - 239
 Cutting Boards & Carving	180
 Dispensers	82 - 89
 Faux Cement & Slate	185 - 187
 Flatware & Condiment Displays	200 - 203
 Flatware Displays	204
 Ice Housings & Ice Carvings	134 - 143
 Ice Scoops & Holders	224 - 225
 Index	240 - 256
 Melamine Displays	110 - 113
 Melamine Platters & Bowls	114 - 116
 Merchandising Displays	160 - 161
 Mirror & Serving Stones	176 - 179
 Napkin Organizers	205
 Pitchers & Drip Trays	102 - 103
 Porcelain Displays	106 - 108

 Porcelain Platters & Bowls	109
 Riser Displays	144 - 158
 Room Service & Amenities	222 - 223
 Salad Displays & Sneezeguards	128 - 133
 Serving Boards	181 - 183
 Signage Displays	212 - 218
 Slate	184
 Straw & Toothpick Organizers	211
 Tabletop	188 - 189
 Write-On Displays	219
 Yogurt & Ice Cream	226 - 229



 Dispensers, Pages 82-89



 Faux Slate, Page 186



 Beer Tasters, Page 235

CORPORATE OFFICES
CAL•MIL
4079 Calle Platino
Oceanside, CA 92056-5805



Phone: (760) 630-5100
Toll Free: (800) 321-9069
General Fax: (760) 630-9865
For Ordering Fax: (760) 630-5010
US, Alaska, Hawaii & Canada

TERMS OF SALE

All Enclosed Prices and Terms
EFFECTIVE January 1, 2016

1. FREIGHT TERMS

All weights and measurements shown herein are approximate.
All orders are FOB Oceanside, CA.

A. FREIGHT PREPAID - CONTINENTAL USA

Freight will be prepaid on orders \$5,700 NET or more, based on a single order for a single delivery within the continental U.S. All Cal•Mil catalog products may be combined to obtain prepaid freight, excluding Custom Orders or Net Quoted pricing of catalog items.

B. FREIGHT - INTERNATIONAL

All international freight is the sole responsibility of the Broker, Dealer or any purchasing entity.

C. FREIGHT COLLECT or PREPAID AND CHARGED BACK:

All orders, not meeting Cal•Mil Prepaid Freight Policy and all Custom Manufactured Products are FOB Oceanside, CA, Freight Collect or Prepaid and Charged Back.

D. 3rd PARTY OR COLLECT FREIGHT

All 3rd party or collect shipments are solely the responsibility of the Customer. All 3rd party or collect damage claims, lost items, freight disputes or any other type of charges are the sole responsibility of the Customer. Any payments sent to CAL-MIL for claims will be forwarded to the customer in the form of a credit memo.

2. PRICES

All published prices are LIST in U.S. Dollars and are subject to change without notice. All orders will be received with the understanding that prices will be those in effect at the time of shipment. These prices are exclusive of all export fees, transportation charges, sales taxes or any special taxes which may be levied by Federal, State or City Governments.

3. RETURNS

The request to return goods must be made within 60 days of the Invoice Date. No merchandise may be returned without a written authorization number from the factory. Contact Cal•Mil Customer Service at 1-800-321-9069 to request authorization. Merchandise must be shipped Freight Prepaid by sender. All return goods must be in unused condition and packaged in their original shipping cartons and packing material. Credit issued will be based only on product returned in restockable

condition. The determination of the condition of the goods will be made solely by Cal•Mil. Custom, Discontinued or Non-standard merchandise may not be returned. **ALL RETURNS ARE SUBJECT TO A 20% RESTOCKING CHARGE.**

4. TERMS

Net 30 Days O.A.C. All orders are subject to acceptance by Cal•Mil, in accordance with our "Terms of Sale", regardless of any form in which a purchase order is submitted. All Credit Card payments subject to 3% fee.

5. MINIMUM ORDER

Minimum Order for established accounts will be \$220.00 LIST. A \$10.00 Handling Charge will be applied to all orders under \$220.00 LIST. Orders calling for Less Than Standard Pack will be charged \$5.00 NET per Broken Case.

6. CUSTOM PRODUCTS

All CUSTOM Products are FOB OCEANSIDE, CA. Finished Custom Quantities may vary by + or - 5%.

7. TITLES & DAMAGES

Merchandise will be delivered FOB Factory and title passes to buyer upon delivery of merchandise to a common carrier for shipment to buyer. Should damage occur, it is the Consignee's responsibility to notify the delivering carrier within 48 hours. Retain all cartons, packing material and merchandise for carrier inspection. Call Cal•Mil Customer Service at 1-800-321-9069 within 48 hours to notify of damage. We are willing to assist in filing claims, but the filing is Consignee's responsibility.

8. SHORTAGES/ERRORS

A. SHORTAGE OF MERCHANDISE

Contact Cal•Mil Customer Service at 1-800-321-9069 to report any shortage of merchandise within 48 hours of receipt.

B. ERRORS

Cal•Mil is not responsible for typographical errors made in the act of quoting, acknowledgements, publications or invoices. All such errors are subject to correction.

9. GENERAL

This Agreement shall be governed by the laws of the state of California.

WARNING NOTICE: Some of the products described in the Cal•Mil 2016 Catalog may contain a chemical known to the State of California to cause cancer, birth defects or other reproductive harm. Please contact us for further information.

Madera Collection

The Madera Collection is fashioned of reclaimed and redeemed wood, presenting a fresh, sustainable, one-of-a-kind design.



Industrial Madera Riser New

Reclaimed Wood (99).

ITEM	DESCRIPTION	LIST PRICE
3473-99	24Wx10Dx12H	\$220.00 ea



Madera Rectangular Risers New

Reclaimed Wood (99).

ITEM	DESCRIPTION	LIST PRICE
166-3-99	20½Wx7Dx3¼H	\$100.00 ea
166-7-99	20½Wx7Dx7H	136.00 ea
166-11-99	20½Wx7Dx11H	160.00 ea



Madera Cube Risers New

Reclaimed Wood (99).

ITEM	DESCRIPTION	LIST PRICE
432-3-99	12Wx12Dx3¼H	\$112.00 ea
432-6-99	12Wx12Dx6H	120.00 ea
432-9-99	12Wx12Dx9H	128.00 ea

a Madera Slanted Display Case 

Includes 3 — 13" x 18" Clear Trays.
Available in Attendant and Self Serve.

ITEM	DESCRIPTION	LIST PRICE
3432-99	Attendant Serve 21Wx21½Dx21½H	\$700.00 ea
3432-S-99	Self Serve 21Wx21½Dx21½H	700.00 ea
3047	Chalkboard Tents	15.50 ea
325-13-12	Replacement Tray	36.50 ea



b Madera Bread Display 

Includes 3 Clear Drawers. Can be Used Vertically or Horizontally.
Reclaimed Wood (99).

ITEM	DESCRIPTION	LIST PRICE
1204-99	8Wx13Dx20½H	\$258.00 ea
1204DRAWER	Replacement Bin	30.80 ea

c Madera 3 Tier Riser Display 

Reclaimed Wood (99).

ITEM	DESCRIPTION	LIST PRICE
3428-99	20¾Wx20¾Dx20H	\$300.00 ea



d Madera Pastry Drawers 

Sold Individually. Liner Included.

ITEM	DESCRIPTION	LIST PRICE
3416	22Wx14½Dx6½H	\$401.70 ea

e Madera Cube Risers 

Sold Individually. Reclaimed Wood (99).

ITEM	DESCRIPTION	LIST PRICE
1929-12-99	12Wx12Dx12H	\$136.00 ea

f Madera Library Display 

Removable Small Shelf. Cubes Sold Separately.
Reclaimed Wood (99).

ITEM	DESCRIPTION	LIST PRICE
1933-99	38Wx12Dx24H	\$573.70 ea



Madera Collection



Madera Porcelain Beverage Dispenser New

Base and Dispenser Sold Separately. Chalkboard Urn Sign Included with Dispenser.

ITEM	DESCRIPTION	LIST PRICE
3460-1BEV	1.5 Gallon Dispenser	\$220.00 ea
432-6-99	12Wx12Dx6H Base	120.00 ea



Madera Glass Beverage Dispenser New

Includes Glass Dispenser, Base, and Chamber.

ITEM	DESCRIPTION	LIST PRICE
3422-2	10¾Wx11½Dx22¾H - Ice	\$441.40 ea
3422-2INF	10¾Wx11½Dx22¾H - Infusion	441.40 ea



Madera Acrylic Beverage Dispenser New

3 Gallon Capacity. Reclaimed Wood (99).

ITEM	DESCRIPTION	LIST PRICE
1527-3-99	8½Wx8½Dx26¾H - Ice	\$498.20 ea
1527-3INF-99	8½Wx8½Dx26¾H - Infusion	498.20 ea



Madera Ice Housings New

Includes Clear Polycarbonate Pans. Reclaimed Wood (99).

ITEM	DESCRIPTION	LIST PRICE
3360-10	13Wx11Dx6½H	\$123.60 ea
3360-12	21Wx13Dx6½H	154.50 ea



Madera Coffee Sleeve Dispenser New

Reclaimed Wood (99).

ITEM	DESCRIPTION	LIST PRICE
2050-99	6¼Wx12¼Dx4½H	\$136.00 ea



Madera Flatware Display New

Flatware Insert is Removeable for Cleaning.

ITEM	DESCRIPTION	LIST PRICE
3408-99	9Wx6Dx5¼H	\$80.30 ea



Madera Drip Trays New

Drip Trays are Removeable for Cleaning. Reclaimed Wood (99).

ITEM	DESCRIPTION	LIST PRICE
330-4-99	4Wx4Dx1H	\$39.90 ea
330-6-99	6Wx6Dx1H	50.00 ea

a Black Iron Stand *New*

Frame Only. Fits 12Wx20D Below (Sold Separately).

ITEM	DESCRIPTION	LIST PRICE
1330-12-13	26¼Wx12½Dx27½H	\$244.30 ea



b Madera Trays *New*

3474 Does Not Fit Stands.

Reclaimed Wood (99).

ITEM	DESCRIPTION	LIST PRICE
3474-99	12Wx13Dx1½H	\$57.00 ea
1367-10-99	12Wx9¾Dx1¼H	58.00 ea
1367-12-99	19¾Wx11¾Dx1¼H	72.00 ea



c Madera Bin with Lid *New*

Includes Cover. Liner Sold Separately.

ITEM	DESCRIPTION	LIST PRICE
1332-12-99	20Wx11Dx6½H	\$150.00 ea
1332-12-INSERT	Liner	46.80 ea

d Mission 2 Tier Stand *New*

Stand Only, Bins and Trays Sold Separately.

ITEM	DESCRIPTION	LIST PRICE
1722	23Wx13Dx15H	\$270.30 ea



e Madera Tray with Handles *New*

Reclaimed Wood (99).

ITEM	DESCRIPTION	LIST PRICE
3454-1014-99	17¼Wx12½Dx5¼H	\$120.00 ea
3454-1220-99	23¼Wx14½Dx5¼H	120.00 ea



f Madera Cake Pedestal *New*

Platter and Cover Sold Separately.

ITEM	DESCRIPTION	LIST PRICE
3481-99	13DIAx4½H - Pedestal	\$80.00 ea
3488	12DIAx8½H - Bell Cover	52.00 ea
PP1167	12¾DIA Porcelain Platter	38.50 ea



visit us online at: www.calmil.com **CAL·MIL** call toll-free 800-321-9069

Madera Collection



Madera Butane Burner Stove Frame New
Iwatani Model 35FW Not Included.
Reclaimed Wood (99).

ITEM	DESCRIPTION	LIST PRICE
3435-99	12¾Wx14¾Dx6½H	\$236.00 ea



Madera Chafer Alternative New
Reclaimed Wood (99).

ITEM	DESCRIPTION	LIST PRICE
3440-99	10Wx10Dx5½H	\$220.00 ea
3439-99	20Wx10Dx5¾H	300.00 ea



3 Tier Riser Frame New
Frame Only. Shelves Sold Separately.
Specify Frame Color: Black (13), Brown (48).

ITEM	DESCRIPTION	LIST PRICE
1464	18¾Wx11Dx25H - Stand	\$210.70 ea
1449-99	Single Madera Shelf	245.90 ea



Madera Chafer New
Features Easy Access Drawer for Chafer Fuel.
Reclaimed Wood (99).

ITEM	DESCRIPTION	LIST PRICE
3429-99	23Wx14½Dx13½H	\$468.20 ea



Madera Merchandisers New
Shelves Adjustable to Sit Straight or Slanted.

ITEM	DESCRIPTION	LIST PRICE
3494-2-99	12Wx12Dx21H	\$230.00 ea
3494-3-99	12Wx12Dx31H	280.00 ea



Madera Merchandiser New
Trays are Removable.

ITEM	DESCRIPTION	LIST PRICE
3448-99	16½Wx15½Dx12H	\$300.00 ea



a Madera Cylinder Stand New

Use for Flatware or Condiments!
Cylinders Sold Separately.

ITEM	DESCRIPTION	LIST PRICE
1425-3-99	16Wx5¾Dx6H - 3 Cylinder	\$48.00 ea



b Madera Vertical Cylinder Display New

Cylinders Sold Separately.

ITEM	DESCRIPTION	LIST PRICE
3411-99	7¼Wx7¾Dx20½H	\$136.60 ea



c Madera Slanted Cylinder Stand New

Cylinders Sold Separately.

ITEM	DESCRIPTION	LIST PRICE
3423-3-99	6¼Wx14½Dx15H	\$136.60 ea



d Optional Cylinders BPA FREE

Available in Six Colors.
Specify Stainless Steel Style: Perforated (39), (Solid).
Specify Melamine Color: Black (13), White (15),
Butter Yellow (61), Terra Cotta (62), Sage (63),
Cranberry (64).

ITEM	DESCRIPTION	LIST PRICE
1017-39	4½DIAx5½H	\$14.80 ea
1017-SOLID	4½DIAx5½H	14.80 ea
1017	4½DIAx5½H	18.80 ea

e Madera Cup, Lid, and Straw Holder New

Fits Cups and Lids up to 3.75" Diameter.

ITEM	DESCRIPTION	LIST PRICE
2051-99	5½Wx19¾Dx20H	\$208.00 ea



Madera Collection



Madera Revolving Cup and Lid Organizer New

Fits Cups and Lids up to 3.75" Diameter.
Reclaimed Wood (99).

ITEM	DESCRIPTION	LIST PRICE
378-99	9Wx9Dx18½H	\$160.00 ea



2019-99

298-99
(3 Shown)

Madera Condiment Station New

Pieces Sold Separately. Reclaimed Wood (99).

ITEM	DESCRIPTION	LIST PRICE
2019-99	15¼Wx14Dx9½H	\$120.00 ea
298-99	4½Wx4½Dx8½H	48.00 ea



Madera Napkin, Cup, or Lid Organizer New

Fits Cups and Lids up to 3.75" Diameter. Two Shown, Sold Individually. Reclaimed Wood (99).

ITEM	DESCRIPTION	LIST PRICE
298-99	4½Wx4½Dx8½H	\$48.00 ea



3367-99
Base



Stainless Steel Cold Bowls ❄️

Gel-Filled, Keep in Freezer for Minimum of 6 Hours to Keep Contents Cold for Hours! Base Sold Separately Below.

ITEM	DESCRIPTION	LIST PRICE
3326-7-55	7Wx7Dx4H	\$96.40 ea
3326-10-55	10Wx10Dx4H	139.30 ea



3402

3064

3367-99

Madera Cold Concept ❄️ New

Keep Contents Cold for Hours Without the Hassle of Ice! Base and Cold Plates/Bowls Sold Separately.

ITEM	DESCRIPTION	LIST PRICE
Base		
3367-99	12Wx12Dx4½H	\$123.60 ea
Cold Bowl/Plate Options		
3063	Porcelain Plate, Liner, Cold Pack	\$129.20 ea
3064	Porcelain Bowl, Liner, Cold Pack	144.60 ea
3326-10-55	10" Stainless Cold Bowl	139.30 ea
3402	Hinged Dome Cover	56.70 ea



Samples of Cold Concept Cold Pack System



3402

3063

3367-99

a Madera Condiment Organizers *New*

Reclaimed Wood (99).

ITEM	DESCRIPTION	LIST PRICE
2053-99	6Wx7Dx16H	\$108.00 ea
2054-99	11Wx7Dx16H	132.00 ea



b Madera Slanted Organizer *New*

Middle Shelf is Removable to Create More Space.
Reclaimed Wood (99).

ITEM	DESCRIPTION	LIST PRICE
2052-99	6Wx13Dx15H	\$172.00 ea



c Madera Bar Organizer *New*

Reclaimed Wood (99).

ITEM	DESCRIPTION	LIST PRICE
3499-99	10¾Wx7Dx4¾H	\$85.00 ea

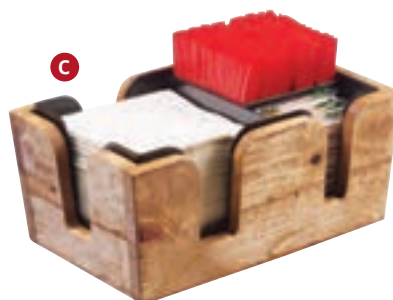

d Madera Stir-Stick/ Packet Organizer *New*

Reclaimed Wood (99).

ITEM	DESCRIPTION	LIST PRICE
796-99	9½Wx6½Dx4½H	\$58.20 ea

e Madera Stir-Stick Organizer *New*

Reclaimed Wood (99).

ITEM	DESCRIPTION	LIST PRICE
3308-99	5¼Wx5¼Dx5½H	\$60.00 ea

f Madera Multi-Section Organizer *New*

Reclaimed Wood (99).

ITEM	DESCRIPTION	LIST PRICE
1714-99	12Wx12Dx5½H	\$110.00 ea

g Madera Condiment Caddy *New*

Reclaimed Wood (99).

ITEM	DESCRIPTION	LIST PRICE
3398-99	9½Wx7½Dx5H	\$80.30 ea



visit us online at: www.calmil.com **CAL·MIL** call toll-free 800-321-9069

Madera Collection



Madera Taster Caddy New

2.25" Cut Outs for Glasses.
Customization is Always Possible!
Glasses Not Included.

ITEM	DESCRIPTION	LIST PRICE
3480-99	13Wx4Dx2½H	\$28.00 ea
3062-15	White Chalkboard Pen	12.40 ea



Madera Write-On Tasting Board New

2.25" Cut Outs for Glasses.
Customization is Always Possible!
Glasses Not Included.

ITEM	DESCRIPTION	LIST PRICE
2063	12Wx6Dx¾H	\$26.80 ea
3062-15	White Chalkboard Pen	12.40 ea



Madera Jar Displays New

Includes 3 Glass Jars,
Chalkboard Stick-On's Sold Separately.

ITEM	DESCRIPTION	LIST PRICE
3406-3	14Wx5½D3H	\$133.90 ea
3406-6	14Wx5½D6H	144.20 ea

Optional Chalkboard Stick-On and Pens

Includes Double Sided Tape

3057	3Wx2D	\$15.50 ea
3062-15	White Chalkboard Pen	12.40 ea



Madera Write-On Tasting Crate New

Customization is Always Possible!
Glasses Not Included.

ITEM	DESCRIPTION	LIST PRICE
3058	10¼Wx3¾D2¾H	\$28.80 ea
3062-15	White Chalkboard Pen	12.40 ea



a Madera Cardholders and Chalkboard Stands *New*

ITEM	DESCRIPTION	LIST PRICE
Cardholders		
3483-23-99	3½Wx2H	\$24.00 ea
3483-46-99	4Wx6H	32.00 ea
3483-811-99	8½Wx11H	48.00 ea
Chalkboard		
3489-23-99	3½Wx2H	\$24.00 ea
3489-46-99	4Wx6H	32.00 ea
3489-811-99	8½Wx11H	48.00 ea
3062-15	White Chalkboard Pen	12.40 ea



b Madera Three Section Cereal Dispenser *New*

600 Cubic Inch Capacity Per Bin.

ITEM	DESCRIPTION	LIST PRICE
3434-99	18Wx14½Dx24H	\$800.00 ea

c Madera Beverage Cart *New*

Cart Only. Beverage Dispenser Sold Separately. Center Section of Cart Pulls Out for Easy Access.

ITEM	DESCRIPTION	LIST PRICE
3461-99	27Wx16Dx41H - Cart	\$1,200.00 ea
3553ICE	Glass Dispenser w/ Ice Chamber	278.10 ea
3553INF	Glass Dispenser w/ Infusion Chamber	278.10 ea
3550	Chalkboard Beverage Sign	17.80 ea
1717-15	White Tabletop Trash Can	37.00 ea



d Madera Single Jar Risers *New*

ITEM	DESCRIPTION	LIST PRICE
3427-3-99	4¼Wx4¼D3H	\$50.00 ea
3427-5-99	4¼Wx4¼D5H	50.00 ea
3427-7-99	4¼Wx4¼D7H	50.00 ea
C4X4GLCN	Replacement Glass Jar	19.50 ea



visit us online at: www.calmil.com **CAL·MIL** call toll-free 800-321-9069

Urban Collection

Constructed of Stainless Steel & dramatic rivet accents, the Urban Collection combines industrial and modern styles.



Urban Beverage Dispenser

3 Gallon Capacity.
Includes Chamber and Drip Tray.
Stainless Steel (55).

ITEM	DESCRIPTION	LIST PRICE
Ice Chamber		
3394-3-55	8Wx8Dx24H	\$498.20 ea
Infusion Chamber		
3394-3INF-55	8Wx8Dx24H	498.20 ea

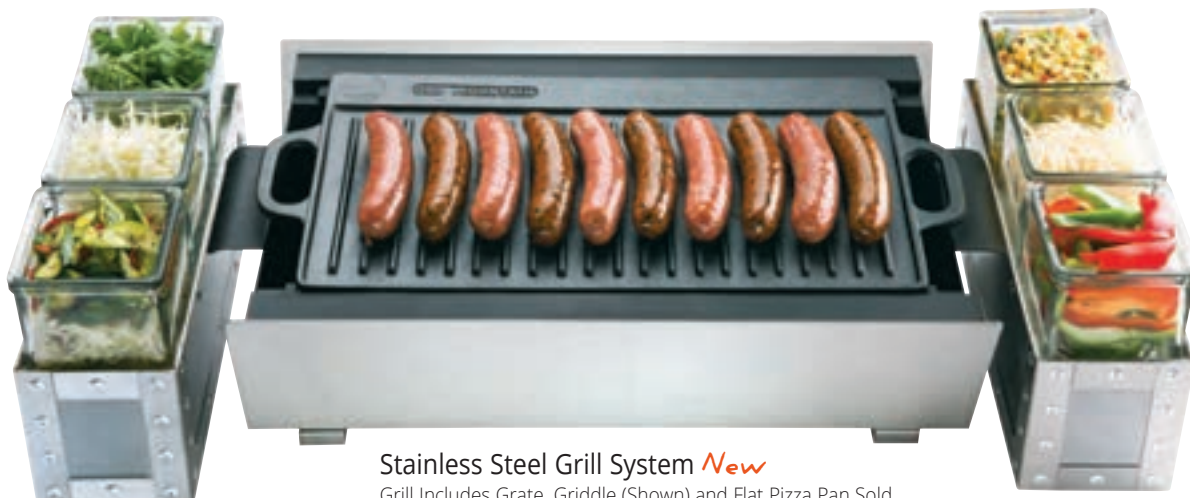

Stainless Steel Grill System *New*

Grill Includes Grate. Griddle (Shown) and Flat Pizza Pan Sold Separately. Use with Canned Chafer Fuel.

ITEM	DESCRIPTION	LIST PRICE
3451-55	23Wx12¼Dx7H - Grill	\$350.00 ea
3412-5-55	13Wx13Dx5H - Urban 3 Jar Riser	154.50 ea
Grill Options		
3451-55FLAT	Aluminum Teflon Coated Griddle	48.00 ea
3451-55GRIDDLE	Double Sided Cast Iron Griddle	60.00 ea



a

a Urban Butane Burner Housing

Iwatani Model 35FW Not Included.
Stainless Steel (55).

ITEM	DESCRIPTION	LIST PRICE
3390-55	14Wx12½Dx7¼H	\$227.30 ea



b

b Urban Chafer

Includes Stainless Steel Cover.
Stainless Steel (55).

ITEM	DESCRIPTION	LIST PRICE
3396-55	23Wx14½Dx13½H	\$500.10 ea
3325-55	Replacement Chafer Cover	299.90 ea



c

c Urban Chafer Alternatives

Stainless Steel (55)

ITEM	DESCRIPTION	LIST PRICE
3407-55	12Wx12Dx8¾H	\$204.60 ea
3391-55	22Wx7½Dx8¾H	283.30 ea



3367-55
Base

d Stainless Steel Cold Bowls ❄️

Gel-Filled, Keep in Freezer for Minimum
of 6 Hours to Keep Contents Cold for Hours!

ITEM	DESCRIPTION	LIST PRICE
3326-7-55	7Wx7Dx4H	\$96.40 ea
3326-10-55	10Wx10Dx4H	139.30 ea



3064

3367-55

e Urban Cold Concept ❄️

Keep Contents Cold for Hours!
Base and Cold Plates/Bowls Sold Separately.
Stainless Steel (55).

ITEM	DESCRIPTION	LIST PRICE
3367-55	12Wx12Dx4½H	\$164.80 ea

Cold Bowl/Plate Options

3063	Porcelain Plate, Liner, Cold Pack	\$129.20 ea
3064	Porcelain Bowl, Liner, Cold Pack	144.60 ea
3326-10-55	Stainless Steel Cold Bowl	139.30 ea
3402	Hinged Dome Cover	56.70 ea



Sample of Cold Concept Cold Pack System

3402

3063

3367-55

Urban Collection



Urban Bread Displays

Stackable. Stainless Steel (55).

ITEM	DESCRIPTION	LIST PRICE
3410-55	6¾Wx12¼Dx6¾H	\$164.80 ea



Urban Case Display

Includes 3 — 13" x 18" Clear Trays. Stainless Steel (55).

ITEM	DESCRIPTION	LIST PRICE
3413-55	19¼Wx14¼Dx19¼H	\$536.60 ea
325-13-12	Replacement Tray	36.50 ea



Square Stainless Steel Cold Sampler

Includes Plate, Flip Lid, Cold Packs and Liners to Keep Contents Cold.

ITEM	DESCRIPTION	LIST PRICE
3329-12-55	12Wx13Dx7½H	\$230.40 ea
CC3329	Replacement Cold Pack & Liner	87.80 ea



Optional Cylinders BPA FREE

Available in Six Colors. Specify Stainless Steel Style: Perforated (39), (Solid). Specify Melamine Color: Black (13), White (15), Butter Yellow (61), Terra Cotta (62), Sage (63), Cranberry (64).

ITEM	DESCRIPTION	LIST PRICE
1017-39	4½DIAx5½H	\$14.80 ea
1017-SOLID	4½DIAx5½H	14.80 ea
1017	4½DIAx5½H	18.80 ea



Urban Cylinder Display

Cylinders Sold Separately. Stainless Steel (55).

ITEM	DESCRIPTION	LIST PRICE
3411-55	6¾Wx7¾Dx20¼H	\$154.50 ea



Urban Cereal Dispenser

Stainless Steel (55).

ITEM	DESCRIPTION	LIST PRICE
3401-55	17½Wx13½Dx24H	\$1,081.50 ea



a Urban Ice Housings

Includes Clear Polycarbonate Pan.
Stainless Steel (55).

ITEM	DESCRIPTION	LIST PRICE
3395-10-55	12¾Wx10¾Dx6¾H	\$416.80 ea
3395-12-55	20¾Wx12¾Dx7¾H	460.70 ea



b Urban Cup/Lid Organizer

Fits Cups and Lids Up to 3.75." Revolving.
Stainless Steel (55).

ITEM	DESCRIPTION	LIST PRICE
3393-55	7¾Wx7¾Dx18H	\$159.00 ea



c Urban Stair-Step Jar Display

Includes 3 Glass Jars.
Stainless Steel (55).

ITEM	DESCRIPTION	LIST PRICE
3412-3-55	13Wx13Dx3H	\$154.50 ea
3412-5-55	13Wx13Dx5H	154.50 ea
3412-7-55	13Wx13Dx7H	154.50 ea
C4X4GLCN	Replacement Glass Jar	19.50 ea

d Urban Jar Risers

Includes 1 Glass Jar.
Stainless Steel (55).

ITEM	DESCRIPTION	LIST PRICE
3405-3-55	4¾Wx4¾Dx3H	\$67.00 ea
3405-5-55	4¾Wx4¾Dx5H	67.00 ea
3405-7-55	4¾Wx4¾Dx7H	67.00 ea
C4X4GLCN	Replacement Glass Jar	19.50 ea



e Urban Flatware Organizer

Stainless Steel (55).

ITEM	DESCRIPTION	LIST PRICE
3408-55	8¾Wx5¼Dx6H	\$80.30 ea



f Urban Packet and
Condiment Organizer

Stainless Steel (55).

ITEM	DESCRIPTION	LIST PRICE
3398-55	9Wx6Dx5¼H	\$80.30 ea



g Urban Large
Condiment Organizer

Stainless Steel (55).

ITEM	DESCRIPTION	LIST PRICE
3409-55	12Wx12Dx4H	\$144.20 ea



Bamboo Collection

Presenting the freshest and most natural material, the Bamboo Collection is elegant and environmentally friendly.



Bamboo Square Crate Risers

These Risers Can Also be Used as Bins and Work with Our Bamboo Shelves (See Page 18).

ITEM	DESCRIPTION	LIST PRICE
1944-6-60	6Wx6Dx6H	\$39.80 ea
1944-9-60	9Wx9Dx9H	79.50 ea
1944-12-60	12Wx12Dx12H	132.40 ea
3332-4-60	12Wx12Dx4H	96.40 ea
3332-7-60	12Wx12Dx7H	107.10 ea
3332-10-60	12Wx12Dx10H	139.30 ea



Bamboo Rectangle Crate Risers

These Risers Can Also be Used as Bins and Work with Our Bamboo Shelves (See Page 18).

ITEM	DESCRIPTION	LIST PRICE
1943-3-60	20Wx7Dx3H	\$73.80 ea
1943-7-60	20Wx7Dx7H	119.10 ea
1943-11-60	20Wx7Dx11H	132.40 ea



Bamboo Acrylic Beverage Dispenser BPA FREE

1.5 and 3 Gallon Capacity. Includes Drip Tray and Works with Our Bamboo Shelves (See Page 18).

ITEM	DESCRIPTION	LIST PRICE
Ice Chamber		
1527-1-60	8¼Wx9¾Dx17¾H	\$462.70 ea
1527-3-60	8¼Wx9¾Dx26¾H	498.20 ea
Infusion Chamber		
1527-1INF-60	8¼Wx9¾Dx17¾H	462.70 ea
1527-3INF-60	8¼Wx9¾Dx26¾H	498.20 ea

Bamboo Crate Acrylic Beverage Dispenser BPA FREE

3 Gallon Capacity. Works with Our Bamboo Shelves (See Page 18).

ITEM	DESCRIPTION	LIST PRICE
Ice Chamber		
3301-3-60	8Wx8Dx25½H	\$498.20 ea
Infusion Chamber		
3301-3INF-60	8Wx8Dx25½H	498.20 ea



Bamboo Cube Riser

ITEM	DESCRIPTION	LIST PRICE
432-3-60	12Wx12Dx3H	\$86.00 ea
432-6-60	12Wx12Dx6H	98.40 ea
432-9-60	12Wx12Dx9H	110.50 ea

Bamboo Rectangle Riser

ITEM	DESCRIPTION	LIST PRICE
166-3-60	20Wx7Dx3H	\$73.50 ea
166-7-60	20Wx7Dx7H	119.00 ea
166-11-60	20Wx7Dx11H	131.60 ea



Bamboo 4 Drawer Bread Case

Bamboo Frame, Acrylic Drawers.

ITEM	DESCRIPTION	LIST PRICE
1718-60	16½Wx15Dx15H	\$604.10 ea
C1718DRAWER	Replacement Drawer	58.10 ea

284-60

Bamboo Bakery Display Cases

Includes 3 — 13" x 18" Clear Trays. Available in Attendant and Self Serve.

ITEM	DESCRIPTION	LIST PRICE
284-60	21Wx16¼Dx22½H	\$1,040.60 ea
284-S-60	21Wx16¼Dx22½H	1,040.60 ea
325-13-12	Replacement Tray	36.50 ea



Bamboo Drip Trays

Drip Trays are Removable for Cleaning.

ITEM	DESCRIPTION	LIST PRICE
330-4-60	4Wx4Dx1H	\$39.90 ea
330-6-60	6Wx6Dx1H	50.00 ea



Bamboo Cold Jar Display

Includes Base, Jars, Lids, and Cooling Pucks. Specify Lid Type.

ITEM	DESCRIPTION	LIST PRICE
1850-4-60	16Wx6Dx4H-w/ Solid Lid	\$144.60 ea
1850-4-60HL	16Wx6Dx4H- w/ Hinged Lid	171.40 ea



visit us online at: www.calmil.com **CAL·MIL** call toll-free 800-321-9069

Bamboo Collection



Bamboo Crate Risers

Platters are Sold Separately.

ITEM	DESCRIPTION	LIST PRICE
3331-60	9Wx9Dx18H	\$171.40 ea
3332-4-60	12Wx12Dx4H	96.40 ea
3332-7-60	12Wx12Dx7H	107.10 ea
3332-10-60	12Wx12Dx10H	139.30 ea

Bamboo Shelves

ITEM	DESCRIPTION	LIST PRICE
1435-1224-60	12Wx24Dx½H	\$108.80 ea
1435-1232-60	12Wx32Dx½H	139.30 ea
1435-1248-60	12Wx48Dx½H	154.50 ea
C732-60	7Wx32Dx½H	86.90 ea

Large Porcelain Square Platter

ITEM	DESCRIPTION	LIST PRICE
PP252	11Wx11Dx1H	\$40.80 ea



3331-60



3332-10-60



3332-7-60



3332-4-60



Cold Concept Cold Pack System

Cold Concept Set

Complete Set Includes: Porcelain Plate, Liner, and Cold Pack. Place Cold Pack in Freezer for a Minimum of 6 Hours. Keeps Contents Cold for 2-3 Hours.

ITEM	DESCRIPTION	LIST PRICE
3063	Porcelain Plate, Liner, Cold Pack	129.20 ea
3402	Hinged Dome Cover	56.70 ea



a Medium Porcelain Square Bowl

ITEM	DESCRIPTION	LIST PRICE
PP251	8Wx8Dx2H	\$27.50 ea

b Porcelain or Melamine Platter

ITEM	DESCRIPTION	LIST PRICE
PP252	11Wx11Dx1H - Porcelain	\$40.80 ea
SR252	11Wx11Wx1H - Melamine	37.50 ea

c Round Porcelain Platter

ITEM	DESCRIPTION	LIST PRICE
PP1167	12¾DIAx1½H	\$38.50 ea

d Small Round Porcelain Bowl

ITEM	DESCRIPTION	LIST PRICE
PP1153	4DIAx2H	\$18.70 ea

e Porcelain and Melamine Platters

ITEM	DESCRIPTION	LIST PRICE
SR152	23Wx7Dx1H - Melamine	\$67.30 ea
PP150	18Wx3Dx1H - Porcelain	51.80 ea
PP152	23Wx7Dx1H - Porcelain	94.90 ea

f Round Melamine Jars

Specify Color: Black (13), White (15).

ITEM	DESCRIPTION	LIST PRICE
1950-16	4DIAx4¼H - 16 oz.	\$18.80 ea
1950-32	5DIAx5½H - 32 oz.	25.30 ea
1950-64	6¾DIAx6¼H - 64 oz.	34.20 ea

g Round Melamine Jars w/ Write-On

Label is Commercial Grade, Scratch and Dent Proof!

ITEM	DESCRIPTION	LIST PRICE
1950-16-15C	4DIAx4¼H - 16 oz.	\$22.50 ea
1950-32-15C	5DIAx5½H - 32 oz.	28.90 ea
1950-64-15C	6¾DIAx6¼H - 64 oz.	38.00 ea

h Square Melamine Jars

ITEM	DESCRIPTION	LIST PRICE
C1432BODY	4Wx4Dx4H Jar Only	\$14.80 ea
1432-15	4Wx4Dx4H Jar w/Full Lid	22.90 ea
1432-15N	4Wx4Dx4H Jar w/Notched Lid	22.90 ea

i Square Melamine Jars w/ Write-On

Label is Commercial Grade, Scratch and Dent Proof!

ITEM	DESCRIPTION	LIST PRICE
C1432BODYC	4Wx4Dx4H Jar Only	\$18.30 ea
1432-15C	4Wx4Dx4H Jar w/Full Lid	26.20 ea
1432-15N-C	4Wx4Dx4H Jar w/Notched Lid	26.20 ea



f White and Black Round Jars

g Round Write On

h Square White Only

i Square Write On

Bamboo Collection



Bamboo Revolving Cup/Lid Organizers

Holds up to 3.75" Diameter Cups & Lids.

ITEM	DESCRIPTION	LIST PRICE
1468	9Wx9Dx18½H	\$140.40 ea
378-60	8Wx8Dx18¼H	110.50 ea



Bamboo Coffee Sleeve Dispenser

ITEM	DESCRIPTION	LIST PRICE
2050-60	5¾Wx12Dx3¾H	\$123.20 ea



Bamboo Cup, Lid, and Straw Holder

ITEM	DESCRIPTION	LIST PRICE
2051-60	4½Wx20Dx19½H	\$225.00 ea



4 Section Bamboo Cup and Lid Holder

ITEM	DESCRIPTION	LIST PRICE
2048-4-60	4½Wx20Dx19½H	\$225.00 ea



3 Section Bamboo Cup and Lid Holder

ITEM	DESCRIPTION	LIST PRICE
2048-3-60	4½Wx17Dx16¼H	\$192.80 ea

a Bamboo Flatware Condiment Display

Dimensions: 5¼Wx14Dx18H.
Includes 3 Bamboo Bins.

ITEM	DESCRIPTION	LIST PRICE
1235-13-60	Black Frame	\$158.60 ea
1235-39-60	Platinum Frame	158.60 ea
1234	Replacement Bin	27.00 ea



b 9 Bin Tiered Display

Includes 9 Bamboo Bins.
Specify Frame Color: Black (13), Platinum (39).

ITEM	DESCRIPTION	LIST PRICE
1817	13Wx9½Dx17½H	\$258.00 ea
C4X4-60	Replacement Bin	18.90 ea



c Bamboo Stir Stick and Condiment Organizer

Divider is Removable to Create More Capacity.

ITEM	DESCRIPTION	LIST PRICE
2052-60	5½Wx13¼Dx14¼H	\$192.80 ea

d Bamboo Lid Display

Holds up to 4" Diameter Cups & Lids.

ITEM	DESCRIPTION	LIST PRICE
298-60	4½Wx4½Dx8H	\$39.80 ea

e Bamboo Beverage Signs

Dimensions: 3"W x 1"D x 2"H.

ITEM	DESCRIPTION	LIST PRICE
606-1	COFFEE	\$11.30 ea
606-2	DECAF	11.30 ea
606-3	HOT WATER	11.30 ea
606-4	TEA	11.30 ea



visit us online at: www.calmil.com **CAL·MIL** call toll-free 800-321-9069

Bamboo Collection



2054-60

Bamboo Condiment Organizers

ITEM	DESCRIPTION	LIST PRICE
2053-60	7Wx5Dx16H	\$92.70 ea
2054-60	10¼Wx6¾Dx16½H	128.80 ea



2053-60

Bamboo Jar Display

Includes Three Square Glass Jars.

ITEM	DESCRIPTION	LIST PRICE
1486	5Wx14Dx13H	\$149.90 ea
C4x4GLCN	Replacement Jar	19.50 ea



Bamboo Dual Airpot Display

Includes 2 Drip Trays. Airpots Not Included.

ITEM	DESCRIPTION	LIST PRICE
360-2-60	7½Wx23½D15¼H	\$158.80 ea



Bamboo Compartment Spacesaver New

Cylinders Sold Separately.
Use for Condiments or Flatware.

ITEM	DESCRIPTION	LIST PRICE
1426-60	12Wx14Dx16¼H	\$220.00 ea



Bamboo Compartment Spacesaver

Cylinders Sold Separately.
Use for Condiments or Flatware.

ITEM	DESCRIPTION	LIST PRICE
1016-3-60	6¼Wx9¾Dx22¾H	\$136.60 ea

Optional Cylinders

Available in Six Colors.
Specify Stainless Steel Style: Perforated (39), (Solid).
Specify Melamine Color: Black (13), White (15),
Butter Yellow (61), Terra Cotta (62), Sage (63),
Cranberry (64).

ITEM	DESCRIPTION	LIST PRICE
1017-39	4½DIAx5½H	\$14.80 ea
1017-SOLID	4½DIAx5½H	14.80 ea
1017	4½DIAx5½H	18.80 ea



Adjustable Condiment Caddy

Cylinders Sold Separately.
Rings are Removable and Adjustable.

ITEM	DESCRIPTION	LIST PRICE
3371	10½Wx5¾Dx21H	\$164.80 ea

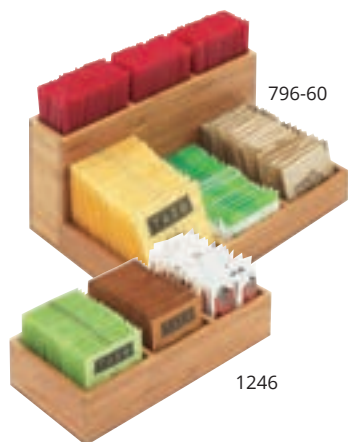

796-60

Bamboo Packet Organizer

ITEM	DESCRIPTION	LIST PRICE
1246	9½Wx4½Dx2½H	\$29.60 ea
796-60	9Wx6¼Dx4½H	58.20 ea



Bamboo 9 Section Condiment Organizer

ITEM	DESCRIPTION	LIST PRICE
1714-60	12Wx12Dx5½H	\$73.90 ea



298-60
(3 Shown)

2019-60

Bamboo Condiment Station

Pieces Sold Separately.

ITEM	DESCRIPTION	LIST PRICE
2019-60	15Wx14¼Dx19¾H	\$93.70 ea
298-60	4½Wx4½Dx8H	39.80 ea



Bamboo Write-On/Cardholder

Use Dry or Wet Erase Markers.

ITEM	DESCRIPTION	LIST PRICE
1103-23-60	3½Wx2H - Write-On	\$18.20 ea
1103-811-60	8½Wx11H - Write-On	34.10 ea
1103-23-12	3½Wx2H - Cardholder	18.20 ea
1103-811-12	8½Wx11H - Cardholder	34.10 ea
1543-60	Base for 3½Wx2H Card	5.10 ea



Bamboo Base Cardholder

Bamboo Base, Acrylic Signholder.

ITEM	CARD SIZE	LIST PRICE
1510-32-60	3½Wx2H	\$20.00 ea
1510-411-60	4Wx11H	29.40 ea
1510-46-60	4Wx6H	21.40 ea
1510-811-60	8½Wx11H	34.70 ea



Bamboo Room Service Tray

ITEM	DESCRIPTION	LIST PRICE
958-1-60	22½Wx17Dx1½H	\$66.20 ea



1234

Bamboo Napkin Displays

ITEM	NAPKIN SIZE	LIST PRICE
3309-60	5Wx5H	\$38.50 ea
1234	4Wx8H	27.00 ea



Bamboo Flatware Display

ITEM	CARD SIZE	LIST PRICE
1244	8¼Wx5½DX4¾H	\$58.20 ea



3308-60

3307-60

Bamboo Straw Organizers

ITEM	DESCRIPTION	LIST PRICE
3307-60	5Wx5Dx3½H	\$58.20 ea
3308-60	5Wx5Dx5½H	58.20 ea

Bamboo Collection



Bamboo 2 Drawer Bread Case

Stackable; Bamboo Frame, Acrylic Drawers.

ITEM	DESCRIPTION	LIST PRICE
1337-60	14Wx13½Dx5¾H	\$452.40 ea



Iron/Bamboo Risers

ITEM	DESCRIPTION	LIST PRICE
1711-3-60	12Wx12Dx3H	\$98.40 ea
1711-5-60	12Wx12Dx5H	100.80 ea
1711-7-60	12Wx12Dx7H	110.50 ea



Bamboo Crumb Catcher

Top Removable for Cleaning.

ITEM	DESCRIPTION	LIST PRICE
823	13¾Wx8Dx1½H	\$37.00 ea



Bamboo Tray and Riser

Fits Standard Muffin Pan. Pieces Sold Separately.

ITEM	DESCRIPTION	LIST PRICE
1339-60	16Wx11Dx2H - Tray	\$101.60 ea
1339-RISER	9Wx8¼Dx2H - Riser	33.90 ea

a Bamboo Square/Rectangular Change Up Risers

Risers and Tray Inserts Sold Separately.

ITEM	DESCRIPTION	LIST PRICE
Risers		
1476-10	10½Wx10½Dx4H - Square/Small	\$124.10 ea
1476-12	12½Wx12½Dx6H - Square/Large	128.80 ea
1562-2	21¼Wx7¾Dx2¼H - Rectangle/Small	136.40 ea
1562-4	21¼Wx7¾Dx4½H - Rectangle/Medium	136.40 ea
1562-6	21¼Wx7¾Dx6¼H - Rectangle/Large	136.40 ea

Optional Bamboo Inserts - Deep and Flat Trays

1481-10-60	Small Square Flat Tray	\$28.00 ea
1481-12-60	Large Square Flat Tray	32.80 ea
1477-10-60	Small Square Deep Tray - 2¾"H	42.10 ea
1477-12-60	Large Square Deep Tray - 3¼"H	46.80 ea
166-3-60	Rectangle Deep Tray - 3"H	73.50 ea



b Bamboo Risers

Specify Top: Corian or Underlit w/ Frost.

ITEM	DESCRIPTION	LIST PRICE
3028-60	10½Wx10½Dx8H - w/ Corian Top	\$206.00 ea
3028-60L	10½Wx10½Dx8H - Underlit w/ Frost	206.00 ea
3029-60	12Wx12Dx7H - w/ Corian Top	236.90 ea
3029-60L	12Wx12Dx7H - Underlit w/ Frost	236.90 ea



3367-60 Base



c Stainless Steel Cold Bowls

Gel-Filled, Keep in Freezer for Minimum of 6 Hours to Keep Contents Cold for Hours!

ITEM	DESCRIPTION	LIST PRICE
3326-7-55	7Wx7Dx4H	\$96.40 ea
3326-10-55	10Wx10Dx4H	139.30 ea



d Bamboo Cold Concept

Keep Contents Cold for Hours!
Base and Cold Plates/Bowls Sold Separately.

ITEM	DESCRIPTION	LIST PRICE
Base		
3367-60	12Wx12Dx4½H	\$123.60 ea
Cold Bowl/Plate Options		
3063	Porcelain Plate, Liner, Cold Pack	\$129.20 ea
3064	Porcelain Bowl, Liner, Cold Pack	144.60 ea
3402	Hinged Dome Cover	56.70 ea



Samples of Cold Concept Cold Pack System

visit us online at: www.calmil.com **CAL·MIL** call toll-free 800-321-9069

Bamboo Collection



Bamboo Cupcake Display

ITEM	DESCRIPTION	LIST PRICE
1318-60	20Wx20Dx17¼H	\$204.60 ea



Easy Set Up
& Breakdown



Large Bamboo Cupcake Display

Bamboo Tiered Base w/Clear Shelves.

ITEM	DESCRIPTION	LIST PRICE
1284-60	24Wx24Dx14½H	\$359.60 ea

Bamboo Cylinder Stand

3 or 6 Cylinders Available.
Cylinders Sold Separately.

ITEM	DESCRIPTION	LIST PRICE
1425-3-60	16Wx5½Dx6H - 3 Cylinder	\$35.00 ea
1425-6-60	16Wx11Dx6H - 6 Cylinder	56.10 ea



Optional Cylinders BPA FREE

Available in Six Colors.
Specify Stainless Steel Style: Perforated (39), (Solid).
Specify Melamine Color: Black (13), White (15),
Butter Yellow (61), Terra Cotta (62), Sage (63),
Cranberry (64).

ITEM	DESCRIPTION	LIST PRICE
1017-39	4½DIAx5½H	\$14.80 ea
1017-SOLID	4½DIAx5½H	14.80 ea
1017	4½DIAx5½H	18.80 ea



Bamboo Elevation Stand

ITEM	DESCRIPTION	LIST PRICE
1930-60	18Wx18Dx20¼H	\$441.40 ea



Bamboo Glass Jar Holder

Includes 3 Glass Jars & Lids.

ITEM	DESCRIPTION	LIST PRICE
1338-60	13Wx5Dx5½H	\$231.80 ea

Optional Acrylic Lids & Replacement Jars

1811	Solid-Soft Hinge	\$7.30 ea
1811-N	Notched-Soft Hinge	7.30 ea
1807	Solid-Metal Hinge	10.50 ea
1807-N	Notched-Metal Hinge	10.50 ea
C4x4GLCN	Replacement Jar	19.50 ea



Bamboo Counter Trash Bin

ITEM	DESCRIPTION	LIST PRICE
1717-60	5Wx5Dx7H	\$37.00 ea

a Bamboo Ice Housings 

Includes Clear Polycarbonate Pans.

ITEM	DESCRIPTION	LIST PRICE
475-6-60	6Wx7Dx6½H	\$69.20 ea
475-10-60	10Wx12Dx6½H	121.80 ea
475-12-60	12Wx20Dx6½H	156.90 ea



b Bamboo Library Display 

Removable Small Shelf. Cube Sold Separately.

ITEM	DESCRIPTION	LIST PRICE
1933-60	38Wx12Dx24H	\$573.70 ea

Cube Sold Separately



c Bamboo Library Cubes 

Sold Individually.

ITEM	DESCRIPTION	LIST PRICE
1929-12-60	12Wx12Dx12H	\$121.30 ea



d Swivel Bamboo Riser 

Risers Swivel to Create More Options!

ITEM	DESCRIPTION	LIST PRICE
3347-3-60	12DIAx11H	\$329.60 ea



Bamboo Riser with Swivel Shelves

visit us online at: www.calmil.com **CAL·MIL** call toll-free 800-321-9069

Bamboo Collection



Bamboo Simplicity Mobile Server

Customization is Always Available!

ITEM	DESCRIPTION	LIST PRICE
1412-60	60Wx32Dx30H	\$3,072.60 ea



Union Square Risers

Bamboo Shelf Sold Separately.

ITEM	DESCRIPTION	LIST PRICE
3358-13	5Wx14Dx10 - Set of 2	\$133.90 ea
C732-60	7Wx32Dx¼H - Bamboo Shelf	86.90 ea



Bamboo Multi-Level Shelf Display

Bamboo Shelves are Removable for Cleaning.

ITEM	DESCRIPTION	LIST PRICE
3303-60	28½Wx13½Dx36½H - Black Frame	\$642.70 ea
3304-60	28½Wx13½Dx36½H - Silver Frame	642.70 ea

a 2 Tier Iron Stand 

12Wx20D Bins and Trays Sold Separately.

ITEM	DESCRIPTION	LIST PRICE
1330-12-13	26¼Wx12½Dx27½H	\$244.30 ea

b Bamboo Roll Top Cover 

ITEM	DESCRIPTION	LIST PRICE
1333-60	20Wx11½Dx6½H	\$191.80 ea

c Bamboo Trays

ITEM	DESCRIPTION	LIST PRICE
1367-10-60	9¾Wx12Dx1¼H	\$43.10 ea
1367-12-60	11¾Wx19¾Dx1¼H	55.40 ea

d Bamboo Bins with Lid

ITEM	DESCRIPTION	LIST PRICE
1332-12-60	20Wx12Dx7H	\$79.90 ea
1332-12-INSERT	Liner for 12x20 Bin	46.80 ea



e Bamboo Wet Floor Sign 

Two-Sided.

ITEM	DESCRIPTION	LIST PRICE
852-60	12Wx17½Dx22H	\$221.10 ea

f Mission 2 Tier Stand 

Stand Only, Trays Sold Separately.

ITEM	DESCRIPTION	LIST PRICE
1722	23Wx13Dx15H	\$270.30 ea
1367-12-60	Bamboo Tray	55.40 ea

g Bamboo Stair-Step Risers 

ITEM	DESCRIPTION	LIST PRICE
3374-4-60	24Wx10Dx4H	\$164.80 ea
3374-8-60	24Wx10Dx8H	175.10 ea
3374-12-60	24Wx10Dx12H	185.40 ea



visit us online at: www.calmil.com **CAL·MIL** call toll-free 800-321-9069

Eco Modern Collection

Eco Modern Collection joins platinum metal designs and environmentally friendly materials.



Eco Modern Bread Case

ITEM	DESCRIPTION	LIST PRICE
1279	14Wx11½Dx15H	\$374.60 ea
1480	Replacement Bin w/ Drawers	101.50 ea
C1480DRAWER	Replacement Drawer	67.40 ea



Eco Modern 2 Tier Merchandiser

ITEM	DESCRIPTION	LIST PRICE
1278	14Wx11½Dx15H	\$187.30 ea



1474 w/ (9) 1432-15

Eco Modern 9 Jar Display

Frame and Jars Sold Separately.

ITEM	DESCRIPTION	LIST PRICE
1474	14Wx13½Dx7¼H - Frame	\$152.10 ea
C4x4GLCN	4Wx4D - Glass Jar	19.50 ea
1432-15	4Wx4D - Melamine Jar w/ Lid	22.90 ea
1432-15N	4Wx4D Melamine Jar w/Notched Lid	22.90 ea



1474 w/ (9) C4X4GLCN

Optional Glass Jar Lids

ITEM	DESCRIPTION	LIST PRICE
Stainless Steel Hinge		
1807	4Wx4Dx½H	\$10.50 ea
1807-N	4Wx4Dx½H - Notched	10.50 ea
Plastic Hinge		
1811	4Wx4Dx½H	7.30 ea
1811-N	4Wx4Dx½H - Notched	7.30 ea



1474



1811-N 1811

1807 1807-N



1471 Frame



1478 Bin with Cover

Eco Modern Merchandiser

Pieces Sold Individually or as a Set. Set Includes Frame, Bread Bin w/ Drawers, and Bin w/ Cover.

ITEM	DESCRIPTION	LIST PRICE
1471-SET	21Wx13Dx15H - Set	\$483.90 ea
1471	Frame	199.00 ea
1478	Bin with Cover	114.10 ea
1479	Bread Bin with Drawers	177.60 ea

1479 Bread Bin with Drawers

1471 Frame



Eco Modern Chafer

Includes Stainless Steel Chafer Cover.

ITEM	DESCRIPTION	LIST PRICE
1473	23Wx14½Dx13½H	\$468.20 ea
3325-55	Replacement Cover	299.90 ea



Eco Modern Ice Housing

Includes Clear Polycarbonate Pan.

ITEM	DESCRIPTION	LIST PRICE
1472	21¼Wx14¼Dx9H	\$383.60 ea

Eco Modern Cylinder Holder

Cylinders Sold Separately.

ITEM	DESCRIPTION	LIST PRICE
1283	6½Wx8Dx17H	\$136.40 ea

Optional Cylinders BPA FREE

Available in Six Colors.

Specify Stainless Steel Style: Perforated (39), (Solid).
Specify Melamine Color: Black (13), White (15),
Butter Yellow (61), Terra Cotta (62), Sage (63),
Cranberry (64).

ITEM	DESCRIPTION	LIST PRICE
1017-39	4½DIAx5½H	\$14.80 ea
1017-Solid	4½DIAx5½H	14.80 ea
1017	4½DIAx5½H	18.80 ea



Solid



Eco Modern Cereal Dispenser BPA FREE

ITEM	DESCRIPTION	LIST PRICE
1499	18¼Wx13¼Dx24½H	\$721.60 ea

visit us online at: www.calmil.com **CAL·MIL** call toll-free 800-321-9069

Midnight Bamboo Collection

Made of sleek, blackened bamboo, the Midnight Bamboo Collection is unique and visually impactful.



Midnight Bamboo Crate Risers

Platters are Sold Separately.

ITEM	DESCRIPTION	LIST PRICE
3331-96	9Wx9Dx18H	\$171.40 ea
3332-4-96	12Wx12Dx4H	96.40 ea
3332-7-96	12Wx12Dx7H	107.10 ea
3332-10-96	12Wx12Dx10H	139.30 ea

Midnight Bamboo Shelves

ITEM	DESCRIPTION	LIST PRICE
1435-1224-96	12Wx24Dx½H	\$108.80 ea
1435-1232-96	12Wx32Dx½H	139.30 ea
1435-1248-96	12Wx48Dx½H	154.50 ea
C732-96	7Wx32Dx½H	86.90 ea

Large Porcelain Square Platter

ITEM	DESCRIPTION	LIST PRICE
PP252	11Wx11Dx1H	\$40.80 ea

3331-96



3332-10-96



3332-7-96



3332-4-96



Cold Concept Cold Pack System

Cold Concept Set

Complete Set Includes: Porcelain Plate, Liner, and Cold Pack. Lid Sold Separately. Place Cold Pack in Freezer for a Minimum of 6 Hours. Keeps Contents Cold for 2-3 Hours.

ITEM	DESCRIPTION	LIST PRICE
3063	Porcelain Plate, Liner, Cold Pack	\$129.20 ea
3402	Hinged Dome Lid	56.70 ea



a Medium Porcelain Square Bowl

ITEM	DESCRIPTION	LIST PRICE
PP251	8Wx8Dx2H	\$27.50 ea

b Porcelain or Melamine Platter

ITEM	DESCRIPTION	LIST PRICE
PP252	11Wx11Dx1H - Porcelain	\$40.80 ea
SR252	11Wx11Wx1H - Melamine	37.50 ea

c Round Porcelain Platter

ITEM	DESCRIPTION	LIST PRICE
PP1167	12¾DIAx1½H	\$38.50 ea

d Small Round Porcelain Bowl

ITEM	DESCRIPTION	LIST PRICE
PP1153	4DIAx2H	\$18.70 ea

e Porcelain and Melamine Platters

ITEM	DESCRIPTION	LIST PRICE
SR152	23Wx7Dx1H - Melamine	\$67.30 ea
PP150	18Wx3Dx1H - Porcelain	51.80 ea
PP152	23Wx7Dx1H - Porcelain	94.90 ea

f Round Melamine Jars

Specify Color: Black (13), White (15).

ITEM	DESCRIPTION	LIST PRICE
1950-16	4DIAx4¼H - 16 oz.	\$18.80 ea
1950-32	5DIAx5½H - 32 oz.	25.30 ea
1950-64	6¾DIAx6¾H - 64 oz.	34.20 ea

g Round Melamine Jars w/ Write-On

Label is Commercial Grade, Scratch and Dent Proof!

ITEM	DESCRIPTION	LIST PRICE
1950-16-15C	4DIAx4¼H - 16 oz.	\$22.50 ea
1950-32-15C	5DIAx5½H - 32 oz.	28.90 ea
1950-64-15C	6¾DIAx6¾H - 64 oz.	38.00 ea

h Square Melamine Jars

ITEM	DESCRIPTION	LIST PRICE
C1432BODY	4Wx4Dx4H Jar Only	\$14.80 ea
1432-15	4Wx4Dx4H Jar w/Full Lid	22.90 ea
1432-15N	4Wx4Dx4H Jar w/Notched Lid	22.90 ea

i Square Melamine Jars w/ Write-On

Label is Commercial Grade, Scratch and Dent Proof!

ITEM	DESCRIPTION	LIST PRICE
C1432BODYC	4Wx4Dx4H Jar Only	\$18.30 ea
1432-15C	4Wx4Dx4H Jar w/Full Lid	26.20 ea
1432-15N-C	4Wx4Dx4H Jar w/Notched Lid	26.20 ea



f White and Black Round Jars

g Round Write On

h Square White Only

i Square Write On

Midnight Bamboo Collection



**Midnight Bamboo
Attendant Serve Case**

Includes 3 — 13" x 18" Black Acrylic Trays.

ITEM	DESCRIPTION	LIST PRICE
284-96	21Wx16½Dx22½H	\$1,040.60 ea
325-13-13	Replacement Tray	42.20 ea



**Midnight Bamboo
Self-Serve Case**

Includes 3 — 13" x 18" Black Acrylic Trays.

ITEM	DESCRIPTION	LIST PRICE
284-S-96	21Wx16½Dx22½H	\$1,040.60 ea
325-13-13	Replacement Tray	42.20 ea



Midnight Bamboo Bread Case

Drawers Made with Green Glass Acrylic.

ITEM	DESCRIPTION	LIST PRICE
813-96	15Wx14Dx15H	\$604.10 ea
813-96DRAWER	Replacement Drawer	58.10 ea



**Midnight Bamboo
Euro Display Case**

Dimensions: 17Wx17Dx18H.

Includes 3 — 10" x 14" Black Acrylic Trays.

ITEM	DESCRIPTION	LIST PRICE
P255-96	Attendant Serve	\$727.30 ea
P255-96S	Self-Serve	857.80 ea
335-10-13	Replacement Tray	39.00 ea

a Midnight Bamboo Cube Riser Set 

Sizes: 9" Square, 7" Square, and 5" Square.
Not Sold Individually.

ITEM	DESCRIPTION	LIST PRICE
1915-96	Set of 3	\$151.90 ea

a



b 3 Shelf Silver Frame Riser 

ITEM	DESCRIPTION	LIST PRICE
1940-96	28Wx12Dx24H	\$375.10 ea

b



c Midnight Bamboo Library Display 

Removable Small Shelf. Cubes Sold Separately.

ITEM	DESCRIPTION	LIST PRICE
1933-96	38Wx12Dx24H	\$573.70 ea

d Midnight Bamboo Cubes 

Sold Individually.

ITEM	DESCRIPTION	LIST PRICE
1929-12-96	12Wx12Dx12H	\$121.30 ea

Cube
Sold
Separately



c



d

visit us online at: www.calmil.com **CAL·MIL** call toll-free 800-321-9069

Midnight Bamboo Collection



Midnight Bamboo Rectangular Crate Risers

These Risers Can Also be Used as Bins and Work with Our Bamboo Shelves (See Page 32).

ITEM	DESCRIPTION	LIST PRICE
1943-3-96	20Wx7Dx3H	\$73.80 ea
1943-7-96	20Wx7Dx7H	119.10 ea
1943-11-96	20Wx7Dx11H	132.40 ea



Midnight Bamboo Square Crate Risers

These Risers Can Also be Used as Bins and Work with Our Bamboo Shelves (See Page 32).

ITEM	DESCRIPTION	LIST PRICE
1944-6-96	6Wx6Dx6H	\$39.80 ea
1944-9-96	9Wx9Dx9H	79.50 ea
1944-12-96	12Wx12Dx12H	132.40 ea
3332-4-96	12Wx12Dx4H	96.40 ea
3332-7-96	12Wx12Dx7H	107.10 ea
3332-10-96	12Wx12Dx10H	139.30 ea



Midnight Bamboo Stair Step Risers

ITEM	DESCRIPTION	LIST PRICE
1934-4-96	20Wx10Dx4H	\$64.00 ea
1934-8-96	22Wx10Dx8H	81.60 ea
1934-12-96	24Wx10Dx12H	108.00 ea



Midnight Bamboo Rectangular Risers

ITEM	DESCRIPTION	LIST PRICE
166-3-96	20Wx7Dx3H	\$73.50 ea
166-7-96	20Wx7Dx7H	119.00 ea
166-11-96	20Wx7Dx11H	131.60 ea



Midnight Bamboo Cube Risers

ITEM	DESCRIPTION	LIST PRICE
432-3-96	12Wx12Dx3H	\$86.00 ea
432-6-96	12Wx12Dx6H	98.40 ea
432-9-96	12Wx12Dx9H	110.50 ea

Midnight Bamboo Beverage Dispensers BPA FREE

1.5 and 3 Gallon Capacity. Includes Drip Tray.

ITEM	DESCRIPTION	LIST PRICE
Ice Chamber		
1527-1-96	8¼Wx10½Dx18H	\$462.70 ea
1527-3-96	8¼Wx10½Dx26H	498.20 ea
Infusion Chamber		
1527-1INF-96	8¼Wx10½Dx18H	\$462.70 ea
1527-3INF-96	8¼Wx10½Dx26H	498.20 ea



Ice Chamber

Infusion Chamber

Midnight Bamboo Crate Beverage Dispenser BPA FREE

3 Gallon Capacity. Includes Drip Tray.

ITEM	DESCRIPTION	LIST PRICE
Ice Chamber		
3301-3-96	8Wx8Dx25½H	\$498.20 ea
Infusion Chamber		
3301-3INF-96	8Wx8Dx25½H	498.20 ea



Midnight Bamboo Flatware/Condiment Display

ITEM	DESCRIPTION	LIST PRICE
1235-13-96	5¼Wx14Dx18H	\$158.60 ea



Midnight Bamboo 9 Bin Tier Display

Includes 9 Bins.

ITEM	DESCRIPTION	LIST PRICE
1817-96	13Wx9½Dx17½D	\$258.00 ea
C4X4-96	Replacement Bin	18.90 ea

Midnight Bamboo Housings

Includes Clear Polycarbonate Pan.

ITEM	DESCRIPTION	LIST PRICE
475-6-96	6Wx7Dx6½H	\$69.20 ea
475-10-96	10Wx12Dx8H	121.80 ea
475-12-96	12Wx20Dx8H	156.90 ea



Midnight Bamboo Cylinder Display

Cylinders Sold Separately.

ITEM	DESCRIPTION	LIST PRICE
1425-3-96	16Wx5½Dx6H	\$35.00 ea
1425-6-96	16Wx11Dx6H	56.10 ea



Midnight Bamboo 3 Tier Cylinder Display

Cylinders Sold Separately. Use for Condiments or Flatware!

ITEM	DESCRIPTION	LIST PRICE
1016-3-96	6¼Wx9½Dx22¾H	\$136.60 ea

Optional Cylinders BPA FREE
Available in Six Colors. Specify Stainless Steel Style: Perforated (39), (Solid). Specify Melamine Color: Black (13), White (15), Butter Yellow (61), Terra Cotta (62), Sage (63), Cranberry (64).

ITEM	DESCRIPTION	LIST PRICE
1017-39	4½DIAx5½H	\$14.80 ea
1017-SOLID	4½DIAx5½H	14.80 ea
1017	4½DIAx5½H	18.80 ea



Midnight Bamboo Collection



Midnight Bamboo Single Airpot Stand with Packet Drawer 

Drip Tray Included. Airpot Not Included.

ITEM	DESCRIPTION	LIST PRICE
1051-1-96	8¼Wx12¾Dx6¼H	\$91.40 ea



Midnight Bamboo Dual Airpot Display 

2 Drip Trays Included.

ITEM	DESCRIPTION	LIST PRICE
360-2-96	7½Wx23½Dx15¼H	\$158.80 ea



Midnight Bamboo Packet Organizers 

ITEM	DESCRIPTION	LIST PRICE
796-96	9Wx6¼Dx4¾H	\$58.20 ea
1246-96	9½Wx4¾Dx2½H	29.60 ea



Midnight Bamboo Napkin or Lid Organizer 

ITEM	DESCRIPTION	LIST PRICE
298-96	4½Wx4½Dx8H	\$39.80 ea



Midnight Bamboo Countertop Trash Bin 

ITEM	DESCRIPTION	LIST PRICE
1717-96	5Wx5Dx7H	\$37.00 ea

a Midnight Bamboo Revolving Cup & Lid Organizer

Holds up to 3.75" Diameter Cups & Lids.

ITEM	DESCRIPTION	LIST PRICE
378-96	8Wx8Dx18½H	\$113.90 ea

b Midnight Bamboo Napkin Holder

ITEM	NAPKIN SIZE	LIST PRICE
1234-96	4Wx8H	\$26.30 ea

c Midnight Bamboo Condiment Station

Pieces Sold Separately.

ITEM	DESCRIPTION	LIST PRICE
2019-96	15Wx14¾Dx9¼H	\$93.70 ea
298-96	4½Wx4½Dx8H - 3 Shown	39.80 ea

d Midnight Bamboo Flatware Display

ITEM	DESCRIPTION	LIST PRICE
1244-96	8¾Wx5½Dx4¾H	\$58.20 ea

e Midnight Bamboo U-Frame Cardholders

ITEM	CARD SIZE	LIST PRICE
1510-32-96	3½Wx2H	\$20.00 ea
1510-46-96	4Wx6H	21.40 ea
1510-811-96	8½Wx11H	34.70 ea

f Midnight Bamboo 3 Step Jar Display

Includes Three Glass Jars.

ITEM	DESCRIPTION	LIST PRICE
1486-96	5Wx14Dx13H	\$149.90 ea
C4X4GLCN	Replacement Jar	19.50 ea



Westport Collection

Inviting mahogany and lasting design results in the stunning Westport Collection.



P255-52S Self-Serve

Westport Euro Display Case

Includes 3 — 10" x 14" Black Trays.

ITEM	DESCRIPTION	LIST PRICE
P255-52	17Wx17Dx18H - Attendant Serve	\$727.30 ea
P255-52S	17Wx17Dx18H - Self-Serve	857.80 ea
335-10-13	Replacement Tray	39.00 ea



Westport Bread Display Case

ITEM	DESCRIPTION	LIST PRICE
813-52	16½Wx15Dx15¾H	\$604.10 ea
813-52DRAWER	Replacement Drawer	58.10 ea



284-52

Westport Display Case

Includes 3 — 13" x 18" Black Acrylic Trays.

ITEM	DESCRIPTION	LIST PRICE
284-52	21¾Wx18½Dx20¼H	\$1,040.60 ea
325-13-13	Replacement Tray	42.20 ea



284-S-52 Self-Serve

Westport Self-Serve Display Case

Includes 3 — 13" x 18" Black Acrylic Trays.

ITEM	DESCRIPTION	LIST PRICE
284-S-52	21¾Wx18½Dx20¼H	\$1,040.60 ea
325-13-13	Replacement Tray	42.20 ea



815-52A

Westport Display Case

Includes 3 — 13" x 18" Black Acrylic Trays.

ITEM	DESCRIPTION	LIST PRICE
815-52A	21Wx16¾Dx18¾H	\$910.60 ea
325-13-13	Replacement Tray	42.20 ea



815-52 Self-Serve

Westport Self-Serve Display Case

Includes 3 — 13" x 18" Black Acrylic Trays.

ITEM	DESCRIPTION	LIST PRICE
815-52	21Wx16¾Dx18¾H	\$910.60 ea
325-13-13	Replacement Tray	42.20 ea



Westport Bread Display

ITEM	DESCRIPTION	LIST PRICE
1204-52	8Wx13Dx21H	\$419.60 ea
1204DRAWER-13	Replacement Drawer	33.40 ea



814-1-52

Westport Display Case

Includes 3 — 10" x 14" Clear Acrylic Trays.

ITEM	DESCRIPTION	LIST PRICE
814-1-52	14Wx17½Dx19¾H	\$594.50 ea
335-10-12	Replacement Tray	32.50 ea



814-52

Westport Display Case

Includes 3 — 10" x 14" Clear Acrylic Trays.

ITEM	DESCRIPTION	LIST PRICE
814-52	17½Wx14Dx19¾H	\$594.50 ea
335-10-12	Replacement Tray	32.50 ea

Westport Collection



Westport Beverage Dispensers BPA FREE

Wood/Acrylic.
1.5 and 3 Gallon Capacity.
Includes Drip Tray.

ITEM	DESCRIPTION	LIST PRICE
Ice Chamber		
1527-1-52	8¼Wx9¾Dx17¾H	\$462.70 ea
1527-3-52	8¼Wx9¾Dx25¾H	498.20 ea
Infusion Chamber		
1527-1INF-52	8¼Wx9¾Dx17¾H	462.70 ea
1527-3INF-52	8¼Wx9¾Dx25¾H	498.20 ea



Westport Beverage Dispensers BPA FREE

2 and 3 Gallon Capacity.
Includes Drip Tray.
Polycarbonate Tank and Base.
Specify Color: Westport (52), Light Wood (53).

ITEM	DESCRIPTION	LIST PRICE
972-2	11Wx11Dx22H	\$591.10 ea
972-3	11Wx11Dx24½H	764.20 ea



Westport Pillar Riser and Shelves

Shelves Sold Separately.

ITEM	DESCRIPTION	LIST PRICE
791-52	9Wx9Dx32½H	\$234.10 ea
Glass Shelves (Sold Separately)		
831-SQ	19¾Wx10Dx¼H	\$52.70 ea
831-RD	19¾Wx10Dx¼H	58.60 ea
C732GLASS	32Wx7Dx¼H	79.90 ea



Westport Drip Trays

ITEM	DESCRIPTION	LIST PRICE
330-4-52	4Wx4Dx1H	\$39.90 ea
330-6-52	6Wx6Dx1H	50.00 ea



Westport Cube Risers

Complete Set of 3 Risers.
Sizes: 9" Square, 7" Square, and 5" Square.

ITEM	DESCRIPTION	LIST PRICE
1915	SET	\$152.10 ea



Westport Butane Stove Frame

Iwatani Model 35FW Not Included.

ITEM	DESCRIPTION	LIST PRICE
1556-52	14Wx14½Dx7½H	\$220.60 ea



Westport Ice Housing

Includes Clear Polycarbonate Pan.

ITEM	DESCRIPTION	LIST PRICE
412-12-52	12Wx20Dx8H	\$379.10 ea
412-18-52	18Wx26Dx8H	524.40 ea

Westport Cut-Mate® High Heat Carving Stations

Specify Color: Westport (52), Light Wood (53).

ITEM	DESCRIPTION	LIST PRICE
810	22Wx18Dx4H	\$587.60 ea



851-WET



852-52

Westport Wet Floor Signs

Two-Sided.

ITEM	DESCRIPTION	LIST PRICE
851-WET	12Wx17½Dx20H	\$276.90 ea
852-52	12Wx17½Dx22H	221.10 ea

visit us online at: www.calmil.com **CAL·MIL** call toll-free 800-321-9069

Mission Collection

Bold, distinct, pillared frames highlight the Mission Collection.



Mission Butane Stove Frame

Iwatani Model 35FW Not Included.

ITEM	DESCRIPTION	LIST PRICE
1363-13	14Wx12Dx7H	\$224.80 ea

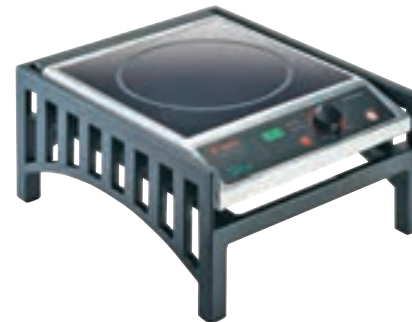

Mission Induction Frame

Induction Unit Not Included. 1414-S Fits Spring SR-261C. 1414-V Fits Volrath 59500.

ITEM	DESCRIPTION	LIST PRICE
1414-S-13	13¾Wx16½D x7H	\$210.70 ea
1414-V-13	14¾Wx16½Dx7H	234.10 ea



Mission Chafer Alternatives

ITEM	DESCRIPTION	LIST PRICE
1360-12-13	12Wx12Dx7½H	\$210.70 ea
1364-12-13	12Wx12Dx5H	210.70 ea
1360-22-13	22Wx12Dx7½H	344.20 ea
1364-22-13	22Wx12Dx4H	344.20 ea



Griddle w/ Heat Guard Handles

Designed to Fit 1360-22-13 and 1364-22-13 Only.

ITEM	DESCRIPTION	LIST PRICE
3067	22¾Wx13¾Dx2¼H	\$123.00 ea



Optional Griddle with Brackets

Designed to Fit 1360-22-13 and 1364-22-13 Only.

ITEM	DESCRIPTION	LIST PRICE
1362	22¾Wx13¾Dx2¼H	\$123.00 ea



Mission Ice Housing

Includes Clear Polycarbonate Pan.

ITEM	DESCRIPTION	LIST PRICE
1365-12-13	22Wx14Dx8½H	\$503.50 ea
1365-18-13	28Wx20Dx8½H	898.80 ea



Mission Chafer

Includes Stainless Steel Chafer Cover.

ITEM	DESCRIPTION	LIST PRICE
1368-13	23Wx14½Dx13½H	\$500.10 ea
3325-55	Replacement Cover	299.90 ea

Mission 2 Tier Jar Display

Includes Glass Jars.

Specify Color: Black (13), Platinum (39).

ITEM	DESCRIPTION	LIST PRICE
1723	14Wx9Dx7H	\$159.80 ea
C4x4GLCN	Replacement Jar	19.50 ea

Optional Jar Lids

Stainless Steel Hinge

1807	4Wx4Dx1½H	\$10.50 ea
1807-N	4Wx4Dx1½H-Notch	10.50 ea

Plastic Hinge

1811	4Wx4Dx1½H	7.30 ea
1811-N	4Wx4Dx1½H-Notch	7.30 ea



1807



1811



Mission Shelf Riser

ITEM	DESCRIPTION	LIST PRICE
1254	24Wx12Dx24H	\$307.40 ea

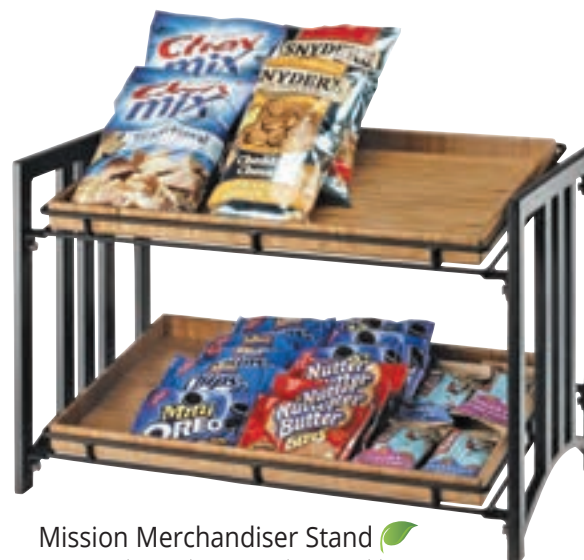

Mission Merchandiser Stand

Frame Only, Bamboo Tray (Shown) Sold Separately. Tray Sizes: 19¾Wx11¾Dx1¼H.

ITEM	DESCRIPTION	LIST PRICE
1722	23Wx13Dx15H	\$270.30 ea

Optional Trays

1367-12-60	Bamboo Tray	\$55.40 ea
1367-12-99	Reclaimed Wood Tray	72.00 ea

visit us online at: www.calmil.com **CAL·MIL** call toll-free 800-321-9069

Mission Collection



Mission Sloped & Vertical Displays

Cylinders Sold Separately.
Specify Frame Color: Black (13), Platinum (39).

ITEM	DESCRIPTION	LIST PRICE
1747-3	7Wx13Dx13H	\$110.50 ea
1746-3	7Wx13Dx10¾H	110.50 ea

Optional Cylinders BPA FREE

Available in Six Colors.
Specify Stainless Steel Color: Perforated (39), (Solid).
Specify Melamine Color: Black (13), White (15),
Butter Yellow (61), Terra Cotta (62), Sage (63),
Cranberry (64).

ITEM	DESCRIPTION	LIST PRICE
1017-39	4½DIAx5½H	\$14.80 ea
1017-SOLID	4½DIAx5½H	14.80 ea
1017	4½DIAx5½H	18.80 ea



Mission Square Bowl Stand

10" Square Melamine Bowls.

ITEM	DESCRIPTION	LIST PRICE
1750-13	12Wx19Dx13½H	\$110.50 ea



Color Selections for Round & Square Bowls

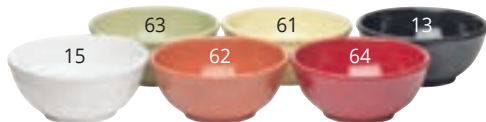

Melamine Round & Square Bowls BPA FREE

Specify Color: Black (13), White (15), Butter Yellow (61),
Terra Cotta (62), Sage (63), Cranberry (64).

ITEM	DESCRIPTION	LIST PRICE
418-8	8" Round Bowl	\$33.00 ea
418-10	10" Round Bowl	55.70 ea
1707-10	10" Square Bowl	77.60 ea

Mission Round Bowl Stand

8" and 10" Bowls Sold Separately.

ITEM	DESCRIPTION	LIST PRICE
1712-8-13	10½Wx15½Dx15½H - 8" Bowls	\$83.50 ea
1712-10-13	12Wx19Dx17½H - 10" Bowls	98.40 ea



Enamelware Melamine Bowls

ITEM	DESCRIPTION	LIST PRICE
3343-8-15	8¼DIAx3¾H	\$33.00 ea
3343-10-15	10¾DIAx5H	55.70 ea



a Mission Toast Bar  *New*
Includes 6 White Melamine Jars, 1 Maple Cutting Board, and 1 Slate Insert.

ITEM	DESCRIPTION	LIST PRICE
3455	28½Wx12½Dx9¾H	\$350.00 ea



b Mission Square Dispensers  *BPA FREE*
1.5 and 3 Gallon Capacity.
Powder Coated Metal Base.

ITEM	DESCRIPTION	LIST PRICE
1112-1-13	7Wx9Dx19H	\$462.70 ea
1112-3-13	7Wx9Dx26½H - Glass	498.20 ea
1112-1A-13	7Wx9Dx19H - Acrylic	462.70 ea
1112-3A-13	7Wx9Dx26½H - Acrylic	498.20 ea



c Mission Dual Airpot Stand 
Airpots Not Included.

ITEM	DESCRIPTION	LIST PRICE
1704-13	8Wx22Dx15H	\$155.10 ea



d Mission Wire Merchandiser 
Specify Color: Black (13), Platinum (39).

ITEM	DESCRIPTION	LIST PRICE
1702	13½Wx15Dx16½H	\$186.50 ea



e Mission Condiment Organizer 
Holds up to 4" Diameter Cups & Lids.
Specify Color: Black (13), Platinum (39).

ITEM	DESCRIPTION	LIST PRICE
1715	15Wx14Dx12H	\$110.50 ea

Luxe Collection

Accented in stainless steel, the Luxe Collection exemplifies true elegance and luxury.



Luxe Chafer

Includes Stainless Steel Chafer Cover.
Stainless Steel Trim (55).

ITEM	DESCRIPTION	LIST PRICE
3017-55	23Wx14½Dx13½H	\$500.10 ea
3325-55	Replacement Cover	299.90 ea



Luxe Butane Burner Housing

Iwatani Model 35FW Not Included.
Stainless Steel Trim (55).

ITEM	DESCRIPTION	LIST PRICE
3023-55	12Wx14¼Dx7½H	\$227.30 ea



Luxe Chafer Alternative

Includes Wire Grill and Fuel Cell Rail with Windguard.
Stainless Steel Trim (55).

ITEM	DESCRIPTION	LIST PRICE
3011-55	12Wx12Dx8¾H	\$204.60 ea
3012-55	22Wx12Dx8¾H	284.10 ea

a Luxe Three Bowl Display

Includes Three White 8" Melamine Square Bowls.
Stainless Steel Trim (55).

ITEM	DESCRIPTION	LIST PRICE
3022-55	10Wx16¼Dx17H	\$278.50 ea
SR261	Replacement Bowl	32.10 ea



b Luxe Multi Level 4 Bowl Display

Includes 4 Melamine Bowls.
Stainless Steel Trim (55).

ITEM	DESCRIPTION	LIST PRICE
3024-55	20WX16DX13½H	\$455.30 ea
SR261	Replacement Bowl	32.10 ea



c Luxe Two Step Ice Housing Display

Includes 2 White Melamine 1/6 Housings.
Stainless Steel Trim (55).

ITEM	DESCRIPTION	LIST PRICE
3004-55	7Wx12¾Dx8H	\$203.50 ea
475-6-15	Replacement Ice Housing	69.20 ea

d Luxe Nine Jar Condiment Display

Jars Included. Dimensions: 12¼Wx9Dx15½H
Stainless Steel Trim (55).

ITEM	DESCRIPTION	LIST PRICE
3018-55-12	Stand w/ 9 Glass Jars	\$299.90 ea
3018-55-15	Stand w/ 9 White Melamine Jars	321.40 ea

Replacement Jars

C4X4GLCN	Glass Jars	\$19.50 ea
C1432BODY	White Melamine Jars	14.80 ea



Luxe Collection



Luxe Stair Step Jar Display

Specify Jar, Stainless Steel Trim (55).

ITEM	DESCRIPTION	LIST PRICE
3003-55-12	Stand w/ 3 Glass Jars 4½Wx13Dx9H	\$125.00 ea
3003-55-15	Stand w/ 3 White Melamine Jars 4½Wx13Dx9H	133.90 ea

Replacement Jars

C4X4GLCN	Glass Jars	\$19.50 ea
C1432BODY	White Melamine Jars	14.80 ea



Luxe Vertical Cylinder Display

Cylinders Sold Separately. Stainless Steel Trim (55).

ITEM	DESCRIPTION	LIST PRICE
3010-55	6¾Wx7½Dx20¼H	\$159.00 ea

Optional Cylinders BPA FREE

Available in Six Colors.

Specify Stainless Steel Style: Perforated (39), (Solid).
Specify Melamine Color: Black (13), White (15), Butter Yellow (61), Terra Cotta (62), Sage (63), Cranberry (64).

ITEM	DESCRIPTION	LIST PRICE
1017-39	4½DIAx5½H	\$14.80 ea
1017-SOLID	4½DIAx5½H	14.80 ea
1017	4½DIAx5½H	18.80 ea



Luxe Rectangular Risers

Stainless Steel Trim (55).

ITEM	DESCRIPTION	LIST PRICE
3025-55	12Wx20Dx6½H	\$359.90 ea
3026-55	12Wx10Dx6½H	325.70 ea



Luxe Three Section Cereal Dispenser

Stainless Steel Trim (55).

ITEM	DESCRIPTION	LIST PRICE
3019-55	17½Wx13½Dx24H	\$1,156.50 ea



Luxe Three Step Bread Case Display

Includes 3 — 13x18 White Trays.
Stainless Steel Trim (55).

ITEM	DESCRIPTION	LIST PRICE
3020-55	19Wx20Dx19H	\$576.20 ea
325-13-15	Replacement Tray	42.20 ea



Luxe Signage and Menu Holders

Stainless Steel Trim (55).

ITEM	CARD SIZE	LIST PRICE
3016-811-55	8Wx11H	\$48.00 ea



Luxe Multi-Section Condiment Organizer

Stainless Steel Trim (55).

ITEM	DESCRIPTION	LIST PRICE
3009-55	12¼Wx12¼Dx6½H	\$174.50 ea



Luxe Three Compartment Condiment Organizer

Stainless Steel Trim (55).

ITEM	DESCRIPTION	LIST PRICE
3014-55	9¼Wx4½Dx2½H	\$79.10 ea



Luxe Flatware Organizer

Stainless Steel Trim (55).

ITEM	DESCRIPTION	LIST PRICE
3015-55	8¼Wx5¾Dx6H	\$107.50 ea

visit us online at: www.calmil.com **CAL·MIL** call toll-free 800-321-9069

Luxe Collection



Ice Chamber



Infusion Chamber

Luxe Acrylic Beverage Dispenser

3 Gallon Capacity. Includes Drip Tray. Stainless Steel Trim (55).

ITEM	DESCRIPTION	LIST PRICE
Ice Chamber		
3002-3-55	7¾Wx7¾Dx25¾H	\$498.20 ea
Infusion Chamber		
3002-3INF-55	7¾Wx7¾Dx25¾H	498.20 ea



Luxe Ice Housings

Includes Clear Polycarbonate Bin. Stainless Steel Trim (55).

ITEM	DESCRIPTION	LIST PRICE
3005-10-55	10Wx12¼Dx6½H	\$416.80 ea
3005-12-55	12¼Wx20¼Dx6¼H	460.70 ea

Luxe Revolving Cup/Lid Organizer

Holds Cups and Lids up to 3.75" Diameter. Stainless Steel Trim (55).

ITEM	DESCRIPTION	LIST PRICE
3001-55	8¼Wx8¼Dx19H	\$159.00 ea





Luxe Three Tier Bread Display
Includes 3 White Trays.
Stainless Steel Trim (55).

ITEM	DESCRIPTION	LIST PRICE
3021-55	7Wx14Dx20¼H	\$296.80 ea



Luxe Two Step Airpot Stand

Drip Trays Included.
Stainless Steel Trim (55).

ITEM	DESCRIPTION	LIST PRICE
3008-55	7Wx22½Dx12½H	\$257.10 ea



Luxe Tabletop Trash Bin *New*

Constructed of Bamboo and Stainless Steel.

ITEM	DESCRIPTION	LIST PRICE
1717-15	5Wx5Dx7H	\$37.00 ea



Luxe Chilled Mixology Stands *New*

Complete Set Includes Base, 3 Jars with Cold Pucks.
Stainless Steel Trim (55). Specify Lid Type.

ITEM	DESCRIPTION	LIST PRICE
3492-4-15	16Wx6Dx4H - w/ Solid Lids	\$144.60 ea
3492-4-15HL	16Wx6Dx4H - w/ Hinged Lids	176.70 ea
3492-4-15NL	16Wx6Dx4H - w/ Notched Lids	176.70 ea



Round Base Flip Lid Chill Sampler

Includes Plate, Flip Lid, Cold Packs and Liner to Keep Contents Cold.
Stainless Steel Trim (55).

ITEM	DESCRIPTION	LIST PRICE
3328-12-55	12DIAx7½H	\$230.40 ea
CC3328	Replacement Packs & Liner	87.80 ea



Square Stainless Steel Cold Sampler

Includes Plate, Flip Lid, Cold Packs and Liner to Keep Contents Cold.
Stainless Steel Trim (55).

ITEM	DESCRIPTION	LIST PRICE
3329-12-55	12Wx13Dx7½H	\$230.40 ea
CC3329	Replacement Packs & Liner	87.80 ea

visit us online at: www.calmil.com **CAL·MIL** call toll-free 800-321-9069

Squared Collection

State-of-the-art metalwork creates a contemporary expression with the Squared Collection.



Squared Acrylic Beverage Dispensers

1.5 and 3 Gallon Capacities. Includes Drip Tray.
Specify Color: Black (13), Stainless Steel (55).

ITEM	DESCRIPTION	LIST PRICE
Ice Chamber		
1602-1	7½Wx9½Dx17¾H	\$462.70 ea
1602-3	7½Wx9½Dx25¾H	498.20 ea
Infusion Chamber		
1602-1INF	7½Wx9½Dx17¾H	\$462.70 ea
1602-3INF	7½Wx9½Dx25¾H	498.20 ea



Squared Revolving Cup and Lid Dispenser

Hold Cups and Lids Up to 3.75" in Diameter.
Black (13), Stainless Steel (55).

ITEM	DESCRIPTION	LIST PRICE
1615-13	8¾Wx8¾Dx18¾H	\$159.00 ea
1615-55	8¾Wx8¾Dx18¾H	204.60 ea

a Squared Chafer

Includes Stainless Steel Chafer Cover.
Black (13), Stainless Steel (55).

ITEM	DESCRIPTION	LIST PRICE
1613-13	23Wx14½Dx13½H	\$500.10 ea
1613-55	23Wx14½Dx13½H	613.70 ea
3325-55	Replacement Cover	299.90 ea



b Squared Ice Housing

Includes Clear Polycarbonate Bin.
Black (13), Stainless Steel (55).

ITEM	DESCRIPTION	LIST PRICE
1603-12-13	21Wx12½Dx6½H	\$488.80 ea
1603-12-55	21Wx12½Dx6½H	570.20 ea



c Squared Napkin Holder

Black (13), Stainless Steel (55).

ITEM	NAPKIN SIZE	LIST PRICE
1606-13	4Wx8H	\$62.50 ea
1606-55	4Wx8H	68.10 ea



d Squared Self-Serve Display Cases

Includes 3 Clear Trays.
Black (13), Stainless Steel (55).

ITEM	DESCRIPTION	LIST PRICE
1621-13	15¼WX13DX17¼H - 10x14 Trays	\$508.40 ea
1621-55	15¼WX13DX17¼H - 10x14 Trays	558.30 ea
1623-13	20¼WX19¼DX15H - 13x18 Trays	576.20 ea
1623-55	20¼WX19¼DX15H - 13x18 Trays	633.50 ea

Replacement Trays

335-10-12	Replacement 10x14 Tray	\$32.50 ea
325-13-12	Replacement 13x18 Tray	36.50 ea

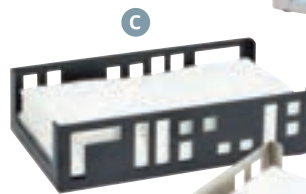

e Squared Acrylic Bread Case

Black (13), Stainless Steel (55).

ITEM	DESCRIPTION	LIST PRICE
1614-13	7Wx12Dx20H	\$296.80 ea
1614-55	7Wx12Dx20H	337.50 ea
1204DRAWER	Replacement Drawer	30.80 ea



Squared Collection



Squared Condiment Organizer

Black (13), Stainless Steel (55).

ITEM	DESCRIPTION	LIST PRICE
1616-13	12Wx12Dx5¼H	\$170.50 ea
1616-55	12Wx12Dx5¼H	204.60 ea



Squared 3 Step Jar Display

Includes 3 Glass Jars.
Black (13), Stainless Steel (55).

ITEM	DESCRIPTION	LIST PRICE
1604-13	4Wx12Dx10½H	\$125.00 ea
1604-55	4Wx12Dx10½H	159.00 ea
C4X4GLCN	Replacement Jar	19.50 ea



Squared Packet Organizer

Black (13), Stainless Steel (55).

ITEM	DESCRIPTION	LIST PRICE
1611-13	9½Wx4½Dx2H	\$77.30 ea
1611-55	9½Wx4½Dx2H	91.00 ea

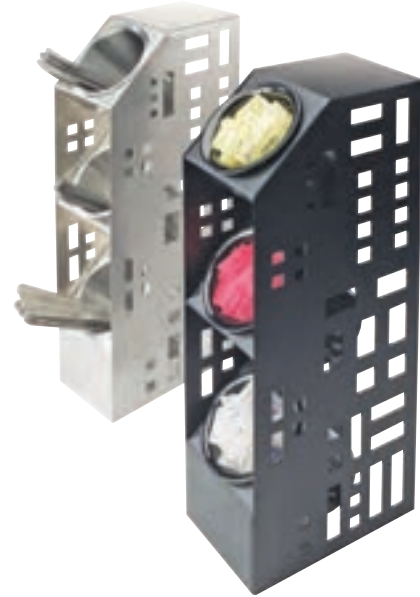

Squared 3 Cylinder Display

Cylinders Sold Separately.
Black (13), Stainless Steel (55).

ITEM	DESCRIPTION	LIST PRICE
1605-13	5Wx8Dx20½H	\$159.00 ea
1605-55	5Wx8Dx20½H	204.60 ea

Solid



Optional Cylinders BPA FREE

Specify Stainless Steel Color: Perforated (39), (Solid).
Specify Melamine Color: Black (13), White (15), Butter Yellow (61), Terra Cotta (62), Sage (63), Cranberry (64).

ITEM	DESCRIPTION	LIST PRICE
1017-39	4½DIAx5½H	\$14.80 ea
1017-SOLID	4½DIAx5½H	14.80 ea
1017	4½DIAx5½H	18.80 ea



Squared Cylinder Display

Cylinders Sold Separately.
Use for Condiments or Flatware!
Black (13), Stainless Steel (55).

ITEM	DESCRIPTION	LIST PRICE
1608-13	16Wx5¼Dx6H	\$86.30 ea
1608-55	16Wx5¼Dx6H	99.90 ea

a Squared Butane Stove Frame

Iwatani Model 35FW Not Included.
Black (13), Stainless Steel (55).

ITEM	DESCRIPTION	LIST PRICE
1617-13	13Wx11Dx6H	\$227.30 ea
1617-55	13Wx11Dx6H	272.70 ea



b Squared Chafer Alternative

Has Built In Windguards.
Black (13), Stainless Steel (55).

ITEM	DESCRIPTION	LIST PRICE
1612-12-13	12Wx12Dx7½H	\$204.60 ea
1612-12-55	12Wx12Dx7½H	272.70 ea
1612-22-13	23Wx15Dx11H	284.10 ea
1612-22-55	23Wx15Dx11H	329.60 ea



c Optional Griddle with Brackets

Fits 1612-22-13 and 1612-22-55.

ITEM	DESCRIPTION	LIST PRICE
1362	22¾Wx13¾Dx2¼H	\$123.00 ea



d Tempered Glass Shelves

For More Shelf Options, See Page 129.

ITEM	DESCRIPTION	LIST PRICE
1431-16	16Wx16Dx¼H - L Shape	\$108.80 ea
1431-24	24Wx24Dx¼H - L Shape	152.10 ea
1435-1212	12Wx12Dx¼H - Square	44.50 ea
1435-1616	16Wx16D - Square	58.60 ea
1435-2424	24Wx24D - Square	93.60 ea
1435-1624	24Wx16D - Rectangle	70.30 ea
1443-12	12" Diameter - Round	58.50 ea
1443-16	16" Diameter - Round	93.60 ea
1443-24	24" Diameter - Round	140.40 ea
1444-16	16Wx16D - Curved	105.40 ea
1444-24	24Wx24D - Curved	152.10 ea

e Squared Cube Risers

Glass Tops Sold Separately.
Black (13), Stainless Steel (55).

ITEM	DESCRIPTION	LIST PRICE
1607-5-13	5Wx5Dx5H	\$68.10 ea
1607-5-55	5Wx5Dx5H	79.60 ea
1607-7-13	7Wx7Dx7H	96.60 ea
1607-7-55	7Wx7Dx7H	113.60 ea
1607-9-13	9Wx9Dx9H	147.70 ea
1607-9-55	9Wx9Dx9H	170.50 ea



visit us online at: www.calmil.com **CAL·MIL** call toll-free 800-321-9069

Glacier Collection

The Glacier Collection joins soft, faux glass with platinum and black accents for top-of-the-line presentation.



Glacier Stair-Step Riser

ITEM	DESCRIPTION	LIST PRICE
1463	11½Wx20Dx7H	\$132.10 ea

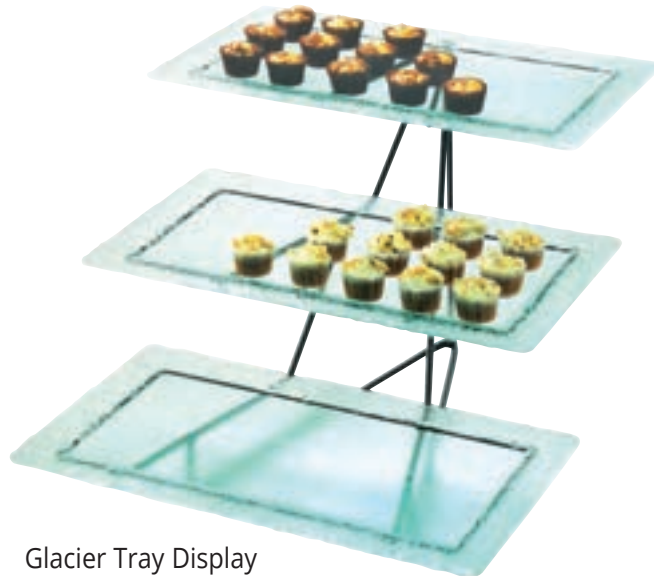

Glacier Tray Display

Includes Removable Faux Glass Trays.

ITEM	DESCRIPTION	LIST PRICE
1710-13	24¾Wx20¾Dx15¼H	\$416.20 ea
1245-12-43	Replacement Tray	88.20 ea



Glacier Oval Metal Stand

Includes 2 Faux Glass Bowls with Trays.
Specify Color: Black (13), Platinum (39).

ITEM	DESCRIPTION	LIST PRICE
GL2400	20Wx20Dx14H	\$702.00 ea
GL2450-43	Replacement Bowl & Tray	241.30 ea





Glacier Condiment/Flatware Display

Specify Color: Black (13), Platinum (39).

ITEM	DESCRIPTION	LIST PRICE
1235-13-43	5¼Wx14Dx18H	\$189.30 ea
1235-39-43	5¼Wx14Dx18H	189.30 ea
C1235INSERT	Replacement Bin	33.10 ea



Glacier Tea Center Display

ITEM	DESCRIPTION	LIST PRICE
1235-TEA	7½Wx14½Dx18H	\$222.10 ea



Glacier Square Step-Up Riser

Includes 3 Faux Glass Platters.

Specify Color: Black (13), Platinum (39).

ITEM	DESCRIPTION	LIST PRICE
GL1600	31½Wx14Dx9H	\$351.00 ea
GL252-43	Replacement Tray	54.90 ea



Glacier Acrylic Display Case

Includes 3 — 10" x 14" Clear Trays.

Self Serve or Attendant Serve.

ITEM	DESCRIPTION	LIST PRICE
1501-13	16Wx12Dx19H	\$594.50 ea
335-10-12	Replacement Tray	32.50 ea



Glacier Straw & Stir Stick Holder

ITEM	DESCRIPTION	LIST PRICE
1228	3½Wx3½Dx3½H	\$35.40 ea
1228-4	4¾Wx4¾Dx5½H	43.30 ea



Glacier Flatware Holder

ITEM	DESCRIPTION	LIST PRICE
H350-13	6Wx6Dx6H	\$119.10 ea



Glacier Napkin Holder

ITEM	NAPKIN SIZE	LIST PRICE
1242	8Wx8D	\$83.30 ea

visit us online at: www.calmil.com **CAL·MIL** call toll-free 800-321-9069

Glacier Collection



Glacier Ice Housing

Metal/Acrylic. Includes Polycarbonate Pan. 413-24-13 has a Drain.

ITEM	DESCRIPTION	LIST PRICE
413-12-13	12Wx20Dx8H	\$527.50 ea
413-18-13	18Wx26Dx8H	898.80 ea
413-24-13*	24Wx48Dx8H	1,850.10 ea

*Ships by Truck Only



Glacier Riser

Closed on Bottom.

ITEM	DESCRIPTION	LIST PRICE
432-8-43	8Wx8Dx8H	\$88.20 ea
432-13-43	13Wx8Dx6H	117.40 ea



Glacier Beverage Dispensers *New*

3 Gallon Capacity. Specify Color: Clear Faux Glass (12), Green Faux Glass (43).

ITEM	DESCRIPTION	LIST PRICE
Ice Chamber		
3437-3	7Wx9Dx26½H	\$486.60 ea
Infusion Chamber		
3437-3INF	7Wx9Dx26½H	486.60 ea

Glacier Acrylic Beverage Dispensers

2 and 3 Gallon Capacities. Includes Drip Tray.

ITEM	DESCRIPTION	LIST PRICE
Ice Chamber		
932-2	10Wx10Dx20H	\$591.10 ea
932-3	11Wx11Dx22H	764.20 ea
Infusion Chamber		
932-2INF	10Wx10Dx20H	\$591.10 ea
932-3INF	11Wx11Dx22H	764.20 ea



Ice Chamber



Infusion Chamber



Glacier Iced Oval Bowl with Tray

ITEM	DESCRIPTION	LIST PRICE
GL2450-43	14Wx19Dx3H	\$241.30 ea



Glacier Serpentine Tray

ITEM	DESCRIPTION	LIST PRICE
GL352-43	17Wx17Dx2H	\$153.60 ea

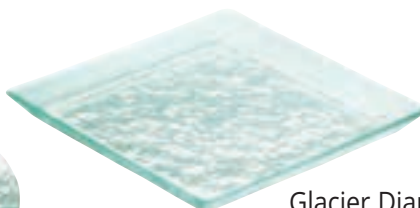

Glacier Diamond Platter

ITEM	DESCRIPTION	LIST PRICE
GL252-43	10½Wx10½Dx1H	\$54.90 ea

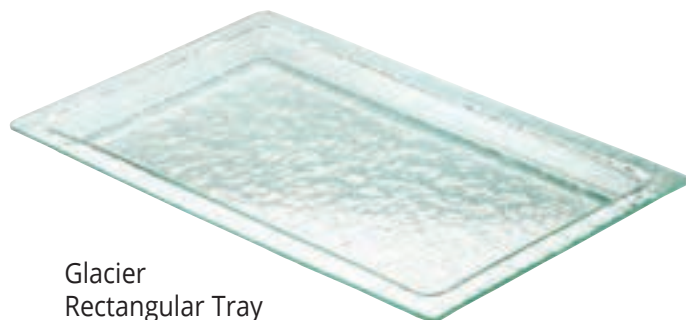

Glacier Rectangular Tray

ITEM	DESCRIPTION	LIST PRICE
GL111-43	13Wx21Dx1H	\$131.60 ea



Glacier Rolled Edge Oval Tray

ITEM	DESCRIPTION	LIST PRICE
GE242-43	12Wx24Dx1H	\$131.60 ea

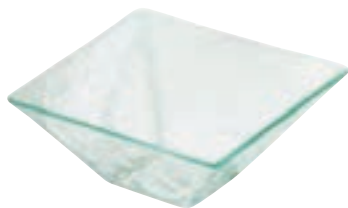

Glacier Diamond Bowl

ITEM	DESCRIPTION	LIST PRICE
GL250-43	7Wx7Dx3H	\$41.70 ea



Glacier Bow Tie Tray

ITEM	DESCRIPTION	LIST PRICE
GL353-43	14Wx28Dx1H	\$153.60 ea

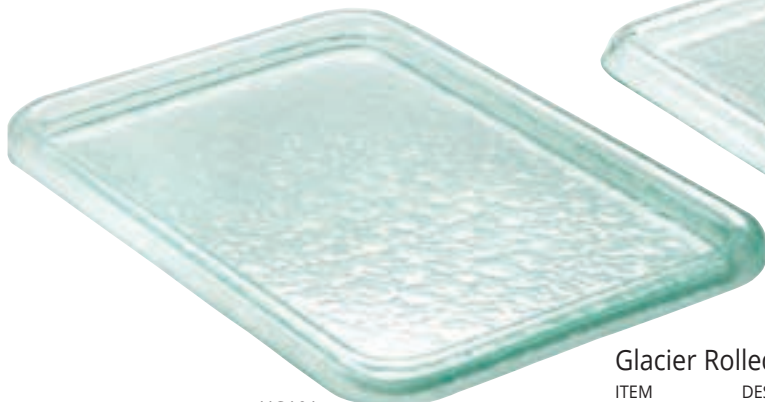

UG101



GE243

Glacier Rolled Edge Rectangular Platters

ITEM	DESCRIPTION	LIST PRICE
UG101-43	17Wx25Dx1H	\$153.60 ea
GE243-43	12Wx24Dx1H	131.60 ea

visit us online at: www.calmil.com **CAL·MIL** call toll-free 800-321-9069

Soho Collection

Using beautifully crafted ribbon styled wire, the Soho Collection offers an upscale, trendy line of products.



Soho Ice Housings

Includes Clear Polycarbonate Ice Pan. Frost (33), Faux Glass (43).

ITEM	DESCRIPTION	LIST PRICE
Black Frame		
1581-12-33	20¾Wx14¾Dx8H	\$488.80 ea
1581-12-43	20¾Wx14¾Dx8H	488.80 ea
Silver Frame		
1582-12-33	20¾Wx14¾Dx8H	\$488.80 ea
1582-12-43	20¾Wx14¾Dx8H	488.80 ea



Ice Chamber



Infusion Chamber

Soho Round Glass Beverage Dispensers ^{BPA FREE}

2 and 3 Gallon Capacity. Includes Drip Tray. Specify Color: Black (13), Silver (74).

ITEM	DESCRIPTION	LIST PRICE
Ice Chamber		
1580-2	10Wx12Dx20½H	\$462.70 ea
1580-3	10Wx12Dx24½H	498.20 ea
Infusion Chamber		
1580-2INF	10Wx12Dx20½H	\$462.70 ea
1580-3INF	10Wx12Dx24½H	498.20 ea



Soho Condiment Organizer

Holds up to 3.75" Diameter Cups & Lids.
Includes Acrylic Insert for Stir Sticks & Packets.
Specify Color: Black (13), Silver (74).

ITEM	DESCRIPTION	LIST PRICE
1594	15¾Wx11¾Dx12H	\$110.50 ea



Soho Napkin Holder

Holds 4" x 8" Napkins.
Frost (33), Faux (43).

ITEM	DESCRIPTION	LIST PRICE
Black Frame		
1588-33	9½Wx6¼Dx3½H	\$69.80 ea
1588-43	9½Wx6¼Dx3½H	69.80 ea
Silver Frame		
1595-33	9½Wx6¼Dx 3½H	69.80 ea
1595-43	9½Wx6¼Dx3½H	69.80 ea



Soho Flatware Display

Specify Color: Black (13), Silver (74).

ITEM	DESCRIPTION	LIST PRICE
1544	4Wx4Dx4½H	\$45.40 ea

Soho 3 Tier Cylinder Display

Cylinders Sold Separately.
Specify Color: Black (13), Silver (74).

ITEM	DESCRIPTION	LIST PRICE
1583	8¾Wx8½Dx21H	\$113.60 ea

Optional Cylinders

Specify Stainless Steel Color:
Perforated (39), (Solid).
Specify Melamine Color: Black (13), White (15), Butter Yellow (61), Terra Cotta (62), Sage (63), Cranberry (64).

ITEM	DESCRIPTION	LIST PRICE
1017-39	4½DIAx5½H	\$14.80 ea
1017-Solid	4½DIAx5½H	14.80 ea
1017	4½DIAx5½H	18.80 ea



visit us online at: www.calmil.com **CAL·MIL** call toll-free 800-321-9069

Soho Collection



Soho Display Case - Self-Serve

Includes 3 Acrylic Black Trays and Silver Includes Acrylic Clear Trays.
Specify Color: Black (13), Silver (74).

ITEM	DESCRIPTION	LIST PRICE
1574-S	17¼Wx12¾Dx20¾H - 10x14 Trays	\$508.40 ea
1575-S	21¼Wx15¾Dx20¾H - 13x18 Trays	576.20 ea



Soho Display Case - Attendant Serve

Includes 3 Acrylic Black Trays and Silver Includes Acrylic Clear Trays.
Specify Color: Black (13), Silver (74).

ITEM	DESCRIPTION	LIST PRICE
1574	17¼Wx12¾Dx20¾H - 10x14 Trays	\$508.40 ea
1575	21¼Wx15¾Dx20¾H - 13x18 Trays	576.20 ea

Replacement Trays

Clear (12), Black (13).

335-10-12	Replacement 10x14 Tray	\$32.50 ea
335-10-13	Replacement 10x14 Tray	39.00 ea
325-13-12	Replacement 13x18 Tray	36.50 ea
325-13-13	Replacement 13x18 Tray	42.20 ea



Soho 2 Tier Merchandiser Frame

Frame Only, Baskets Sold Separately.
Specify Color: Black (13), Silver (74).

ITEM	DESCRIPTION	LIST PRICE
1584-12	23¾Wx14¼Dx26½H - Frame	\$227.30 ea
1593-12	12Wx12D - Wire Basket	51.20 ea





Soho Bread Case

Specify Color: Black (13), Silver (74).

ITEM	DESCRIPTION	LIST PRICE
1586	14Wx13Dx14½H	\$290.90 ea

Replacement Drawers

1586-13DRAWER	Drawer w/ Black Knob	\$71.50 ea
1586-74DRAWER	Drawer w/ Silver Knob	71.50 ea

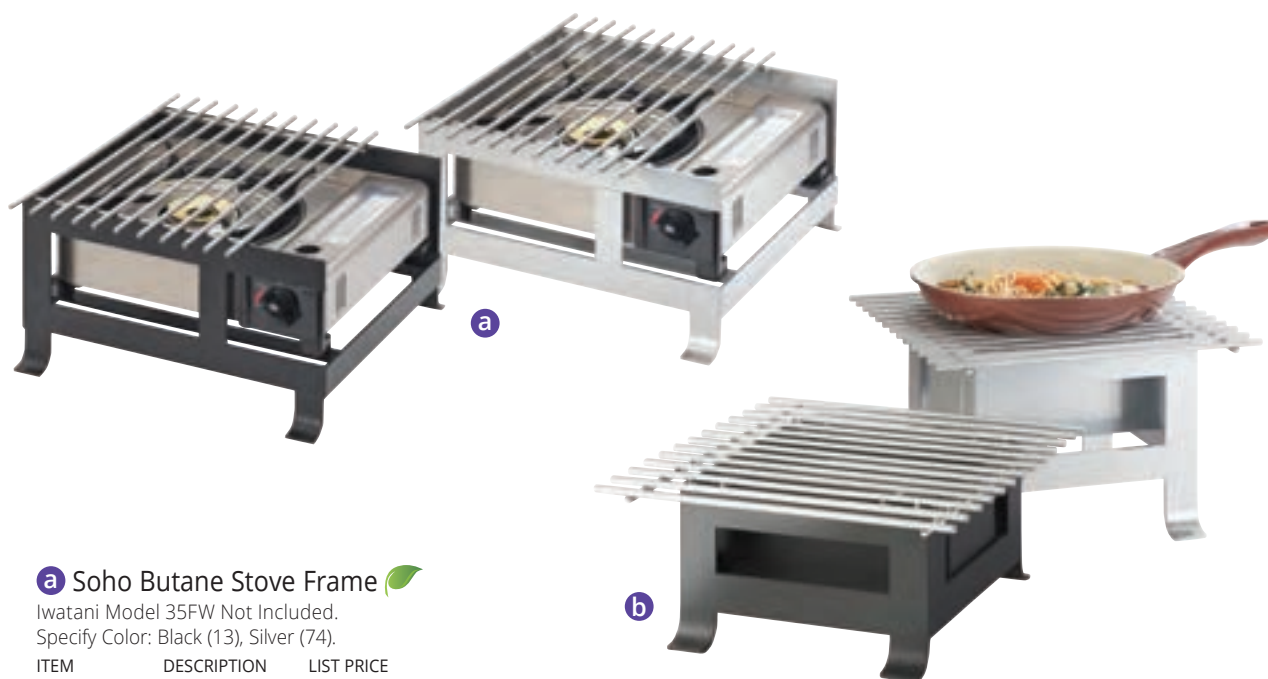

a Soho Butane Stove Frame

Iwatani Model 35FW Not Included.
Specify Color: Black (13), Silver (74).

ITEM	DESCRIPTION	LIST PRICE
1576	14Wx13¾Dx7¼H	\$176.50 ea

b Soho 12x12 Chafer Alternative

Specify Color: Black (13), Silver (74).

ITEM	DESCRIPTION	LIST PRICE
3365-12	12Wx12Dx5H	\$196.70 ea
3403-12	12Wx12Dx7½H	201.90 ea

c Soho 12x22 Chafer Alternative

Specify Color: Black (13), Silver (74).

ITEM	DESCRIPTION	LIST PRICE
3365-22	22Wx12Dx5H	\$309.00 ea

visit us online at: www.calmil.com **CAL·MIL** call toll-free 800-321-9069

One By One Collection

Offered in black and silver, the One By One Collection presents the perfect balance between industrial and elegant.



One by One Tiered Riser

Shelf Inserts Sold Separately.
Specify Color Frame: Black (13), Silver (74).

ITEM	DESCRIPTION	LIST PRICE
1140	32¼Wx13Dx10½H	\$176.50 ea

Optional Shelves

White Corian (15), Bamboo (60).

ITEM	DESCRIPTION	LIST PRICE
1128-1212-15	12Wx12Dx¼H	\$39.40 ea
1128-1212-60	12Wx12Dx¼H	38.50 ea



One By One Multi Level Shelf Display

Shelves Are Removable For Cleaning.
Specify Shelf Color: Bamboo (60),
Midnight Bamboo (96).

ITEM	DESCRIPTION	LIST PRICE
3303	28½Wx13½Dx36½H - Black Stand	\$642.70 ea
3304	28½Wx13½Dx36½H - Silver Stand	642.70 ea



One by One 3 Shelf Metal Frame Riser

Midnight Bamboo (96).

ITEM	DESCRIPTION	LIST PRICE
1940-96	28Wx12Dx24H	\$375.10 ea



Ice Chamber



Chamber Lock

a



Infusion Chamber



Infusion Chamber

b



Ice Chamber

a One by One Acrylic Beverage Dispenser w/Handles

Available in 3 Gallon Capacity Only. Includes Drip Tray and Clear Insert to Secure Lids. Specify Color: Black (13), Silver (74).

ITEM	DESCRIPTION	LIST PRICE
Ice Chamber		
3302-3	9Wx9DX28½H	\$597.60 ea
Infusion Chamber		
3302-3INF	9Wx9DX28½H	597.60 ea

b One by One Acrylic Beverage Dispensers

1.5, 3, and 5 Gallon Capacities. Includes Drip Tray. Specify Color: Black (13), Silver (74).

ITEM	DESCRIPTION	LIST PRICE
Ice Chamber		
1132-1	10¼Wx10½Dx17¾H	\$462.70 ea
1132-3	10¼Wx10½Dx25½H	498.00 ea
1132-5	11¾Wx11¾Dx29H	685.60 ea
Infusion Chamber		
1132-1INF	10¼Wx10½Dx17¾H	462.70 ea
1132-3INF	10¼Wx10½Dx25½H	498.00 ea
1132-5INF	11¾Wx11¾Dx29H	685.60 ea

c



c One by One Condiment Organizer

Insert is Removable for Cleaning. Specify Color: Black (13), Silver (74).

ITEM	DESCRIPTION	LIST PRICE
1148	13Wx14Dx6½H	\$155.80 ea

d One by One Glass Jar Display

Includes 3 Glass Jars. Specify Color: Black (13), Silver (74).

ITEM	DESCRIPTION	LIST PRICE
1149	6¼Wx13¼Dx11½H	\$115.80 ea
C4X4GLCN	Replacement Jar	19.50 ea



d

e One by One 8½x11 Metal Magnetic Sign Displays

Features a Metal Sign with Magnetic Front for Secure Display. Holds 8½x11 Card Size. Specify Color: Black (13), Silver (74).

ITEM	DESCRIPTION	LIST PRICE
1153-46	8½Wx11Dx46H	\$158.20 ea
1153-15	8½Wx7Dx15H	90.40 ea



e

1153-46



e

1153-15

visit us online at: www.calmil.com **CAL·MIL** call toll-free 800-321-9069

One By One Collection



One by One 4 Drawer Acrylic Bread Case

Specify Color: Black (13), Silver (74).

ITEM	DESCRIPTION	LIST PRICE
1146	14Wx14½Dx15¾H	\$291.50 ea

One by One 3 Tier Acrylic Bread Case

Specify Color: Black (13), Silver (74).

ITEM	DESCRIPTION	LIST PRICE
1155	9½Wx14¼Dx19¾H	\$248.50 ea



One by One Display Cases

Available in Self Serve and Attendant Serve.

Specify Color: Black (13), Silver (74).

ITEM	DESCRIPTION	LIST PRICE
1143	14Wx10Dx22H - 10x14 Trays	\$508.40 ea
1143-S	14Wx10Dx22H - 10x14 Trays	508.40 ea
1145	18Wx13Dx22H - 13x18 Trays	576.20 ea
1145-S	18Wx13Dx22H - 13x18 Trays	576.20 ea

Replacement Trays

Clear (12), Black (13).

335-10-12	Replacement 10x14 Tray	\$32.50 ea
335-10-13	Replacement 10x14 Tray	39.00 ea
325-13-12	Replacement 13x18 Tray	36.50 ea
325-13-13	Replacement 13x18 Tray	42.20 ea



One by One Metal Cylinder Display

Cylinders Sold Separately.

Specify Color: Black (13), Silver (74).

ITEM	DESCRIPTION	LIST PRICE
1134	7½Wx6½Dx17¾H	\$132.40 ea

Optional Cylinders

Available in Six Colors.

Specify Stainless Style: Perforated (39), (Solid).

Specify Melamine Color: Black (13), White (15), Butter

Yellow (61), Terra Cotta (62), Sage (63), Cranberry (64).

ITEM	DESCRIPTION	LIST PRICE
1017-39	4½DIAx5½H	\$14.80 ea
1017-SOLID	4½DIAx5½H	14.80 ea
1017	4½DIAx5½H	18.80 ea



One by One Revolving Cup & Lid Organizer

Holds Cups and Lids Up to 3.75" Diameter.

Specify Color: Black (13), Silver (74).

ITEM	DESCRIPTION	LIST PRICE
1133	10Wx10Dx15¾H	\$159.00 ea



1286-18-13



1286-12-13

One by One Action Stations

GRIDDLE SOLD SEPARATELY.

ITEM	DESCRIPTION	LIST PRICE
Square		
1286-18-13	18¼Wx17¼Dx4½H	\$210.70 ea
1461	Optional Griddle	234.10 ea
3068	Optional Griddle w/ Heat Guard Handles	234.10 ea
Rectangle		
1286-12-13	18Wx9Dx5H	\$187.40 ea
1362	Optional Griddle	123.00 ea
3067	Optional Griddle w/ Heat Guard Handles	123.00 ea



Griddle w/ Heat Guard Handle

ITEM	DESCRIPTION	LIST PRICE
3067	22¾Wx13¾Dx1¼H	\$123.00 ea
3068	23Wx23Dx1¼H	234.10 ea



Griddle Option with Brackets

ITEM	DESCRIPTION	LIST PRICE
1362	22¾Wx13¾Dx1¼H	\$123.00 ea
1461	23Wx23Dx1¼H	234.10 ea



1348-22-13



1409-12-13



1348-12-13

One by One Chafer Alternatives

ITEM	DESCRIPTION	LIST PRICE
1348-12-13	12Wx12Dx4H	\$187.40 ea
1409-12-13	12Wx12Dx7H	187.40 ea
1348-22-13	22Wx12Dx4H	304.40 ea
1409-22-13	22Wx12Dx7H	304.40 ea



One by One Black Chafer

Includes Stainless Steel Chafer Cover.

ITEM	DESCRIPTION	LIST PRICE
3321-13	23Wx14½Dx13½H	\$455.30 ea
3325-55	Replacement Cover	299.90 ea



One by One Ice Housing

Includes Clear Polycarbonate Pan. Specify Color: Black (13), Silver (74).

ITEM	DESCRIPTION	LIST PRICE
1135-12	23½Wx15¾Dx7¼H	\$488.80 ea

Iron Collection

With durable wire, the Iron Collection features functionality and creativity.



Iron Beverage Dispenser BPA FREE
1.5 and 3 Gallon Capacity. Powder Coated Metal Base. Drip Tray Included. Specify Glass or Acrylic.

ITEM	DESCRIPTION	LIST PRICE
1112-1-13	7Wx9Dx19H - Glass	\$462.70 ea
1112-3-13	7Wx9Dx26½H - Glass	498.20 ea
1112-1A-13	7Wx9Dx19H - Acrylic	462.70 ea
1112-3A-13	7Wx9Dx26½H - Acrylic	498.20 ea



Iron Chafer Alternative

ITEM	DESCRIPTION	LIST PRICE
1361-12	12Wx12Dx7½H	\$184.40 ea
1361-22	22Wx12Dx7½H	319.50 ea



Iron Risers

ITEM	DESCRIPTION	LIST PRICE
1247-3	21Wx7½Dx3¾H	\$147.50 ea
1247-7	21Wx7½Dx6½H	159.80 ea
1247-11	21Wx7½Dx11½H	172.00 ea



Optional Griddle with Brackets

ITEM	DESCRIPTION	LIST PRICE
1362	22¾Wx13¾Dx2¼H	\$123.00 ea

a Iron Condiment Organizer

ITEM	DESCRIPTION	LIST PRICE
1252	8½Wx6¾Dx4H	\$100.70 ea



b Iron Napkin Holder

ITEM	NAPKIN SIZE	LIST PRICE
1253	4Wx8H	\$75.60 ea

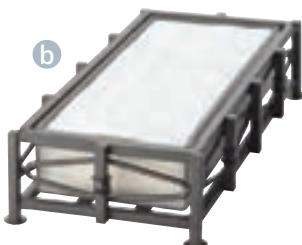

c Iron Coffee Condiment Display

Holds up to 4" Diameter Cups & Lids.

ITEM	DESCRIPTION	LIST PRICE
1453	12Wx10½Dx14½H	\$95.90 ea



d Iron Airpot Display

Drip Tray Included. Airpot Not Included.

ITEM	DESCRIPTION	LIST PRICE
1454	9Wx20½Dx15H	\$87.90 ea



e Iron Cup & Lid Display

Holds up to 4" Diameter Cups & Lids.

ITEM	DESCRIPTION	LIST PRICE
1452	8Wx12Dx15H	\$58.50 ea



f Iron Napkin & Plate Display

ITEM	DESCRIPTION	LIST PRICE
1455	9½Wx14Dx10H	\$64.50 ea



g Iron Signage

ITEM	CARD SIZE	LIST PRICE
1262	3½Wx2H	\$20.10 ea
1264	8½Wx11H	\$35.20 ea

h Iron Ice Housing

Includes Clear Polycarbonate Bin.

ITEM	DESCRIPTION	LIST PRICE
1250-6-13	8Wx7Dx6½H	\$113.20 ea
1250-10-13	12Wx10Dx7H	\$352.50 ea
1250-12-13	20Wx12Dx7H	\$490.90 ea



visit us online at: www.calmil.com **CAL·MIL** call toll-free 800-321-9069

Iron Collection



Iron Arched Stand

Trays and Covers Sold Separately.

ITEM	DESCRIPTION	LIST PRICE
1001	23½Wx12½Dx26H - Frame	\$230.50 ea
325-12-13	12x20 Black Tray	67.50 ea
HU891	Clear Cover w/ Door	123.30 ea



Iron Sloped Rack

Trays and Covers Sold Separately.

ITEM	DESCRIPTION	LIST PRICE
1006	23Wx26Dx13H	\$230.50 ea
325-12-13	12x20 Black Tray	67.50 ea
HU891	Clear Cover w/ Door	123.30 ea



Iron Bowl Display

Covers Do Not Work on These Units.
Plates Not Included.

Frame Only.

Specify Frame Color: Black (13), Chrome (49).

ITEM	DESCRIPTION	LIST PRICE
977-8	8¾Wx8¾Dx18H	\$68.10 ea
977-10	11¾Wx11¾Dx20H	72.00 ea



3 Tier Round Bowl Stand

Frame Only, Bowls Sold Separately.

ITEM	DESCRIPTION	LIST PRICE
C1222-8	8Wx16Dx18H - Black Frame	\$71.20 ea
C1222-10	10Wx18Dx18H - Black Frame	78.30 ea
C1223-8	8Wx16Dx18H - Chrome Frame	85.50 ea
C1223-10	10Wx18Dx18H - Chrome Frame	92.70 ea

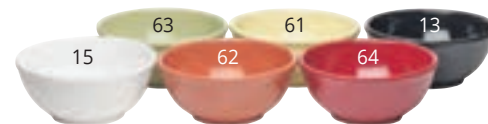

Round Melamine Bowls

BPA FREE

Specify Color: Black (13), White (15), Butter Yellow (61)
Terra Cotta (62), Sage (63), Cranberry (64).

ITEM	DESCRIPTION	LIST PRICE
418-6	6DIAx3H	\$22.20 ea
418-8	8DIAx3½H	33.00 ea
418-10	10DIAx5H	55.70 ea



Iron Straight Front Display Case

Straight Front for Self or Attendant Serve.
Includes 3 Clear Trays.

ITEM	DESCRIPTION	LIST PRICE
1735-1014	16Wx15Dx17½H - 10x14 Tray	\$519.50 ea
1735-1318	19Wx15Dx21¼H - 13x18 Tray	586.10 ea

Replacement Trays

335-10-12	10x14 Replacement Tray	\$32.50 ea
325-13-12	13x18 Replacement Tray	36.50 ea



Iron Curved Front Display Case

Curved Front with 3 Doors. Self Serve.
Includes 3 Clear Trays.

ITEM	DESCRIPTION	LIST PRICE
1708-1014	16Wx15Dx17½H - 10x14 Tray	\$519.50 ea
1708-1318	18Wx16Dx21H - 13x18 Tray	586.10 ea

Replacement Trays

335-10-12	10x14 Replacement Tray	\$32.50 ea
325-13-12	13x18 Replacement Tray	36.50 ea



3 Level Pastry Case

Includes Case and Set Of 13" x 18" Trays.
Specify Color: Black (13), Platinum (39).

ITEM	DESCRIPTION	LIST PRICE
PC300	16Wx20Dx23H	\$1,023.70 ea



2 Level Pastry Case

Includes Case and Set Of Trays.
Specify Color: Black (13), Platinum (39).

ITEM	DESCRIPTION	LIST PRICE
PC200	20Wx16Dx16H	\$861.00 ea



Iron Cup & Lid Organizer

3036-13	4¾W11½xDx11¾H	\$73.70 ea
---------	---------------	------------



1237



1236

Iron Bowl & Plate Holder

ITEM	DESCRIPTION	LIST PRICE
1236	9½Wx9½Dx6½H	\$49.10 ea
1237	6½Wx6½Dx8H	36.90 ea



1239

Iron Cup & Lid Holder

ITEM	DESCRIPTION	LIST PRICE
1238	4½Wx4½Dx8¼H	\$36.90 ea
1239	4½Wx4½Dx8¼H	36.90 ea

visit us online at: www.calmil.com **CAL·MIL** call toll-free 800-321-9069

Classic Collection

The Classic Collection: original and timeless. Made of high impact styrene and ABS.



Classic Airpot Display

Drip Trays Included.
Airpots Not Included.

ITEM	DESCRIPTION	LIST PRICE
360-2	7½Wx23½Dx15¼H	\$168.10 ea

Classic Airpot Display & Condiment Organizer

Drip Tray Included. Airpot Not Included.

ITEM	DESCRIPTION	LIST PRICE
360-4	7½Wx23½Dx15¼H	\$198.80 ea



360-4



Classic Revolving Condiment Display

Has 12 Compartments with Rotating Feature!

ITEM	DESCRIPTION	LIST PRICE
1719	14Wx12½Dx21½ H	\$319.60 ea



Classic Cup & Lid Organizers

Holds up to 3.75" Diameter Cups & Lids.

ITEM	DESCRIPTION	LIST PRICE
2048-3	4½Wx16¼Dx16¼H	\$146.90 ea
2048-4	4½Wx19½Dx19¼H	169.40 ea
2051	4½Wx20Dx19½H	170.00 ea



Classic Adjustable Condiment Organizer

Dividers are Adjustable for Maximum Efficiency.

ITEM	DESCRIPTION	LIST PRICE
1260	12Wx12Dx5½H	\$64.70 ea



Classic Coffee Condiment Organizer

ITEM	DESCRIPTION	LIST PRICE
1259	8Wx12Dx4H	\$53.40 ea



Classic Stackable Cup Dispenser & Condiment Organizer

Pieces Sold Separately.

ITEM	DESCRIPTION	LIST PRICE
2055	6½Wx22¾Dx6½H	\$285.20 ea
2059	6½Wx22¾Dx6¼D	71.20 ea



Classic Cup & Lid Organizer

Fits on top of the 2055.

ITEM	DESCRIPTION	LIST PRICE
3372	6½Wx20Dx6¼H	\$71.20 ea

Classic Flatware/Condiment Organizer

Cylinders Sold Separately. Use for Flatware or Condiments!

ITEM	DESCRIPTION	LIST PRICE
2049	11½Hx15¾Dx15¾H	\$175.20 ea

Optional Cylinders BPA FREE

Available in Six Colors. Specify Stainless Steel Style: Perforated (39), (Solid). Specify Melamine Color: Black (13), White (15), Butter Yellow (61), Terra Cotta (62), Sage (63), Cranberry (64).

ITEM	DESCRIPTION	LIST PRICE
1017-39	4½DIAx5½H	\$14.80 ea
1017-SOLID	4½DIAx5½H	14.80 ea
1017	4½DIAx5½H	18.80 ea



Classic Cup & Lid Organizer with Straw/Stir Stick Holder

Holds Up to 4" Diameter Cups or Lids.

ITEM	DESCRIPTION	LIST PRICE
2041	14½Wx8¾Dx10¾H	\$101.70 ea

Classic Collection



Classic Condiment Organizer

Holds Up to 4" Diameter Cups or Lids.

ITEM	DESCRIPTION	LIST PRICE
2047	14Wx22½Dx20¼H	\$226.00 ea



Classic Condiment Organizer

Has Slot for Standard Napkin Dispenser (Not Included).

Holds Up to 4" Diameter Cups or Lids.

ITEM	DESCRIPTION	LIST PRICE
2042	10Wx17¼Dx14¾H	\$293.80 ea



Classic Cup & Lid Organizer with Coffee Sleeve Dispenser

Coffee Sleeve Dispenser Sold Separately. Holds Up to 4" Diameter Cups or Lids.

ITEM	DESCRIPTION	LIST PRICE
2045	9¾Wx19¼Dx16¾H	\$307.40 ea
2050	Optional Sleeve Dispenser	90.40 ea



Classic Coffee Sleeve Dispenser

ITEM	DESCRIPTION	LIST PRICE
2050	5¾Wx12Dx3¾H	\$90.40 ea



Classic Condiment Organizer

Dividers are Adjustable.

ITEM	DESCRIPTION	LIST PRICE
2040	12Wx8½Dx4¼H	\$56.40 ea



Classic Packet Display

ITEM	DESCRIPTION	LIST PRICE
1246-13	9½Wx4½Dx2¼H	\$30.30 ea



Classic Cup/Lid Organizer

Has Slot for Standard Napkin Dispenser (Not Included). Dividers are Adjustable. Holds up to 4" Diameter Cups & Lids.

ITEM	DESCRIPTION	LIST PRICE
2046	9¾Wx19¼Dx16¾H	\$293.80 ea



Classic Condiment Organizer

Has Slot for Standard Napkin Dispenser (Not Included).

ITEM	DESCRIPTION	LIST PRICE
2043	9Wx19¼Dx16¾H	\$293.80 ea



Classic Condiment Organizer

Has 2 Slots for Standard Napkin Dispensers (Not Included).

ITEM	DESCRIPTION	LIST PRICE
2044	16Wx19¼Dx16¾H	\$372.90 ea

a Classic Vertical Displays

Cylinders Sold Separately on 1016-3 and 1016-6. Set Units Side by Side for More Capacity.

ITEM	DESCRIPTION	LIST PRICE
1016-3	5½Wx8Dx20H	\$139.90 ea
1016-3S	Includes 3 S/S Cylinders	152.60 ea
1016-6	11Wx8Dx20H	192.20 ea

Optional Cylinders BPA FREE

Available in Six Colors.

Specify Stainless Steel Style: Perforated (39), (Solid).

Specify Melamine Color: Black (13), White (15), Butter Yellow (61), Terra Cotta (62), Sage (63), Cranberry (64).

ITEM	DESCRIPTION	LIST PRICE
1017-39	4½DIAx5½H	\$14.80 ea
1017-SOLID	4½DIAx5½H	14.80 ea
1017	4½DIAx5½H	18.80 ea



1016-3

1016-6

b Classic 4 Tier Condiment Display

ITEM	DESCRIPTION	LIST PRICE
1261	6½Wx12Dx20½H	\$73.50 ea

c Classic 3 Tier Condiment Display *New*

ITEM	DESCRIPTION	LIST PRICE
1744	9Wx14Dx21H	\$73.20 ea

d Classic 3 Tier Condiment Display

ITEM	DESCRIPTION	LIST PRICE
2053	5¼W6¾Dx16H	\$73.50 ea
2054	10¼W6¾Dx16H	99.20 ea

e Classic Stir Stick & Condiment Display

Divider is Removable to Create More Capacity.

ITEM	DESCRIPTION	LIST PRICE
2052	5½W13¼Dx14¼H	\$153.60 ea



2054



2053



e



Removable Divider

Classic Collection



Classic Inline
Condiment Organizer

ITEM	DESCRIPTION	LIST PRICE
709-3	7½Wx21DX16H	\$176.10 ea



Classic Dome Lid & Cup Organizer

ITEM	DESCRIPTION	LIST PRICE
724	15½Wx5DX12H	\$106.60 ea



677



P295

Classic Acrylic Bottle Organizer

ITEM	DESCRIPTION	LIST PRICE
P295	12¼Wx10DX4½H - Clear	\$154.80 ea
P296	12Wx14¾DX6¼H - Clear	199.70 ea
P297	12Wx19½DX8¼H - Clear	244.10 ea
677	9½Wx12¾DX6½H - Black	150.30 ea



P297



Stainless Steel Coffee Urn
- Flame Heated

ITEM	DESCRIPTION	LIST PRICE
1009	12Wx12DX26H	\$441.40 ea



Classic 3 Tier
Bottle Organizer

ITEM	DESCRIPTION	LIST PRICE
2056	8½Wx14¾DX6¼H	\$65.80 ea

a Classic Black Amenity Tray

ITEM	DESCRIPTION	LIST PRICE
353-13	15¼Wx12½Dx2H	\$37.90 ea

b Classic Packet Organizer

ITEM	DESCRIPTION	LIST PRICE
399-13	4Wx3Dx3¼H	\$9.40 ea

c Classic K-Cup Holders *New*

ITEM	DESCRIPTION	LIST PRICE
3485-4-13	4½Wx2Dx5¼H - 4 Slots	\$10.00 ea
3485-6-13	6¾Wx2Dx5¼H - 6 Slots	12.00 ea

d Classic Room Service Trays

Specify Color: Black (13), Burl (19).

ITEM	DESCRIPTION	BLACK (13)	BURL (19)
354-1	24Wx18Dx2H	\$57.90 ea	N/A
930-1	22½Wx17Dx1H	53.30 ea	N/A
930-2	16Wx13Dx1H	35.60 ea	N/A
930-3	26Wx18Dx1H	61.70 ea	N/A
958-1	22½Wx17Dx1½H	53.30 ea	97.50 ea
958-2	16Wx13Dx1½H	35.60 ea	71.00 ea



Acrylic Bell Bowls **BPA FREE**

Pebble (34).

ITEM	DESCRIPTION	LIST PRICE
403-10-34	10¼DIAx4¾H	\$29.10 ea
403-15-34	15DIAx7H	57.90 ea
403-18-34	7½DIAx7¾H	77.70 ea

Acrylic Salad Bowls **BPA FREE**

Pebble (34).

ITEM	DESCRIPTION	LIST PRICE
401-12-34	12¼DIAx4H	\$22.50 ea
401-15-34	15DIAx5H	36.10 ea
401-18-34	17¾DIAx5½H	51.10 ea
401-24-34	23½DIAx7¼H	77.70 ea

visit us online at: www.calmil.com **CAL·MIL** call toll-free 800-321-9069

Classic Collection



Classic Napkin & Lid Organizer

Specify Color: Clear (12), Black (13).

ITEM	DESCRIPTION	LIST PRICE
375	13¼Wx5¼Dx8H	\$101.70 ea



Classic Napkin, Lid, & Condiment Organizer

Hardware Not Included.

ITEM	DESCRIPTION	LIST PRICE
387-13	17½Wx5Dx8H	\$139.40 ea



299

787

298

Classic Napkin, Lid, & Straw Organizer

Counter Top or Wall Mount. Hardware Not Included. Specify Color: Clear (12), Black (13).

ITEM	DESCRIPTION	LIST PRICE
298	4½Wx4½Dx8H	\$37.90 ea
299	5¼Wx5¼Dx8H	40.10 ea
787	4¼Wx4¼Dx6H	35.60 ea



Classic Cup & Lid Organizer

Counter Top or Wall Mount. Hardware Not Included.

ITEM	DESCRIPTION	LIST PRICE
1013	13½Wx7¼Dx11½H	\$119.40 ea



Classic Napkin & Lid Organizer

Specify Color: Clear (12), Black (13).

ITEM	DESCRIPTION	LIST PRICE
376	17½Wx5Dx8H	\$128.40 ea



Classic Napkin Organizer

Specify Color: Clear (12), Black (13).

ITEM	NAPKIN SIZE	LIST PRICE
635	5Wx5H	\$40.10 ea



Classic Napkin & Lid Organizer

ITEM	DESCRIPTION	LIST PRICE
377-12	26½Wx5Dx6H	\$143.70 ea



Classic Salsa/Condiment Bar BPA FREE

Complete Set w/Pans as Shown.

ITEM	DESCRIPTION	LIST PRICE
658	14Wx15Dx20H	\$159.80 ea
1102	20½Wx12¾Dx19¾H	256.10 ea



Chilled Salsa/Dressing Server

Fill Bottom of Bin with Ice and Serve!
Includes 4 White Crocks.

ITEM	DESCRIPTION	LIST PRICE
3369-13	10½Wx10½Dx7H	\$164.80 ea



Melamine Housing

Includes Clear Polycarbonate Bin.
Specify Color: Black (13), White (15).

ITEM	DESCRIPTION	LIST PRICE
475-6	6Wx7Dx7H	\$69.20 ea
475-10	10Wx12Dx7H	132.20 ea
475-12	12Wx20Dx7H	188.80 ea



Revolving Salad Server

ITEM	DESCRIPTION	LIST PRICE
1014	18Wx18Dx9½H	\$349.60 ea



Classic Dress Up Cover

Durable ABS.

ITEM	DESCRIPTION	LIST PRICE
761-13	22Wx16Dx8H	\$132.80 ea
142	Black Pan	26.90 ea



Cereal Dispensers



a

a Triple Cylinder Cereal Dispenser *New*

5 Liter Capacity. Features Turn and Serve Mechanism.

ITEM	DESCRIPTION	LIST PRICE
3517-3-39	18½Wx6Dx22½H	\$510.00 ea

b Double Cylinder Cereal Dispensers *New*

5 Liter Capacity Per Cylinder. Black (13), Beechwood (98).

ITEM	DESCRIPTION	LIST PRICE
------	-------------	------------

Turn and Serve

3516-2-13	12¾WX11DX25¾H	\$590.00 ea
3516-2-98	12¾WX11DX25¾H	590.00 ea

Free Flow

3516-2-13FF	12¾WX11DX25¾H	\$590.00 ea
3516-2-98FF	12¾WX11DX25¾H	590.00 ea

c 3 and 5 Cylinder Cereal Dispensers *New*

5 Liter Capacity Per Cylinder. Black (13), Beechwood (98).

ITEM	DESCRIPTION	LIST PRICE
------	-------------	------------

Turn and Serve

3516-3-13	19Wx11Dx25¾H	\$735.00 ea
3516-3-98	19Wx11Dx25¾H	735.00 ea
3516-5-13	31¼Wx11Dx25¾H	1,150.00 ea
3516-5-98	31¼Wx11Dx25¾H	1,150.00 ea

Free Flow

3516-3-13FF	19Wx11Dx25¾H	\$735.00 ea
3516-3-98FF	19Wx11Dx25¾H	735.00 ea
3516-5-13FF	31¼Wx11Dx25¾H	1,150.00 ea
3516-5-98FF	31¼Wx11Dx25¾H	1,150.00 ea

d Wall Mount Cereal Dispensers *New*

5 Liter Capacity Per Cylinder. Hardware Not Included.

ITEM	DESCRIPTION	LIST PRICE
------	-------------	------------

Turn and Serve

3518-3-39	18½Wx6¾Dx19¾H	\$440.00 ea
3518-5-39	31Wx6½DX19¾H	780.00 ea

Free Flow

3518-3-39FF	18½Wx6¾Dx19¾H	\$440.00 ea
3518-5-39FF	40Wx6½Dx19¾H	780.00 ea



b

3516-2-98



c

3516-3-13

Turn and Serve Dispenser



Turn the Handle to Rotate the Internal 6-Wing Mechanism.

Free Flow Dispenser



Hold Down the Handle for Free Flow. Release When Desired Amount is Dispensed.



d

3518-3-39FF



a Beechwood 13.5 Liter Cereal Dispenser *New*

Features Turn and Serve Mechanism.

ITEM	DESCRIPTION	LIST PRICE
3513-1-98	11¾Wx11Dx31H	\$765.00 ea



b Black 13.5 Liter Cylinder Dispenser *New*

Features Turn and Serve Mechanism.

ITEM	DESCRIPTION	LIST PRICE
3513-1-13	11¾Wx11Dx31H	\$765.00 ea

c Large Double Cylinder Dispenser *New*

Features Turn and Serve Mechanism.

13.5 Liter Capacity Per Cylinder.

Black (13), Beechwood (98).

ITEM	DESCRIPTION	LIST PRICE
3513-2-13	20Wx11Dx31H	\$1,150.00 ea
3513-2-98	20Wx11Dx31H	1,150.00 ea



d Wall Mount Double Dispenser *New*

Features Turn and Serve Mechanism.

13.5 Liter Capacity Per Cylinder.

Hardware Not Included.

ITEM	DESCRIPTION	LIST PRICE
3519-2-39	20¼Wx9¼Dx25¼H	\$900.00 ea

e Wall Mount 5 Cylinder Dispenser *New*

Features Turn and Serve Mechanism.

4.5 Liter Capacity Per Cylinder.

Hardware Not Included.

ITEM	DESCRIPTION	LIST PRICE
3520-5-39	27¾Wx6½Dx21¾H	\$1,160.00 ea

f 5 Cylinder Cereal Dispenser *New*

Features Turn and Serve Mechanism.

4.5 Liter Capacity Per Cylinder.

ITEM	DESCRIPTION	LIST PRICE
3515-5-98	27Wx11Dx28H	\$1,580.00 ea

Turn and Serve Dispenser



Turn the Handle to Rotate the Internal 6-Wing Mechanism.



Cereal Dispensers



a Double Cylinder Dispenser *New*

3.5 Liter Capacity Per Cylinder.

ITEM	DESCRIPTION	LIST PRICE
3510-2-39	12¼Wx6Dx17¾H	\$262.00 ea

b Triple Cylinder Dispenser *New*

3.5 Liter Capacity Per Cylinder.

ITEM	DESCRIPTION	LIST PRICE
3510-3-39	18½Wx6Dx17¾H	\$340.00 ea

c Stainless Double Dispenser *New*

3.5 Liter Capacity Per Cylinder.

ITEM	DESCRIPTION	LIST PRICE
3511-2-55	12¼Wx6Dx17¾H	\$440.00 ea

d Stainless Triple Dispenser *New*

3.5 Liter Capacity Per Cylinder.

ITEM	DESCRIPTION	LIST PRICE
3511-3-55	18½Wx6Dx17¾H	\$600.00 ea



e Rotating Cereal Dispenser *New*

4 Cylinders Total, 3.5 Liter Per Cylinder.

ITEM	DESCRIPTION	LIST PRICE
3514-4-39	13½Wx13½Dx17¾H	\$590.00 ea

f Wall Mount Single Dispenser *New*

3.5 Liter Capacity. Hardware Not Included.

ITEM	DESCRIPTION	LIST PRICE
3512-1-39	6Wx6Dx12¼H	\$130.00 ea



Portion Control Coffee & Powder Dispensers

a Wall Mount Click Dispensers *New*

Hardware Not Included.
1 Liter Capacity Per Cylinder.
1 Click Dispenses an Exact Teaspoon.

ITEM	DESCRIPTION	LIST PRICE
3526-2-13	1 Sugar/1 Powder	\$275.00 ea
3526-3-13	1 Sugar/2 Powder	400.00 ea



b Freestanding Click Dispensers *New*

1 Liter Capacity Per Cylinder.
1 Click Dispenses an Exact Teaspoon.

ITEM	DESCRIPTION	LIST PRICE
3527-1-13	Single Sugar Dispenser	\$265.00 ea
3527-2-13	1 Sugar/1 Powder	315.00 ea
3527-3-13	1 Sugar/2 Powder	475.00 ea



Portion:
One
Teaspoon



c Wall Mount Tea Dispensers *New*

Portion Controlled Topping Dispenser Includes
5 Interchangeable Portion Cassettes from 2-7 Tsp.
Wall Mounting Hardware Not Included.

ITEM	DESCRIPTION	LIST PRICE
3533-1-13	6¼Wx7¼Dx9½H - 1.5 Liter	\$190.00 ea
3523-1-13	6WX6DX16H - 5 Liter	210.00 ea

Replacement Portion Cassette Pack		LIST PRICE
3530-PKIT	10,15,20,30, and 35 CC's	\$20.00 ea



d Freestanding Tea Dispensers *New*

Portion Controlled Topping Dispenser Includes
5 Interchangeable Portion Cassettes from 2-7 Tsp.
Wall Mounting Hardware Not Included.

ITEM	DESCRIPTION	LIST PRICE
3524-1-13	6¼WX8DX16¼H - 1.5 Liter	\$265.00 ea
3534-1-13	6WX8DX23H - 5 Liter	285.00 ea

Replacement Portion Cassette Pack		LIST PRICE
3530-PKIT	10,15,20,30, and 35 CC's	\$20.00 ea



3533-1-13



3523-1-13



3534-1-13

3524-1-13

Portion:
Two to Seven
Teaspoons



visit us online at: www.calmil.com **CAL-MIL** call toll-free 800-321-9069

Portion Control Powder



a 1.5 Liter Wall Mount Dispenser *New*

Portion Controlled Topping Dispenser Includes 5 Interchangeable Portion Cassettes from 2-7 Tsp. Wall Mounting Hardware Not Included.

ITEM	DESCRIPTION	LIST PRICE
3531-1-13	6¼Wx7¾Dx9½H	\$190.00 ea

Replacement Portion Cassette Pack
3530-PKIT 10,15,20,30, and 35 CC's \$20.00 ea

b 5 Liter Wall Mount Dispenser *New*

Portion Controlled Topping Dispenser Includes 5 Interchangeable Portion Cassettes from 2-7 Tsp. Wall Mounting Hardware Not Included.

ITEM	DESCRIPTION	LIST PRICE
3521-1-13	6WX6DX16H	\$210.00 ea

Replacement Portion Cassette Pack
3530-PKIT 10,15,20,30, and 35 CC's \$20.00 ea

c 1.5 Liter Freestanding Dispenser *New*

Portion Controlled Topping Dispenser Includes 5 Interchangeable Portion Cassettes from 2-7 Tsp.

ITEM	DESCRIPTION	LIST PRICE
3522-1-13	6¼WX8DX16¼H	\$265.00 ea

Replacement Portion Cassette Pack
3530-PKIT 10,15,20,30, and 35 CC's \$20.00 ea

d 5 Liter Freestanding Dispenser *New*

Portion Controlled Topping Dispenser Includes 5 Interchangeable Portion Cassettes from 2-7 Tsp.

ITEM	DESCRIPTION	LIST PRICE
3532-1-13	6WX8DX23H	\$285.00 ea

Replacement Portion Cassette Pack
3530-PKIT 10,15,20,30, and 35 CC's \$20.00 ea



Dispense Exact Portions of Protein Powders, Supplements, Drink Mixes, Spices, and More!



Portion Control System



a 1.5 Liter Wall Mount Dispenser *New*

Portion Controlled Topping Dispenser Includes 5 Interchangeable Portion Cassettes from 2-7 Tsp. Wall Mounting Hardware Not Included.

ITEM	DESCRIPTION	LIST PRICE
3533-1-13	6¼Wx7¾Dx9½H	\$190.00 ea

Replacement Portion Cassette Pack		
ITEM	DESCRIPTION	LIST PRICE
3530-PKIT	10,15,20,30, and 35 CC's	\$20.00 ea

b 5 Liter Wall Mount Dispenser *New*

Portion Controlled Topping Dispenser Includes 5 Interchangeable Portion Cassettes from 2-7 Tsp. Wall Mounting Hardware Not Included.

ITEM	DESCRIPTION	LIST PRICE
3523-1-13	6WX6DX16H	\$210.00 ea

Replacement Portion Cassette Pack		
ITEM	DESCRIPTION	LIST PRICE
3530-PKIT	10,15,20,30, and 35 CC's	\$20.00 ea

c 5 Liter Freestanding Dispenser *New*

Portion Controlled Topping Dispenser Includes 5 Interchangeable Portion Cassettes from 2-7 Tsp.

ITEM	DESCRIPTION	LIST PRICE
3534-1-13	6WX8DX23H	\$285.00 ea

Replacement Portion Cassette Pack		
ITEM	DESCRIPTION	LIST PRICE
3530-PKIT	10,15,20,30, and 35 CC's	\$20.00 ea

d 1.5 Liter Freestanding Dispenser *New*

Portion Controlled Topping Dispenser Includes 5 Interchangeable Portion Cassettes from 2-7 Tsp.

ITEM	DESCRIPTION	LIST PRICE
3524-1-13	6¼WX8DX16¼H	\$265.00 ea

Replacement Portion Cassette Pack		
ITEM	DESCRIPTION	LIST PRICE
3530-PKIT	10,15,20,30, and 35 CC's	\$20.00 ea



Portion: Two to Seven Teaspoons

e Triple Cylinder Click Dispensers *New*

Portion Control Mechanism Ensures Equal Portions Without Any Damage and with a Simple Click! Wall Mount Only, Hardware Not Included. 1 Liter Capacity. Specify Color: Red (14), Green (40), Yellow (42), Purple (79), or Orange (80).

ITEM	DESCRIPTION	LIST PRICE
3525-3	15¼Wx7¼Dx12H	\$470.00 ea

Portion: One Teaspoon



Purple (79) Orange (80) Green (40) Yellow (42) Red (14)



Bulk Food Dispensers



a

Turn and Serve Dispenser



Turn the Handle to Rotate the Internal 6-Wing Mechanism.

Free Flow Dispenser



Hold Down the Handle for Free Flow. Release When Desired Amount is Dispensed.

a Wall Mount 5 Cylinder Dispenser *New*

5 Liter Capacity Per Cylinder.
Hardware Not Included.

ITEM	DESCRIPTION	LIST PRICE
Turn and Serve		
3518-5-39	31WX6½DX19¾H	\$780.00 ea
Free Flow		
3518-5-39FF	31WX6½DX19¾H	780.00 ea



b

b Wall Mount Triple Cylinder Dispenser *New*

5 Liter Capacity Per Cylinder.
Hardware Not Included.

ITEM	DESCRIPTION	LIST PRICE
Turn and Serve		
3518-3-39	18½WX6¾DX19¾H	\$440.00 ea
Free Flow		
3518-3-39FF	18½WX6¾DX19¾H	440.00 ea



c

c Wall Mount 5 Cylinder Dispenser *New*

5 Liter Capacity Per Cylinder.
Hardware Not Included.

ITEM	DESCRIPTION	LIST PRICE
Turn and Serve		
3518-5-39	31WX6½DX19¾H	\$780.00 ea
Free Flow		
3518-5-39FF	31WX6½DX19¾H	780.00 ea



Bulk Food Dispensers



a Wall Mount Bulk Coffee Dispenser *New*
Keeps Coffee Beans Fresh and Preserved.
13.5 Liter Capacity Per Cylinder.
Hardware Not Included.

ITEM	DESCRIPTION	LIST PRICE
3529-2-11	20¼Wx9¼Dx25¼H	\$840.00 ea

For Coffee Only



b Wall Mount Triple Cylinder Coffee Dispenser *New*
Keeps Coffee Beans Fresh and Preserved.
4.5 Liter Capacity Per Cylinder.
Hardware Not Included.

ITEM	DESCRIPTION	LIST PRICE
3528-3-11	16¾Wx6½Dx21¾H	\$1,050.00 ea



c Wall Mount Double Dispenser *New*
Features Turn and Serve Mechanism.
13.5 Liter Capacity Per Cylinder.
Hardware Not Included.

ITEM	DESCRIPTION	LIST PRICE
3519-2-39	20¼Wx9¼Dx25¼H	\$900.00 ea

d Wall Mount 5 Cylinder Dispenser *New*
Features Turn and Serve Mechanism.
4.5 Liter Capacity Per Cylinder.
Hardware Not Included.

ITEM	DESCRIPTION	LIST PRICE
3520-5-39	27½Wx6½Dx21¾H	\$1,160.00 ea



visit us online at: www.calmil.com **CAL-MIL** call toll-free 800-321-9069

Cereal Dispensers



Turntable Cereal Dispensers BPA FREE

ITEM	DESCRIPTION	LIST PRICE
723	12Wx12Dx20H - ABS Base	\$588.50 ea
723-53	12Wx12Dx20H - Wood Base	588.50 ea



Bamboo Chilled Condiment Jar Display

Complete Set with Cold Pucks. Place Pucks in Freezer for a Minimum of 6 Hours. Keeps Contents Cold for Hours!

ITEM	DESCRIPTION	LIST PRICE
1850-4-60	16Wx6Dx4H	\$144.60 ea
1850-4-60HL	16Wx6Dx4H	171.40 ea



Multi-Level Chilled Condiment Displays ❄️

Complete Set with Cold Pucks. Place Pucks in Freezer for a Minimum of 6 Hours. Keeps Contents Cold for Hours! Specify Lid Type.

ITEM	DESCRIPTION	LIST PRICE
16 oz. Jar Units (14Wx11Dx11¼H)		
1855-4-55	w/ Solid Stainless Steel Lids	\$167.10 ea
1855-4-55HL	w/ Hinged Stainless Steel Lids	199.20 ea
1855-4-55NL	w/ Notched S/S Lids	199.20 ea
32 oz. Jars Units (16Wx12Dx11¼H)		
1855-5-55	w/ Solid Stainless Steel Lids	\$221.80 ea
1855-5-55HL	w/ Hinged Stainless Steel Lids	253.90 ea
1855-5-55NL	w/ Notched Stainless Steel Lids	253.90 ea



Chilled Condiment Displays ❄️

Complete Set with Cold Pucks. Place Pucks in Freezer for a Minimum of 6 Hours. Keeps Contents Cold for Hours! Specify Lid Type.

ITEM	DESCRIPTION	LIST PRICE
16 oz. Jar Units (13¼Wx5Dx4¼H)		
1850-4-55	w/ Solid Stainless Steel Lids	\$144.60 ea
1850-4-55HL	w/ Hinged Stainless Steel Lids	176.70 ea
1850-4-55NL	w/ Notched S/S Lids	176.70 ea
32 oz. Jar Units (16½Wx6Dx5¾H)		
1850-5-55	w/ Solid Stainless Steel Lids	\$211.00 ea
1850-5-55HL	w/ Hinged Stainless Steel Lids	253.90 ea
1850-5-55NL	w/ Notched S/S Lids	253.90 ea

a Madera Three Section Cereal Dispenser New

600 Cubic Inch Capacity Per Bin.

ITEM	DESCRIPTION	LIST PRICE
3434-99	18Wx14½Dx24H	\$800.00 ea



b Urban Cereal Dispenser

ITEM	DESCRIPTION	LIST PRICE
3401-55	17½Wx13½Dx24H	\$1,081.50 ea

c Luxe Three Section Cereal Dispenser

ITEM	DESCRIPTION	LIST PRICE
3019-55	17½Wx13½Dx24H	\$1,156.50 ea



d Eco Modern Cereal Dispenser BPA FREE

942 Cubic Inch Capacity.

ITEM	DESCRIPTION	LIST PRICE
1499	18¼Wx13¾Dx24½H	\$721.60 ea

e Portion Control Cereal Dispenser

600 Cubic Inch Capacity Per Bin.

ITEM	DESCRIPTION	LIST PRICE
718	17Wx13¾Dx22H	\$1,156.50 ea



visit us online at: www.calmil.com **CAL·MIL** call toll-free 800-321-9069

Cereal Dispensers



Single Cereal Dispenser

ITEM	DESCRIPTION	LIST PRICE
CR400	11Wx14Dx28H	\$556.20 ea



Dual Cereal Dispenser

ITEM	DESCRIPTION	LIST PRICE
CR402	22Wx14Dx28H	\$721.00 ea



Box Cereal Organizer

ITEM	DESCRIPTION	LIST PRICE
3364	16½Wx16½Dx12¼H	\$736.50 ea



Revolving Cereal Cup Dispenser

ITEM	DESCRIPTION	LIST PRICE
1539-12	10Wx10Dx16¾H	\$114.00 ea

a Counter Top Cereal Merchandiser

ITEM	DESCRIPTION	LIST PRICE
639	15Wx13¼Dx20H	\$191.00 ea

Note: The use of Kellogs, General Mills & Post cereals does not constitute any endorsement by these companies.



b Mission Wire Merchandisers

Specify Color: Black (13), Platinum (39).

ITEM	DESCRIPTION	LIST PRICE
1702	13½Wx15Dx16½H	\$186.50 ea

c Counter Top Cereal Merchandisers

372 Revolves.

ITEM	DESCRIPTION	LIST PRICE
370	12½Wx16Dx15H	\$203.10 ea
372	12½Wx16Dx15H	218.50 ea

d Bulk Cereal Dispenser

900 Cubic Inch Capacity.

ITEM	DESCRIPTION	LIST PRICE
766	7½Wx16Dx20H	\$437.00 ea

e Portion Control Bulk Cereal Dispenser

900 Cubic Inch Capacity.

ITEM	DESCRIPTION	LIST PRICE
642	7Wx15½Dx20H	\$463.70 ea

f Stackable Bulk Cereal Dispenser

450 Cubic Inch Capacity.

ITEM	DESCRIPTION	LIST PRICE
656	10Wx8Dx14H	\$198.90 ea



372



370



d



e



f

Beverage Dispensers



Stainless Steel Beverage Dispenser

Available in 3 Gallon Capacity. Polycarbonate Tank. Includes Drip Tray.

ITEM	DESCRIPTION	LIST PRICE
3324-3-55	7½Wx9½Dx23½H - Ice Chamber	\$246.80 ea
3324-3INF-55	7½Wx9½Dx23½H - Infusion Chamber	246.80 ea



Square Stainless Steel Beverage Dispensers

Includes Chrome Drip Tray, Acrylic Tank with Stainless Steel Base, Lid, and Chamber.

ITEM	DESCRIPTION	LIST PRICE
1991-3-55	7¼Wx9½Dx24½H - Ice Chamber	\$603.40 ea
1991-3INF-55	7¼Wx9½Dx24½H - Infusion Chamber	603.40 ea



Round Stainless Steel Beverage Dispensers

Includes Chrome Drip Tray, Acrylic Tank with Stainless Steel Base, Lid, and Chamber.

ITEM	DESCRIPTION	LIST PRICE
1990-3-55	8¼Wx10½Dx23½H - Ice Chamber	\$603.40 ea
1990-3INF-55	8¼Wx10½Dx23½H - Infusion Chamber	603.40 ea

a Industrial Glass Beverage Dispenser

2 Gallon Capacity. Includes Chamber and Drip Tray.

ITEM	DESCRIPTION	LIST PRICE
3421-2	10¾Wx11½Dx22¾H - Ice Chamber	\$441.40 ea
3421-2INF	10¾Wx11½Dx22¾H - Infusion Chamber	441.40 ea



b Industrial Acrylic Beverage Dispenser *New*

3 Gallon Capacity. Includes Chamber and Drip Tray.

ITEM	DESCRIPTION	LIST PRICE
3436-3	8½Wx8¾Dx26H - Ice Chamber	\$498.20 ea
3436-3INF	8½Wx8¾Dx26H - Infusion Chamber	498.20 ea

c Urban Beverage Dispenser

3 Gallon Capacity. Includes Chamber and Drip Tray. Stainless Steel (55).

ITEM	DESCRIPTION	LIST PRICE
3394-3-55	8Wx8Dx24H - Ice Chamber	\$498.20 ea
3394-3INF-55	8Wx8Dx24H - Infusion Chamber	498.20 ea



d Luxe Acrylic Beverage Dispenser ^{BPA FREE}

3 Gallon Capacity. Includes Chamber and Drip Tray. Stainless Steel (55).

ITEM	DESCRIPTION	LIST PRICE
3002-3-55	7¾Wx7¾Dx25¾H - Ice Chamber	\$498.20 ea
3002-3INF-55	7¾Wx7¾Dx25¾H - Infusion Chamber	498.20 ea

e Stainless Steel Glass Beverage Dispenser

2 Gallon Capacity. Includes Chamber and Drip Tray.

ITEM	DESCRIPTION	LIST PRICE
1111-55	10¾Wx11½Dx22¾H - Ice Chamber	\$441.40 ea
1111INF-55	10¾Wx11½Dx22¾H - Infusion Chamber	441.40 ea

f Octagon Stainless Steel Acrylic Beverage Dispenser

3 Gallon Capacity, Includes Drip Tray and Ice Chamber.

ITEM	DESCRIPTION	LIST PRICE
152-SS	11Wx11Dx23½H	\$1,013.60 ea

g Stainless Steel Polycarbonate Beverage Dispenser

3 Gallon Capacity. Ice or Infusion Chamber Included.

ITEM	DESCRIPTION	LIST PRICE
1282-3A	14Wx10½Dx26½H - Ice Chamber	\$498.20 ea
1282-3AINF	14Wx10½Dx26½H - Infusion Chamber	498.20 ea



visit us online at: www.calmil.com **CAL·MIL** call toll-free 800-321-9069

Beverage Dispensers



Midnight Bamboo Acrylic Beverage Dispensers BPA FREE

1.5 and 3 Gallon Capacities.
Includes Drip Tray.

ITEM	DESCRIPTION	LIST PRICE
Ice Chamber		
1527-1-96	8¼Wx9¾Dx17¾H	\$462.70 ea
1527-3-96	8¼Wx9¾Dx25¾H	498.20 ea
Infusion Chamber		
1527-1INF-96	8¼Wx9¾Dx17¾H	462.70 ea
1527-3INF-96	8¼Wx9¾Dx25¾H	498.20 ea



Bamboo and Midnight Bamboo Crate Acrylic Beverage Dispensers BPA FREE

3 Gallon Capacity.
Specify Color: Bamboo (60), Midnight Bamboo (96).

ITEM	DESCRIPTION	LIST PRICE
Ice Chamber		
3301-3	8Wx8Dx25½H	\$498.20 ea
Infusion Chamber		
3301-3INF	8Wx8Dx25½H	498.20 ea



Bamboo Acrylic Beverage Dispensers BPA FREE

1.5 and 3 Gallon Capacities.
Includes Drip Tray and Chamber.

ITEM	DESCRIPTION	LIST PRICE
Ice Chamber		
1527-1-60	8¼Wx9¾Dx17¾H	\$462.70 ea
1527-3-60	8¼Wx9¾Dx25¾H	498.20 ea
Infusion Chamber		
1527-1INF-60	8¼Wx9¾Dx17¾H	462.70 ea
1527-3INF-60	8¼Wx9¾Dx25¾H	498.20 ea



Madera Glass Beverage Dispenser New

Includes Glass Dispenser, Base, and Chamber.

ITEM	DESCRIPTION	LIST PRICE
3422-2	10¾Wx11½Dx22¾H - Ice	\$441.40 ea
3422-2INF	10¾Wx11½Dx22¾H - Infusion	441.40 ea



Madera Acrylic Beverage Dispenser New

3 Gallon Capacity.
Reclaimed Wood (99).

ITEM	DESCRIPTION	LIST PRICE
1527-3-99	8½Wx8½Dx26¾H - Ice	\$498.20 ea
1527-3INF-99	8½Wx8½Dx26¾H - Infusion	498.20 ea



Madera Porcelain Beverage Dispenser New

Base and Dispenser Sold Separately.
Chalkboard Urn Sign Included with Dispenser.

ITEM	DESCRIPTION	LIST PRICE
3460-1BEV	1.5 Gallon Dispenser	\$220.00 ea
432-6-99	12Wx12Dx6H Base	120.00 ea

a Square Clear Beverage Dispensers BPA FREE

1.5, 3, and 5 Gallon Capacities Available.
Includes Drip Tray and Chamber.

ITEM	DESCRIPTION	LIST PRICE
Ice Chamber		
1112-1	7¼Wx9¼Dx18½H - Glass	\$451.90 ea
1112-3	7¼Wx9¼Dx26½H - Glass	486.60 ea
1112-1A	7¼Wx9¼Dx18½H - Acrylic	462.70 ea
1112-3A	7¼Wx9¼Dx26½H - Acrylic	498.20 ea
1112-5A	9Wx11½Dx29¼H - Acrylic	685.60 ea
Infusion Chamber		
1112-1INF	7¼Wx9¼Dx18½H - Glass	\$451.90 ea
1112-3INF	7¼Wx9¼Dx26½H - Glass	486.60 ea
1112-1AINF	7¼Wx9¼Dx18½H - Acrylic	462.70 ea
1112-3AINF	7¼Wx9¼Dx26½H - Acrylic	498.20 ea
1112-5AINF	9Wx11½Dx29¼H - Acrylic	685.60 ea

b Square Acrylic Beverage Dispensers with Handles BPA FREE

3 and 5 Gallon Capacities.
Includes Drip Tray and Chamber.

ITEM	DESCRIPTION	LIST PRICE
Ice Chamber		
1112-3AH	7¼Wx9¼Dx26½H - 3 Gallon	\$498.20 ea
1112-5AH	9Wx11½Dx29¼H - 5 Gallon	685.60 ea
Infusion Chamber		
1112-3AINFH	7¼Wx9¼Dx18½H - 3 Gallon	\$498.20 ea
1112-5AINFH	9Wx11½Dx29¼H - 5 Gallon	685.60 ea

c Glacier Acrylic Beverage Dispensers

2 and 3 Gallon Capacities. Includes Drip Tray.

ITEM	DESCRIPTION	LIST PRICE
Ice Chamber		
932-2	10Wx10Dx20H	\$591.10 ea
932-3	11Wx11Dx22H	764.20 ea
Infusion Chamber		
932-2INF	10Wx10Dx20H	\$591.10 ea
932-3INF	11Wx11Dx22H	764.20 ea

d Iron Beverage Dispensers

2 Gallon Capacity. Includes Drip Tray.

ITEM	DESCRIPTION	LIST PRICE
Ice Chamber		
1111	10¾Wx11½Dx22¾H - Glass	\$441.40 ea
1111A	10Wx10Dx22H - Acrylic	452.00 ea
Infusion Chamber		
1111INF	10¾Wx11½Dx22¾H - Glass	441.40 ea

e Classic Dual Chamber Acrylic Dispenser

5 Gallon Capacity and Includes Drip Trays.

ITEM	DESCRIPTION	LIST PRICE
971-5-17	13Wx13Dx22H	\$953.00 ea

f Classic Octagon Acrylic Dispenser

Includes Drip Tray and Chamber.

ITEM	DESCRIPTION	LIST PRICE
Ice Chamber		
972-1-17	11Wx11Dx18H - 1.5 Gallon	\$545.80 ea
972-2-17	10Wx10Dx20H - 2 Gallon	591.10 ea
972-3-17	11Wx11Dx22H - 3 Gallon	764.20 ea
972-5-17	13Wx13Dx22H - 5 Gallon	953.00 ea
Infusion Chamber		
972-1-17INF	11Wx11Dx18H - 1.5 Gallon	\$545.80 ea
972-2-17INF	10Wx10Dx20H - 2 Gallon	591.10 ea
972-3-17INF	11Wx11Dx22H - 3 Gallon	764.20 ea
972-5-17INF	13Wx13Dx22H - 5 Gallon	953.00 ea



With Handles



Beverage Dispensers



Stainless Steel/Acrylic Beverage Dispenser

2 Gallon Capacity.

ITEM	DESCRIPTION	LIST PRICE
Ice Chamber		
1010	10Wx14Dx23H	\$498.20 ea
Infusion Chamber		
1010INF	10Wx14Dx23H	498.20 ea



Dual Stainless Steel/Acrylic Beverage Dispensers

Total Capacity is 4 Gallon, 2 Gallon Each.

ITEM	DESCRIPTION	LIST PRICE
155	22Wx14Dx23H	\$1,034.50 ea



Tall Stainless Steel Acrylic Beverage Dispenser

1.5 Gallon Capacity. Includes Ice Chamber Only.

ITEM	DESCRIPTION	LIST PRICE
1494	7Wx12Dx30H	\$756.40 ea



Metal Band Beverage Dispensers

Metal Band with Polycarbonate Tank and Base. Includes Drip Tray. 3 Gallon Capacity. Specify Color: Black (13) or Silver (74).

ITEM	DESCRIPTION	LIST PRICE
Ice Chamber		
2016	8Wx10Dx24H	\$246.80 ea
Infusion Chamber		
2016INF	8Wx10Dx24H	246.80 ea



Soho Round Glass Beverage Dispensers BPA FREE

2 and 3 Gallon Capacities.

Includes Drip Tray.

Specify Color: Black (13) or Silver (74).

ITEM	DESCRIPTION	LIST PRICE
Ice Chamber		
1580-2	10Wx12Dx20½H	\$462.70 ea
1580-3	10Wx12Dx24½H	498.20 ea
Infusion Chamber		
1580-2INF	10Wx12Dx20½H	462.70 ea
1580-3INF	10Wx12Dx24½H	498.20 ea



Union Square Beverage Dispenser

3 Gallon Capacity.

Includes Chamber and Drip Tray.

ITEM	DESCRIPTION	LIST PRICE
Ice Chamber		
3370-3-13	8½Wx9Dx23½H	\$498.20 ea
Infusion Chamber		
3370-3INF-13	8½Wx9Dx23½H	498.20 ea

a One by One Acrylic Beverage Dispenser with Handles

Available in 3 Gallon Capacity Only.
Includes Drip Tray and Clear Insert to Secure Lids.
Specify Color: Black (13), Silver (74).

ITEM	DESCRIPTION	LIST PRICE
Ice Chamber		
3302-3	9Wx9Dx28½H	\$597.60 ea
Infusion Chamber		
3302-3INF	9Wx9Dx28½H	597.60 ea



Chamber Lock



b One by One Acrylic Beverage Dispensers BPA FREE

Includes Drip Tray and Chamber.
Specify Color: Black (13), Silver (74).

ITEM	DESCRIPTION	LIST PRICE
Ice Chamber		
1132-1	10¼Wx10½Dx17¾H - 1.5 Gallon	\$462.70 ea
1132-3	10¼Wx10½Dx25½H - 3 Gallon	498.00 ea
1132-5	11¾Wx11¾Dx29H - 5 Gallon	685.60 ea
Infusion Chamber		
1132-1INF	10¼Wx10½Dx17¾H - 1.5 Gallon	\$462.70 ea
1132-3INF	10¼Wx10½Dx25½H - 3 Gallon	498.00 ea
1132-5INF	11¾Wx11¾Dx29H - 5 Gallon	685.60 ea



c Westport Wood Acrylic Beverage Dispensers BPA FREE

1.5 and 3 Gallon Capacities.
Includes Drip Tray.

ITEM	DESCRIPTION	LIST PRICE
Ice Chamber		
1527-1-52	8¼Wx9¾Dx17¾H	\$462.70 ea
1527-3-52	8¼Wx9¾Dx25¾H	498.20 ea
Infusion Chamber		
1527-1INF-52	8¼Wx9¾Dx17¾H	\$462.70 ea
1527-3INF-52	8¼Wx9¾Dx25¾H	498.20 ea

d Squared Acrylic Beverage Dispensers BPA FREE

1.5 and 3 Gallon Capacities. Includes Drip Tray.
Specify Color: Black (13), Stainless Steel (55).

ITEM	DESCRIPTION	LIST PRICE
Ice Chamber		
1602-1	7½Wx9½Dx17¾H	\$462.70 ea
1602-3	7½Wx9½Dx25¾H	498.20 ea
Infusion Chamber		
1602-1INF	7½Wx9½Dx17¾H	\$462.70 ea
1602-3INF	7½Wx9½Dx25¾H	498.20 ea



e Glacier Beverage Dispensers *New*

3 Gallon Capacity.
Specify Color: Clear Faux Glass (12),
Green Faux Glass (43).

ITEM	DESCRIPTION	LIST PRICE
Ice Chamber		
3437-3	7Wx9Dx26½H	\$486.60 ea
Infusion Chamber		
3437-3INF	7Wx9Dx26½H	486.60 ea

visit us online at: www.calmil.com **CAL·MIL** call toll-free 800-321-9069

Beverage Dispensers



Classic Rounded Acrylic Beverage Dispenser

3 Gallon Capacity. Includes Drip Tray and Ice Chamber.

ITEM	DESCRIPTION	LIST PRICE
1610	11Wx11Dx19H	\$245.80 ea



Classic Square Beverage Dispenser

1.5 and 3 Gallon Capacity. Powder Coated Metal Base. Includes Drip Tray and Chamber.

ITEM	DESCRIPTION	LIST PRICE
1112-1-13	7Wx9Dx19H - Glass	\$462.70 ea
1112-3-13	7Wx9Dx26½H - Glass	498.20 ea
1112-1A-13	7Wx9Dx19H - Acrylic	462.70 ea
1112-3A-13	7Wx9Dx26½H - Acrylic	498.20 ea



Write-On

Write-On Beverage Sign

Fits all Square Beverage Dispensers!

ITEM	DESCRIPTION	LIST PRICE
3059	3Wx5D	\$18.50 ea
3062-15	White Chalkboard Pen	12.40 ea



Econo ABS Beverage Dispenser

3 Gallon Capacity. Includes Ice Chamber.

ITEM	DESCRIPTION	LIST PRICE
JC201	9Wx13Dx22H	\$394.90 ea



Wire Base Acrylic Beverage Dispenser

Includes Ice Chamber.

ITEM	DESCRIPTION	LIST PRICE
JC302-13	8DIx17H - 1.5 Gallon	\$329.10 ea
JC301-13	8DIx26H - 3 Gallon	394.90 ea



Triangle Beverage Dispenser

4.2 Gallon Capacity. Includes Ice Chamber. Specify Color: Black (13), Platinum (39).

ITEM	DESCRIPTION	LIST PRICE
JC303	12Wx12Dx32H	\$438.80 ea



a Porcelain Beverage Dispenser *New*

Includes Drip Tray and Chalkboard Sign w/ Chain.
1.5 Gallon Capacity.

ITEM	DESCRIPTION	LIST PRICE
3460-1-13	10Wx10D18H	\$345.00 ea
3062-15	White Chalkboard Pen	12.40 ea

b Stainless Steel Beverage Dispenser *New*

ITEM	DESCRIPTION	LIST PRICE
3497-3BEV	14Wx14Dx11H - Dispenser Only	\$200.00 ea
3497-3-55	14Wx14Dx18H - Dispenser & Base	320.00 ea

c Beverage Dispenser Cart *New*

Cart Only. Beverage Dispensers Sold Separately.
Center Section of Cart Pulls Out for Easy Access.

ITEM	DESCRIPTION	LIST PRICE
3461-99	27Wx16Dx41H - Cart	\$1,200.00 ea

Beverage Dispensers

3554ICE	Clear 3 Gal. Dispenser - Ice	\$333.30 ea
3554INF	Clear 3 Gal. Dispenser - Infusion	333.30 ea
3460-1BEV	White Porcelain 1.5 Gal. Dispenser	220.00 ea

Accessories

3059	Square Dispenser Write-On Sign	\$18.50 ea
3454-1014-99	Reclaimed Wood Serving Tray	120.00 ea

d Classic Glass-Stacking Trays

Sold Individually, Not Sold as a Set.

ITEM	DESCRIPTION	LIST PRICE
353-13	15¼Wx12½Dx2H	\$37.90 ea

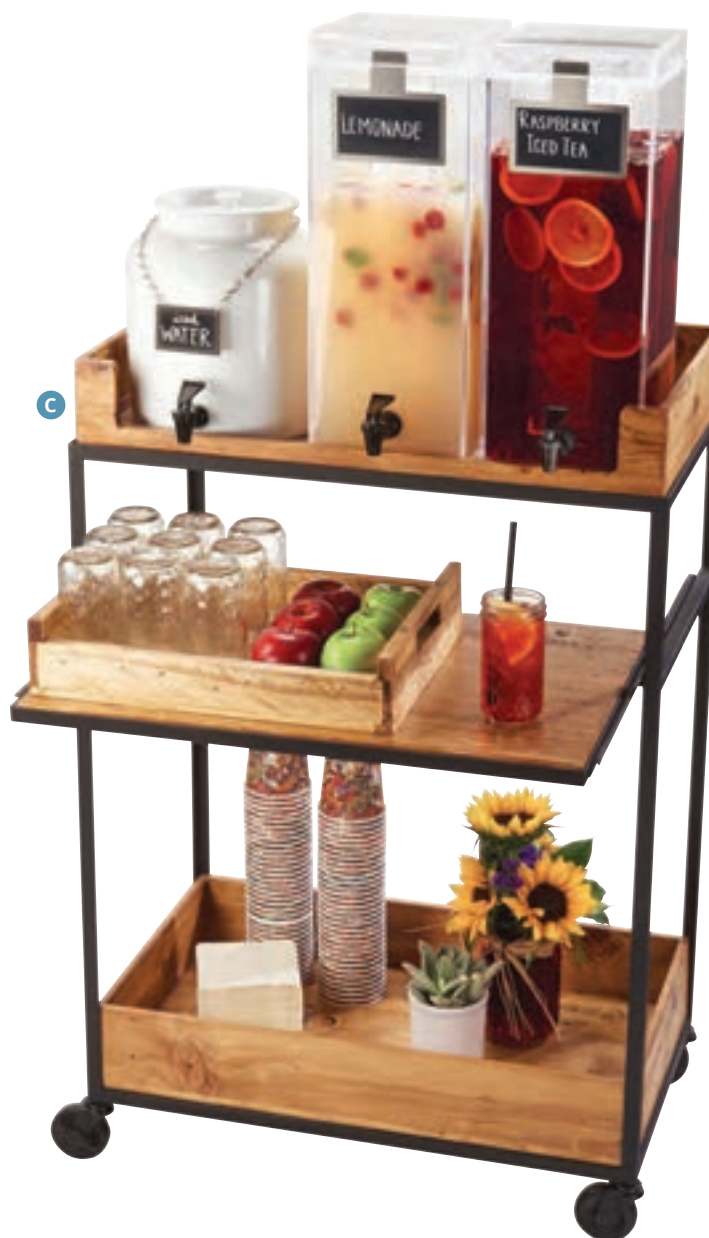

Pitchers & Drip Trays



682



682-ICE



682-INFUSION

Polycarbonate Pitchers

2 Liter Capacity, Polycarbonate.

ITEM	DESCRIPTION	LIST PRICE
682	9DIAx10H - Without Chamber	\$31.90 ea
682-ICE	9DIAx10H	31.90 ea
682-INFUSION	9DIAx10H	31.90 ea



Polycarbonate Pitcher *New*

1.5 Liter Capacity.
Stainless Steel Pour Spout.

ITEM	DESCRIPTION	LIST PRICE
3551-55	1.5 Liter	\$38.00 ea



Glass Pitcher with Ice Chamber BPA FREE

1/2 Gallon Capacity.
8" Diameter

ITEM	DESCRIPTION	LIST PRICE
JC100	8" Diameter	\$44.10 ea



Acrylic Pitcher with Ice and Infusion Chamber BPA FREE

3/4 Gallon Capacity.

ITEM	DESCRIPTION	LIST PRICE
JC102	11" Diameter	\$54.20 ea



Polycarbonate Carafe

1 Liter Capacity.

ITEM	DESCRIPTION	LIST PRICE
438	4Wx4Dx10H	\$12.90 ea



Classic Black Drip Trays

ITEM	DESCRIPTION	LIST PRICE
308-4-13	4Wx4Dx1H - Octagon	\$9.90 ea
308-6-13	6Wx6Dx1H - Octagon	11.20 ea
681-4-13	4Wx4Dx1H - Square	9.90 ea
681-6-13	6Wx4Dx1H - Square	11.20 ea



Bamboo

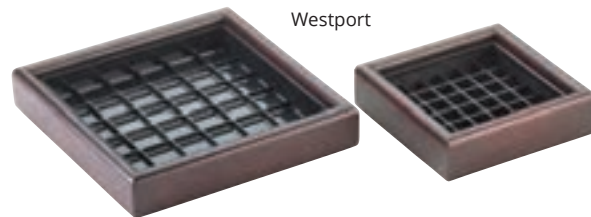

Westport



Madera

Drip Trays

Drip Trays are Removable for Cleaning. Specify Color: Westport (52), Bamboo (60), or Madera (99).

ITEM	DESCRIPTION	LIST PRICE
330-4	4Wx4Dx1H	\$39.90 ea
330-6	6Wx6Dx1H	50.00 ea

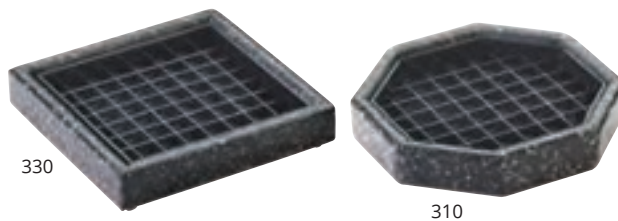

330

310

Stone Drip Trays

Drip Trays are Removable for Cleaning.

ITEM	DESCRIPTION	LIST PRICE
310-4-31	4Wx4Dx1H - Octagon	\$45.50 ea
310-6-31	6Wx6Dx1H - Octagon	59.30 ea
330-4-31	4Wx4Dx1H - Square	42.10 ea
330-6-31	6Wx6Dx1H - Square	57.90 ea



Chrome Drip Trays

ITEM	DESCRIPTION	LIST PRICE
308-4-49	4Wx4Dx1H	\$13.40 ea
308-6-49	6Wx6Dx1H	16.50 ea



Engraved Drip Trays

ITEM	DESCRIPTION	LIST PRICE
632-1	4Wx4Dx1H - Coffee	\$22.50 ea
632-2	4Wx4Dx1H - Decaf	22.50 ea
632-3	4Wx4Dx1H - Hot Water	22.50 ea



Drip Minder™

Drip Trays are Removable.

ITEM	DESCRIPTION	LIST PRICE
DM005	16¾Wx13Dx6½H	\$66.20 ea



Silver Trim Drip Trays

ITEM	DESCRIPTION	LIST PRICE
391-010	6Wx6Dx1H	\$22.50 ea
392-010	4Wx4Dx1H	18.30 ea

Cold Concept Systems

5 Base Styles To Choose From:



New
3367-99



3367-55



3367-15



3367-13



Cold Concept Porcelain Plate System

Complete Set Includes: Porcelain Plate/Bowl, Liner, and Cold Pack. Place Cold Pack in Freezer for a Minimum of 6 Hours. Keeps Contents Cold for 2-3 Hours. Bases Sold Separately.

ITEM	DESCRIPTION	LIST PRICE
3063	Porcelain Plate, Liner, Cold Pack	\$129.20 ea
3402	Hinged Dome Lid	56.70 ea

Cold Concept Bases

Keep Contents Cold for Hours! Cold Plates/Bowls Sold Separately. Dimensions: 12Wx12Dx4½H.

ITEM	DESCRIPTION	LIST PRICE
3367-13	Black Metal	\$164.80 ea
3367-15	White Metal	164.80 ea
3367-55	Urban Stainless Steel	164.80 ea
3367-60	Bamboo	123.60 ea
<i>New</i> 3367-99	Madera Reclaimed Wood	123.60 ea



3367-60



Stainless Steel Cold Concept Bowl
 Keep Gel-Filled Bowl in Freezer for Minimum of 6 Hours to Keep Contents Cold for Hours! Fits All Cold Concept Bases (Sold Separately).

ITEM	DESCRIPTION	LIST PRICE
3326-10-55	10Wx10Dx4H	\$139.30 ea
3402	Hinged Dome Lid	56.70 ea

Cold Concept Systems

No Ice? No Problem!
 Keeps Food Cold & Fresh For Hours!



5 Base Styles To Choose From – Page 104

Cold Concept Porcelain Bowl System
 Complete Set Includes: Porcelain Bowl, Liner, and Cold Pack. Place Cold Pack in Freezer for a Minimum of 6 Hours. Keeps Contents Cold for 2-3 Hours. Bases Sold Separately.

ITEM	DESCRIPTION	LIST PRICE
3064	Porcelain Bowl, Liner, Cold Pack	\$144.60 ea
3402	Hinged Dome Lid	56.70 ea



visit us online at: www.calmil.com **CAL·MIL** call toll-free 800-321-9069

Porcelain Displays



Prestige Porcelain 3 Tier Square Incline Display

Includes 3 Plates. Cold Concept Sold Separately.
Specify Color: Black (13), Platinum (39).

ITEM	DESCRIPTION	LIST PRICE
PP2301	16Wx26Dx22H	\$462.40 ea

Optional Cold Concept ❄️

Includes 1 Cold Pack and Liner. Place Cold Pack in Freezer for a Minimum of 6 Hours. Keeps Contents Cold for 2-3 Hours.

ITEM	DESCRIPTION	LIST PRICE
3065	Cold Pack and Liner	\$88.40 ea

❄️ Indicates Cold Concept Products



Prestige Porcelain 2 Tier Curved Metal Display

Includes 2 Bowls. Cold Concept Sold Separately.
Specify Color: Black (13), Platinum (39).

ITEM	DESCRIPTION	LIST PRICE
PP302	10Wx17Dx9H	\$303.30 ea
PP351	Replacement Bowl	56.20 ea

Optional Cold Concept ❄️

Includes 1 Cold Pack and Liner. Place Cold Pack in Freezer for Minimum of 6 Hours. Keeps Contents Cold for 2-3 Hours.

ITEM	DESCRIPTION	LIST PRICE
3066	Cold Pack and Bowl Liner	\$88.40 ea



Prestige Porcelain Square Pedestal Display

Includes 3 Platters. Cold Concept Sold Separately.

ITEM	DESCRIPTION	LIST PRICE
PP1600-13	34Wx16Dx9H	\$462.40 ea

Optional Cold Concept ❄️

Includes 1 Cold Pack and Liner. Place Cold Pack in Freezer for Up to 6 Hours. Keeps Contents Cold for 2-3 Hours.

ITEM	DESCRIPTION	LIST PRICE
3065	Cold Pack and Liner	\$88.40 ea



**Prestige Porcelain
3 Tier Bowl Display**

Includes 3 Bowls.
Specify Color: Black (13), Platinum (39).

ITEM	DESCRIPTION	LIST PRICE
PP703	24Wx24Dx13H	\$570.40 ea
PP750	Replacement Bowl	51.40 ea



Stainless Angled Plate Display

ITEM	DESCRIPTION	LIST PRICE
3361-55	27Wx13Dx15H	\$437.80 ea
PP650	Replacement Platter	50.80 ea



Porcelain Beverage Dispenser *New*

Includes Drip Tray and Chalkboard Sign w/ Chain. 1.5 Gallon Capacity.

ITEM	DESCRIPTION	LIST PRICE
3460-1-13	10Wx10D18H	\$345.00 ea
3062-15	White Chalkboard Pen	12.40 ea

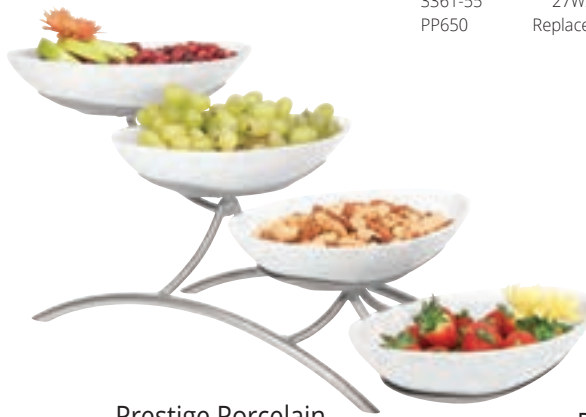

**Prestige Porcelain
4 Tier Display**

Includes 4 Bowls.
Specify Color: Black (13), Platinum (39).

ITEM	DESCRIPTION	LIST PRICE
PP2000	7Wx19Dx9H	\$346.40 ea
PP1151	Replacement Bowl	27.50 ea



**Prestige Porcelain
2 Tier Bowl Display**

Includes 2 Bowls.
Specify Color: Black (13), Platinum (39).

ITEM	DESCRIPTION	LIST PRICE
PP2100	16Wx20½Dx12¾H	\$482.00 ea
PP2150	Replacement Bowl	107.10 ea



Cold Concept Bases ❄️

Keep Contents Cold for Hours! Bases Only.
Cold Plates/Bowls Sold Separately.

ITEM	DESCRIPTION	LIST PRICE
3367-13	Black Metal	\$164.80 ea
3367-15	White Metal	164.80 ea
3367-55	Urban Stainless Steel	164.80 ea
3367-60	Bamboo	123.60 ea
3367-99	Madera Reclaimed Wood	123.60 ea



Cold Concept Set ❄️

Complete Set Includes: Porcelain Plate or Bowl, Liner, and Cold Pack. Place Cold Pack in Freezer for a Minimum of 6 Hours. Keeps Contents Cold for 2-3 Hours.

ITEM	DESCRIPTION	LIST PRICE
3063	Porcelain Plate, Liner, Cold Pack	\$129.20 ea
3064	Porcelain Bowl, Liner, Cold Pack	144.60 ea
3402	Hinged Dome Lid	56.70 ea

Porcelain Displays



a Prestige Porcelain Wide Frame 3 Tier Display

Includes 3 Platters.
Specify Color: Black (13), Platinum (39).

ITEM	DESCRIPTION	LIST PRICE
PP1033	23Wx18Dx12H	\$493.40 ea
PP152	Replacement Platter	94.90 ea

b Prestige Porcelain 3 Tier Platter Display

Includes 3 Platters.
Specify Color: Black (13), Platinum (39).

ITEM	DESCRIPTION	LIST PRICE
PP103	22Wx12Dx12H	\$462.40 ea

Replacement Platters

PP150	Small Replacement Platter	51.80 ea
PP151	Medium Replacement Platter	76.10 ea
PP152	Large Replacement Platter	94.90 ea

c Prestige Porcelain 3 Tier Straight Platter Display

Includes 3 Platters.
Specify Color: Black (13), Platinum (39).

ITEM	DESCRIPTION	LIST PRICE
PP2200	23Wx13Dx10H	\$493.40 ea
PP551	Replacement Platter	107.10 ea

d Prestige Porcelain 3 Tier Square Display

Includes 1 Tray and 2 Bowls.
Specify Color: Black (13), Platinum (39).

ITEM	DESCRIPTION	LIST PRICE
PP203	14Wx15Dx15H	\$361.80 ea

Replacement Platters

PP250	Small Replacement Bowl	23.20 ea
PP251	Medium Replacement Bowl	27.50 ea
PP252	Replacement Platter	40.80 ea



Porcelain Long Platters

ITEM	DESCRIPTION	LIST PRICE
PP150	18Wx3Dx1H	\$51.80 ea
PP151	20Wx5Dx1H	76.10 ea
PP152	23Wx7Dx1H	94.90 ea



Porcelain Flat Platters *New*

ITEM	DESCRIPTION	LIST PRICE
3469-156-15	15Wx6Dx1½H	\$32.00 ea
3469-206-15	20Wx6Dx1½H	50.00 ea
3469-2010-15	20Wx10Dx1½H	78.00 ea



Porcelain Long Oval Platter

ITEM	DESCRIPTION	LIST PRICE
PP551	24Wx8Dx1H	\$107.10 ea



Porcelain Small Round Bowl

ITEM	DESCRIPTION	LIST PRICE
PP1153	4DIAx2¼H	\$18.70 ea

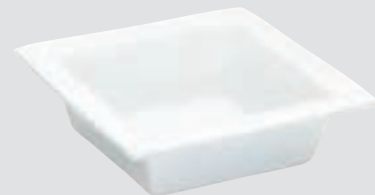

Porcelain Wide Edge Square Bowl

ITEM	DESCRIPTION	LIST PRICE
PP351	10Wx10Dx3H	\$56.20 ea

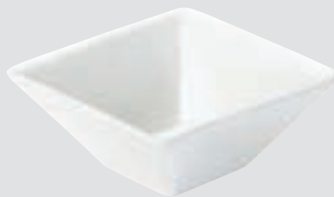

Porcelain Deep Bowl

ITEM	DESCRIPTION	LIST PRICE
PP250	7Wx7Dx3H	\$23.20 ea

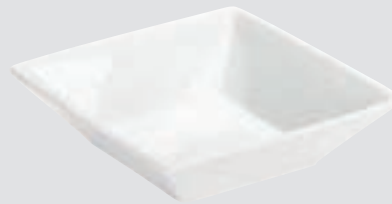

Porcelain Medium Square Bowl

ITEM	DESCRIPTION	LIST PRICE
PP251	8Wx8Dx2H	\$27.50 ea

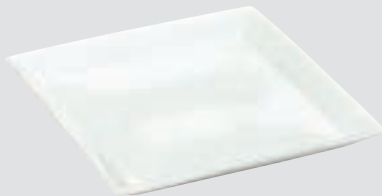

Porcelain Large Square Platter

ITEM	DESCRIPTION	LIST PRICE
PP252	11Wx11Dx1H	\$40.80 ea



Porcelain Oval Bowl

ITEM	DESCRIPTION	LIST PRICE
PP2150	16Wx12Dx5H	\$107.10 ea



Porcelain Round Platter

ITEM	DESCRIPTION	LIST PRICE
PP1167	12¾DIAx1½H	\$38.50 ea



Porcelain Round Platter

ITEM	DESCRIPTION	LIST PRICE
PP750	12½DIAx3H	\$51.40 ea



Porcelain Shark Platter

ITEM	DESCRIPTION	LIST PRICE
PP650	13Wx10Dx1H	\$50.80 ea



Porcelain Canoe Bowl

ITEM	DESCRIPTION	LIST PRICE
PP1151	11Wx5Dx2H	\$27.50 ea

Melamine Displays



Melamine Square 2 Tier Display

Includes 3 Platters. Cold Concept Sold Separately. Specify Color: Black (13), Platinum (39).

ITEM	DESCRIPTION	LIST PRICE
SR1600	16Wx31Dx9H	\$299.90 ea

Optional Cold Concept ❄️

Includes 1 Cold Pack and Liner. Place Cold Pack in Freezer for Minimum of 6 Hours. Keeps Contents Cold for 2-3 Hours.

ITEM	DESCRIPTION	LIST PRICE
3065	Cold Pack and Liner	\$88.40 ea



Melamine Offset 3 Tier Square Display

Includes 3 Plates. Specify Color: Black (13), Platinum (39).

ITEM	DESCRIPTION	LIST PRICE
SR2301	16Wx22Dx26H	\$299.90 ea

Optional Cold Concept ❄️

Includes 1 Cold Pack and Liner. Place Cold Pack in Freezer for Minimum of 6 Hours. Keeps Contents Cold for 2-3 Hours.

ITEM	DESCRIPTION	LIST PRICE
3065	Cold Pack and Liner	\$88.40 ea



Whipped Cream Cooler

Includes 4 Stackable Cold Packs. Keep Cold Packs in Freezer for Minimum of 6 Hours to Keep Contents Chilled for Hours!

ITEM	DESCRIPTION	LIST PRICE
3399	5Wx5Dx4¾H	\$56.70 ea



32 oz. Melamine Cold Jar

Includes 1 Cold Puck. Keep Cold Pack in Freezer for Minimum of 6 Hours to Keep Contents Chilled for Hours!

ITEM	DESCRIPTION	LIST PRICE
3050-32	5DIx5½H	\$36.70 ea

Clear Covers for Platters



ITEM	DESCRIPTION	LIST PRICE
DM252	12Wx12Dx2H	\$62.10 ea



a Black Long Platter Display

Includes 3 Melamine Platters.

ITEM	DESCRIPTION	LIST PRICE
SR1520-13	24Wx14Dx9H	\$321.40 ea
SR152	Replacement Platter	67.30 ea



b Melamine 3 Tier Incline Display

Includes 3 Platters.

Specify Color: Black (13), Platinum (39).

ITEM	DESCRIPTION	LIST PRICE
SR1033	18Wx23Dx12H	\$321.40 ea
SR152	Replacement Platter	67.30 ea



c Melamine 3 Tier Bowl Display

Includes 3 Bowls.

Specify Color: Black (13), Platinum (39).

ITEM	DESCRIPTION	LIST PRICE
SR701	21Wx18Dx19H	\$299.90 ea
SR750	Replacement Bowl	53.60 ea



d Melamine 3 Tier Oval Platter Display

Includes 3 Oval Platters.

Specify Color: Black (13), Platinum (39).

ITEM	DESCRIPTION	LIST PRICE
SR900	15Wx29Dx12H	\$321.40 ea
SR950	Replacement Platter	42.80 ea



e Melamine Arch Bowl Display

Includes 3 Melamine Bowls.

ITEM	DESCRIPTION	LIST PRICE
SR2020-13	9Wx27Dx7H	\$235.70 ea
SR261	Replacement Bowl	32.10 ea

f Multi-Level Melamine Bowl Displays

Includes Melamine Bowls (Specify Round or Square).
Stainless Steel (55).

ITEM	DESCRIPTION	LIST PRICE
3320-5-55	28Wx10Dx5½H - Round Bowls	\$278.50 ea
3320-9-55	28Wx10Dx9½H - Round Bowls	321.40 ea
3322-5-55	28Wx10Dx5½H - Square Bowls	278.50 ea
3322-9-55	28Wx10Dx9½H - Square Bowls	321.40 ea

Replacement Bowls

418-8-15	8" Round Melamine Bowl	\$33.00 ea
SR261	8" Square Melamine Bowl	32.10 ea



Melamine Displays



Melamine 4 Tier Large Canoe Display

Includes 4 Large Canoe Bowls.
Specify Color: Black (13), Platinum (39).

ITEM	DESCRIPTION	LIST PRICE
SR302	17Wx32Dx12H	\$342.80 ea
SR351	Replacement Canoe	46.00 ea



Union Square Bowl Display

Includes 3 Bowls.

ITEM	DESCRIPTION	LIST PRICE
3404-13	6½Wx19Dx12H	\$257.50 ea
SR261	Replacement Bowl	32.10 ea



Melamine 5 Tier Small Canoe Display

Includes 5 Small Canoe Bowls.
Specify Color: Black (13), Platinum (39).

ITEM	DESCRIPTION	LIST PRICE
SR303	29Wx13Dx16H	\$321.40 ea
SR350	Replacement Canoe	40.70 ea



Melamine 4 Tier Bowl and Canoe Display

Includes 3 Small Canoe Bowls and 1 Large Bowl.
Specify Color: Black (13), Platinum (39).

ITEM	DESCRIPTION	LIST PRICE
SR801	17Wx27Dx11H	\$364.20 ea
SR852	Replacement Bowl	64.30 ea
SR350	Replacement Canoe	40.70 ea



Melamine 3 Tier Canoe Display

Includes 3 Melamine Large Canoe Bowls.
Specify Color: Black (13), Platinum (39).

ITEM	DESCRIPTION	LIST PRICE
SR304	16½Wx18½Dx10½H	\$235.70 ea
SR351	Replacement Canoe	46.00 ea





a Melamine 2 Tier Bowl Display

Includes 3 Melamine Bowls.

ITEM	DESCRIPTION	LIST PRICE
SR2030-13	9Wx25Dx11H	\$299.90 ea
SR262	Replacement Bowl	42.90 ea



b Melamine 4 Bowl Square Display

Includes Melamine Bowls and Platter.

ITEM	DESCRIPTION	LIST PRICE
SR1010-13	19Wx19Dx11H	\$235.70 ea
SR261	Small Replacement Bowl	32.10 ea
SR263	Large Replacement Bowl	53.60 ea



c Faux Slate Bowl Display *New*

Includes 3 Bowls.

ITEM	DESCRIPTION	LIST PRICE
3456-13	17½Wx14Dx8H	\$235.70 ea

Replacement Bowls

3498-5-65M	5Wx5Dx3H	\$15.00 ea
3498-8-65M	8Wx8Dx3¾H	32.10 ea
3498-10-65M	9½Wx9½Dx4H	42.90 ea



d Melamine 3 Tier Bowl Display

Includes 3 Bowls.

Specify Color: Black (13), Platinum (39).

ITEM	DESCRIPTION	LIST PRICE
SR402	12Wx24Dx14H	\$299.90 ea
SR549	Replacement Bowl	48.20 ea

e Melamine 3 Tier Square Bowl Display

Includes 3 Square Melamine Bowls.

ITEM	DESCRIPTION	LIST PRICE
SR307-13	10½Wx16Dx14H	\$257.10 ea
SR261	Replacement Bowl	32.10 ea

f Melamine Platter and Square Bowl Display

Includes Melamine Bowls and Platter.

ITEM	DESCRIPTION	LIST PRICE
SR1020-13	19½Wx19½Dx11H	\$299.90 ea
SR252	Replacement Platter	37.50 ea
SR261	Replacement Bowl	32.10 ea



Melamine Platters & Bowls



Melamine Long Platter

ITEM	DESCRIPTION	LIST PRICE
SR152	23Wx7Dx1H	\$67.30 ea



Melamine Large Square Platter

ITEM	DESCRIPTION	LIST PRICE
SR252	11 ³ / ₄ Wx11 ³ / ₄ Dx1H	\$37.50 ea



Melamine Shallow Square Bowl

ITEM	DESCRIPTION	LIST PRICE
1707-10-15	10Wx10Dx3H	\$77.60 ea



Melamine Large Oval Bowl

ITEM	DESCRIPTION	LIST PRICE
SR950	12Wx15Dx2H	\$42.80 ea



Melamine Canoe Bowl

ITEM	DESCRIPTION	LIST PRICE
SR350	12Wx4Dx2H	\$40.70 ea
SR351	16Wx6Dx3H	46.00 ea



Melamine Extended Base Round Bowl

ITEM	DESCRIPTION	LIST PRICE
SR750	10Wx11Dx6H	\$53.60 ea

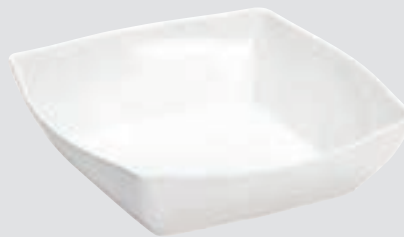

Melamine Rounded Square Bowl

ITEM	DESCRIPTION	LIST PRICE
SR150	13Wx13Dx4H	\$58.90 ea



Melamine Triangle Bowl

ITEM	DESCRIPTION	LIST PRICE
SR549	10Wx10Dx4H	\$48.20 ea



Melamine Multi Size Round Bowls

ITEM	DESCRIPTION	LIST PRICE
SR850	11DIAx4H	\$48.20 ea
SR851	13DIAx5H	58.90 ea
SR852	15DIAx6H	64.30 ea



Melamine Square Bowls

ITEM	DESCRIPTION	LIST PRICE
SR261	8Wx8Dx5H	\$32.10.ea
SR262	10Wx10Dx5H	42.90 ea
SR263	12Wx12Dx5H	53.60 ea



Faux Slate Bowls *New*

Black Slate Melamine (65M).

ITEM	DESCRIPTION	LIST PRICE
3498-5-65M	5Wx5Dx3H	\$15.00 ea
3498-8-65M	8Wx8Dx3¾H	32.10 ea
3498-10-65M	9½Wx9½Dx4H	42.90 ea



Melamine Square/Round Bowls

Specify Color: Black (13), White (15), Butter Yellow (61), Terra Cotta (62), Sage (63), or Cranberry (64).

ITEM	DESCRIPTION	LIST PRICE
418-6	6" Round Bowl	\$22.20 ea
418-8	8" Round Bowl	33.00 ea
418-10	10" Round Bowl	55.70 ea
1707-10	10" Square Bowl	77.60 ea



Melamine Ramekins *New*

Specify Color: Black (13) or White (15).

ITEM	DESCRIPTION	LIST PRICE
3484	2¾DIAx1½H	\$2.50 ea



Diamond Melamine Bowl

ITEM	DESCRIPTION	LIST PRICE
3342-8-15	8DIAx3¾H	\$33.00 ea
3342-11-15	11DIAx4¾H	55.70 ea



White and Black Round Jars

Round Write On

Melamine Round Jars

Write-On Label is Commercial Grade, Scratch and Dent Proof!

ITEM	DESCRIPTION	LIST PRICE
------	-------------	------------

White and Black Jars

Specify Color: Black (13), White (15).

1950-16	4DIAx4¾H - 16 oz.	\$18.80 ea
1950-32	5DIAx5½H - 32 oz.	25.30 ea
1950-64	6¾DIAx6¾H - 64 oz.	34.20 ea

Write-On

1950-16-15C	4DIAx4¾H - 16 oz.	\$22.50 ea
1950-32-15C	5DIAx5½H - 32 oz.	28.90 ea
1950-64-15C	6¾DIAx6¾H - 64 oz.	38.00 ea



Square White Only

Square Write On

Melamine Square Jars

ITEM	DESCRIPTION	LIST PRICE
------	-------------	------------

Square White Only

C1432BODY	4Wx4Dx4H - Jar Only	\$14.80 ea
1432-15	4Wx4Dx4H - w/ Full Lid	22.90 ea
1335-15	5Wx5Dx5H - w/ Full Lid	28.30 ea
1335-15N	5Wx5Dx5H - w/ Notched Lid	28.30 ea
1336-15	4Wx8Dx4H - w/ Full Lid	28.30 ea
1336-15N	4Wx8Dx4H - w/ Notched Lid	28.30 ea

Square Write-On

C1432BODYC	4Wx4Dx4H - Jar Only	\$18.30 ea
1432-15C	4Wx4Dx4H - w/ Full Lid	26.20 ea
1432-15N-C	4Wx4Dx4H - w/ Notched Lid	26.20 ea

Melamine Platters & Bowls



Melamine Enamelware Deep Trays *New*

All 4 Sizes Create Complete Square.

ITEM	DESCRIPTION	LIST PRICE
3466-15	10Wx10Dx2H	\$36.00 ea
3470-15	12Wx7Dx2H	33.00 ea
3464-15	12Wx10Dx2H	36.00 ea
3465-15	15Wx12Dx2H	50.00 ea



Melamine Enamelware Small Bowls *New*

ITEM	DESCRIPTION	LIST PRICE
3467-4-15	4½DIAx1¼H	\$6.00 ea
3467-5-15	5½DIAx2H	12.00 ea



Melamine Enamelware Chip/Fry Holder *New*

ITEM	DESCRIPTION	LIST PRICE
3462-15	3½DIAx5H	\$9.00 ea



Melamine Enamelware Serving Tray *New*

ITEM	DESCRIPTION	LIST PRICE
3463-15	13Wx9Dx1H - Tray	\$25.00 ea
3467-4-15	4½DIAx2H - Bowl	6.00 ea
3479-55	Stainless 2-3 Taco Holder	16.00 ea



3343-10-15

Melamine Enamelware Bowls

ITEM	DESCRIPTION	LIST PRICE
3343-8-15	8¼DIAx3¾H	\$33.00 ea
3343-10-15	10¾DIAx5H	55.70 ea



3343-8-15



P311

P302

P313

Cake/Pie Covers

ITEM	DESCRIPTION	LIST PRICE
P313	12DIAx4H	\$31.40 ea
P302	12DIAx6H	30.20 ea
P311	12DIAx9H	44.60 ea



P308

P306

Cake/Pie Trays & Pedestals

ITEM	DESCRIPTION	LIST PRICE
P306	12DIAx1H	\$28.00 ea
P308	12DIAx5H	60.50 ea

Stainless Steel Cake Stand

ITEM	DESCRIPTION	LIST PRICE
1308	12DIAx7H	\$31.50 ea

visit us online at: www.calmil.com **CAL·MIL** call toll-free 800-321-9069

Covers & Trays



Turn N Serve®
Clear Gourmet Cover

ITEM	DESCRIPTION	LIST PRICE
301-10	10DIAx4½H	\$65.30 ea
301-12	12DIAx5½H	84.30 ea
301-15	15DIAx7H	115.80 ea
301-18	18DIAx8H	173.80 ea



302



303

Turn N Serve®
Clear Colonial Cover

ITEM	DESCRIPTION	LIST PRICE
302-10	10DIAx4½H	\$91.70 ea
302-12	12DIAx5¾H	107.60 ea
302-15	15DIAx7H	141.60 ea

Turn N Serve®
Clear Continental Cover

ITEM	DESCRIPTION	LIST PRICE
303-12	12DIAx3¾H	\$107.60 ea
303-15	15DIAx3¾H	141.60 ea



Shallow Tray

Deep Tray

Turn N Serve®
Shallow Tray

Specify Color: Clear (12) or Black (13).

ITEM	DESCRIPTION	LIST PRICE
315-10	10DIAx1H	\$25.50 ea
315-12	12DIAx1H	31.00 ea
315-15	15DIAx1H	39.10 ea
315-18-12	18DIAx1H	45.50 ea

Turn N Serve®
Clear Deep Tray

Clear (12), Black (13).

ITEM	DESCRIPTION	LIST PRICE
316-10-12	10DIAx2½H	\$27.00 ea
316-12-12	12DIAx3½H	44.60 ea
316-12-13	12DIAx3½H	51.60 ea
316-15	15DIAx3½H - Clear	51.70 ea
316-18	18DIAx3½H - Clear	64.70 ea

a Lift & Serve Clear Gourmet Cover

ITEM	DESCRIPTION	LIST PRICE
150-10	10DIAx6H	\$46.80 ea
150-12	12DIAx7H	62.30 ea
150-15	15DIAx9H	84.00 ea



b Colonial Clear Covers

ITEM	DESCRIPTION	LIST PRICE
312-10	10DIAx5½H	\$37.90 ea
312-12	12DIAx6H	46.80 ea
312-15	15DIAx7H	73.20 ea
312-18	18DIAx7H	93.10 ea



c Gourmet Clear Covers

ITEM	DESCRIPTION	LIST PRICE
311-7	7DIAx4H	\$24.80 ea
311-9	9DIAx5H	30.10 ea
311-10	11¼DIAx6½H	35.00 ea
311-12	12DIAx7H	44.60 ea
311-15	15DIAx9H	69.80 ea
311-18	18DIAx10H	80.20 ea



d Black Cone Pedestals

ITEM	DESCRIPTION	LIST PRICE
482-12-13	12DIAx5H	\$60.50 ea
482-15-13	15DIAx5H	64.60 ea



e Shallow Trays

Specify Color: Clear (12) or Black (13).

ITEM	DESCRIPTION	LIST PRICE
315-10	10DIAx1H	\$25.50 ea
315-12	12DIAx1H	31.00 ea
315-15	15DIAx1H	39.10 ea
315-18-12	18DIAx1H - Clear	45.50 ea



f Clear Deep Trays

ITEM	DESCRIPTION	LIST PRICE
316-10-12	10DIAx2½H	\$27.00 ea
316-12-12	12DIAx3½H	44.60 ea
316-15	15DIAx3½H	51.70 ea
316-18	18DIAx3½H	64.70 ea



g Gold Trim Pedestal

ITEM	DESCRIPTION	LIST PRICE
319-12B7	12Wx12Dx7H	\$77.70 ea



h Round Chill Sampler

Complete Set Includes Cold Pack, Plate, and Liner! Stainless Steel (55).

ITEM	DESCRIPTION	LIST PRICE
3328-12-55	12DIAx7½H	\$230.40 ea



i Square Chill Sampler

Complete Set Includes Cold Pack, Plate, and Liner! Stainless Steel (55).

ITEM	DESCRIPTION	LIST PRICE
3329-12-55	12Wx13Dx7½H	\$230.40 ea



Covers & Trays



Standard Cover w/Long Hinge

ITEM	DESCRIPTION	LIST PRICE
329-12	12Wx20Dx4H	\$86.00 ea
329-13	13Wx18Dx4H	91.20 ea
329-18	18Wx26Dx4H	101.70 ea



Standard Covers

ITEM	DESCRIPTION	LIST PRICE
327-9	9Wx26Dx4H	\$59.00 ea
327-12	12Wx20Dx4H	64.80 ea
327-13	13Wx18Dx4H	68.20 ea
327-18	18Wx26Dx4H	85.90 ea
333-10	10Wx14Dx4H	60.50 ea



Standard Cover w/Center Hinge

ITEM	DESCRIPTION	LIST PRICE
328-12	12Wx20Dx4H	\$86.70 ea
328-13	13Wx18Dx4H	91.20 ea
328-18	18Wx26Dx4H	100.50 ea
334-12	12Wx18Dx4H	82.10 ea



Standard Cover w/Door

ITEM	DESCRIPTION	LIST PRICE
362-12	12Wx20Dx4H	\$102.40 ea



Stainless Steel Accent Cover w/Hinge

ITEM	DESCRIPTION	LIST PRICE
1526-55	12Wx20Dx2¾H	\$128.00 ea

Shallow Trays

ITEM	DESCRIPTION	CLEAR (12) LIST PRICE	BLACK (13) LIST PRICE	WHITE (15) LIST PRICE
325-9	9Wx26Dx1H	\$40.10 ea	N/A	N/A
325-10	10Wx12Dx1H	31.00 ea	37.10 ea	N/A
325-12	12Wx20Dx1H	61.20 ea	67.50 ea	67.50 ea
325-13	13Wx18Dx1H	36.50 ea	42.20 ea	42.20 ea
325-18	18Wx26Dx1H	86.30 ea	128.40 ea	N/A
335-10	10Wx14Dx1H	32.50 ea	39.00 ea	N/A
335-12	12Wx18Dx1H	49.50 ea	N/A	N/A

Slimline Clear Shallow Tray

ITEM	DESCRIPTION	LIST PRICE
P232-12	12Wx20Dx1H	\$44.90 ea
P235-12	18Wx26Dx1H	55.10 ea

Clear Deep Tray

ITEM	DESCRIPTION	LIST PRICE
336-12	12Wx18Dx2¾H	\$60.50 ea



Clear Chafer Cover w/ Flip Lid

ITEM	DESCRIPTION	LIST PRICE
1375	12Wx20Dx5½H	\$86.00 ea



Dome Cover w/ 2 End Cuts

ITEM	DESCRIPTION	LIST PRICE
323-12	12Wx20Dx7½H	\$81.80 ea



Dome Covers

ITEM	DESCRIPTION	LIST PRICE
321-10	10Wx12Dx4½H	\$50.90 ea
321-12	12Wx20Dx7½H	64.80 ea
321-13	13Wx18Dx5½H	72.30 ea
321-18	18Wx26Dx8H	89.10 ea



Dome Cover w/ End Door

ITEM	DESCRIPTION	LIST PRICE
339-12	12Wx20Dx7H	\$102.40 ea



Dome Covers w/ Side Cut

ITEM	DESCRIPTION	LIST PRICE
324-10	10Wx12Dx4½H	\$55.50 ea
324-12	12Wx20Dx7½H	79.70 ea
324-18	18Wx26Dx8H	100.50 ea



Dome Covers w/ End Cut

ITEM	DESCRIPTION	LIST PRICE
322-10	10Wx12Dx4½H	\$55.30 ea
322-12	12Wx20Dx7½H	79.70 ea
322-18	18Wx26Dx8H	99.70 ea



Plastic Roll Top Cover

ITEM	DESCRIPTION	LIST PRICE
1703	21Wx13Dx7H	\$55.50 ea



Dome Cover w/ Dual Doors

ITEM	DESCRIPTION	LIST PRICE
361-12	12Wx20Dx7H	\$119.90 ea



Euro Covers

ITEM	DESCRIPTION	LIST PRICE
332-12	12Wx18Dx6H	\$77.70 ea



Dome Cover w/ Front Door

ITEM	DESCRIPTION	LIST PRICE
367-10	10Wx12Dx4½H	\$78.80 ea
367-12	12Wx20Dx7H	102.40 ea

Chafers & Alternatives



Madera Chafers Alternatives New

Reclaimed Wood (99).

ITEM	DESCRIPTION	LIST PRICE
3440-99	10Wx10Dx5½H	\$220.00 ea
3439-99	20Wx10Dx5¾H	300.00 ea



Soho Chafers Alternatives

Specify Color: Black (13), Silver (74).

ITEM	DESCRIPTION	LIST PRICE
3365-12	12Wx12Dx5H	\$196.70 ea
3403-12	12Wx12Dx7½H	201.90 ea
3365-22	22Wx12Dx5H	309.00 ea

Luxe Chafers Alternatives

Stainless Steel (55).

ITEM	DESCRIPTION	LIST PRICE
3011-55	12Wx12Dx8¾H	\$204.60 ea
3012-55	22Wx12Dx8¾H	284.10 ea



Urban Chafers Alternatives

Stainless Steel (55).

ITEM	DESCRIPTION	LIST PRICE
3407-55	12Wx12Dx8¾H	\$204.60 ea
3391-55	22Wx7½Dx8¾H	283.30 ea



Iron Chafers Alternatives New

ITEM	DESCRIPTION	LIST PRICE
1361-12	12Wx12Dx7½H	\$184.40 ea
1361-22	22Wx12Dx7½H	319.50 ea

a Mission Chafers Alternatives

Griddle Sold Separately (Works Only with 1360-22-13 and 1364-22-13).

ITEM	DESCRIPTION	LIST PRICE
1360-12-13	12Wx12Dx7½H	\$210.70 ea
1364-12-13	12Wx12Dx4H	210.70 ea
1360-22-13	22Wx12Dx7½H	344.20 ea
1364-22-13	22Wx12Dx4H	344.20 ea
1362	Optional Griddle	123.00 ea



b Squared Chafers Alternatives

Specify Color: Black (13), Stainless Steel (55).

ITEM	DESCRIPTION	LIST PRICE
1612-12-13	12Wx12Dx7½H	\$204.60 ea
1612-12-55	12Wx12Dx7½H	272.70 ea
1612-22-13	23Wx15Dx7½H	284.10 ea
1612-22-55	23Wx15Dx7½H	329.60 ea

c One by One Chafers Alternatives

ITEM	DESCRIPTION	LIST PRICE
1348-12-13	12Wx12Dx4H	\$187.40 ea
1409-12-13	12Wx12Dx7H	187.40 ea
1348-22-13	22Wx12Dx4H	304.40 ea
1409-22-13	22Wx12Dx7H	304.40 ea



d Griddle Option with Brackets

ITEM	DESCRIPTION	LIST PRICE
1362	22¾Wx13¾Dx1¼H	\$123.00 ea

e Griddle w/ Heat Guard Handles

ITEM	DESCRIPTION	LIST PRICE
3067	22¾Wx13¾Dx1¼H	\$123.00 ea



Chafers & Alternatives



Stainless Steel Grill System *New*

Grill Includes Grate Only. Double Sided Griddle and Flat Pizza Pan Sold Separately. Use with Canned Chafer Fuel.

ITEM	DESCRIPTION	LIST PRICE
3451-55	23Wx12¼Dx7H	\$350.00 ea

Grill Options

3451-55FLAT	Aluminum Teflon Coated Griddle	\$48.00 ea
3451-55GRIDDLE	Double Sided Cast Iron Griddle	60.00 ea



Iron Action Station *New*

Griddles Sold Separately.

ITEM	DESCRIPTION	LIST PRICE
3457-13	23¼Wx14Dx6H	\$90.00 ea
3458-13	22½Wx22½Dx6H	120.00 ea

Classic Chafer Alternative

Made with Built in Wind guard and Securely Holds up to 12" Diameter Pans.

ITEM	DESCRIPTION	LIST PRICE
1344-7-13	12¾DIAx7¼H	\$198.60 ea
1344-10-13	12¾DIAx10H	198.60 ea



1286-18-13



1286-12-13

One by One Action Stations

Griddle Sold Separately.

ITEM	DESCRIPTION	LIST PRICE
Square		
1286-18-13	18¼Wx17¼Dx4½H	\$210.70 ea
1461	Optional Griddle	234.10 ea
3068	Optional Griddle w/ Heat Guard Handles	234.10 ea
Rectangle		
1286-12-13	18Wx9Dx5H	\$187.40 ea
1362	Optional Griddle	123.00 ea
3067	Optional Griddle w/ Heat Guard Handles	123.00 ea



Griddle w/ Heat Guard Handle

ITEM	DESCRIPTION	LIST PRICE
3067	22¾Wx13¾Dx1¼H	\$123.00 ea
3068	23Wx23Dx1¼H	234.10 ea



Griddle Option with Brackets

ITEM	DESCRIPTION	LIST PRICE
1362	22¾WX13¾DX1¼H	\$123.00 ea
1461	23Wx23Dx1¼H	234.10 ea

a Mission Butane Stove Frame

Iwatani Model 35FW Not Included.

ITEM	DESCRIPTION	LIST PRICE
1363-13	14Wx12Dx7H	\$224.80 ea



b Mission Induction Frame

Induction Unit Not Included.

1414-S Fits Spring SR-261C.

1414-V Fits Volrath 59500.

ITEM	DESCRIPTION	LIST PRICE
1414-S-13	13¾Wx16½Dx7H	\$210.70 ea
1414-V-13	14¾Wx16½Dx7H	234.10 ea



c Madera Butane Stove Frame *New*

Iwatani Model 35FW Not Included.

Reclaimed Wood (99).

ITEM	DESCRIPTION	LIST PRICE
3435-99	12¾Wx14¾Dx6½H	\$236.00 ea



d Soho Butane Stove Frame

Iwatani Model 35FW Not Included.

Specify Color: Black (13), Silver (74).

ITEM	DESCRIPTION	LIST PRICE
1576	14Wx13¾Dx7¼H	\$176.50 ea



e Squared Butane Stove Frame

Iwatani Model 35FW Not Included.

Black (13), Stainless Steel (55).

ITEM	DESCRIPTION	LIST PRICE
1617-13	13Wx11Dx6H	\$227.30 ea
1617-55	13Wx11Dx6H	272.70 ea

f Luxe Butane Stove Frame

Iwatani Model 35FW Not Included.

Stainless Steel (55).

ITEM	DESCRIPTION	LIST PRICE
3023-55	12Wx14¾Dx7½H	\$227.30 ea

g Urban Butane Stove Frame

Iwatani Model 35FW Not Included.

Stainless Steel (55).

ITEM	DESCRIPTION	LIST PRICE
3390-55	14Wx12½Dx7¼H	\$227.30 ea

h Westport Butane Stove Frame

Iwatani Model 35FW Not Included.

ITEM	DESCRIPTION	LIST PRICE
1556-52	14Wx14½Dx7½H	\$220.60 ea



Chafers & Alternatives

Note: Chafer Covers Are Not Warranted For Steam Table Use.

Caution: Handle Can Get Extremely Hot. Do Not Expose To Direct Flame.



Stainless Steel Chafer Cover

ITEM	DESCRIPTION	LIST PRICE
3325-55	21Wx13Dx2½H	\$299.90 ea



Plastic Roll Top Cover

ITEM	DESCRIPTION	LIST PRICE
1703	21Wx13Dx7H	\$55.50 ea



Stainless Steel Accent Cover

ITEM	DESCRIPTION	LIST PRICE
1526-55	21½Wx13¼Dx2¾H	\$128.00 ea



Clear Chafer Covers w/Door

ITEM	DESCRIPTION	LIST PRICE
367-10	10Wx12Dx4½H	\$78.80 ea
367-12	12Wx20Dx7H	102.40 ea



Clear Chafer Cover w/ Flip Lid

ITEM	DESCRIPTION	LIST PRICE
1375	21¼Wx13½Dx5½H	\$86.00 ea



Clear Chafer Cover w/Door

ITEM	DESCRIPTION	LIST PRICE
339-12	12Wx20Dx7H	\$102.40 ea



Chafer Cover w/ Dual Doors

ITEM	DESCRIPTION	LIST PRICE
361-12	12Wx20Dx7H	\$119.90 ea



Chafer Covers w/ Cutout

ITEM	DESCRIPTION	LIST PRICE
324-10	10Wx12Dx4½H	\$55.50 ea
324-12	12Wx20Dx7½H	79.70 ea



Chafer Cover w/ Dual Cutouts

ITEM	DESCRIPTION	LIST PRICE
323-12	12Wx20Dx7½H	\$81.80 ea



Clear Chafer Covers w/Cutout

ITEM	DESCRIPTION	LIST PRICE
322-10	10Wx12Dx4½H	\$55.30 ea
322-12	12Wx20Dx7½H	79.70 ea



Clear 3-Sided Chafer Windguard

Cal-Mil Chafers Have Built-in Windguards, Only Standard Chafers Need These Windguards.

ITEM	DESCRIPTION	LIST PRICE
978-12	22½Wx14Dx7H	\$77.70 ea

a Madera Chafer *New*

Features Easy Access Drawer for Chafer Fuel. Reclaimed Wood (99).

ITEM	DESCRIPTION	LIST PRICE
3429-99	23Wx14½Dx13½H	\$468.20 ea



b Mission Chafer

Includes Stainless Steel Chafer Cover.

ITEM	DESCRIPTION	LIST PRICE
1368-13	23Wx14½Dx13½H	\$500.10 ea

b



c Eco Modern Chafer

Includes Stainless Steel Chafer Cover.

ITEM	DESCRIPTION	LIST PRICE
1473	23Wx14½Dx13½H	\$468.20 ea

c



d Squared Chafer

Includes Stainless Steel Chafer Cover. Black (13), Stainless Steel (55).

ITEM	DESCRIPTION	LIST PRICE
1613-13	23Wx14½Dx13½H	\$500.10 ea
1613-55	23Wx14½Dx13½H	613.70 ea

d



e One by One Black Chafers

Includes Stainless Steel Chafer Cover.

ITEM	DESCRIPTION	LIST PRICE
3321-13	23Wx14½Dx13½H	\$455.30 ea

e



f Urban Chafer

Includes Stainless Steel Chafer Cover. Stainless (55).

ITEM	DESCRIPTION	LIST PRICE
3396-55	23Wx14½Dx13½H	\$500.10 ea

f



g Luxe Chafers

Includes Stainless Steel Chafer Cover. Specify Color: Copper Trim (51), Stainless Steel Trim (55).

ITEM	DESCRIPTION	LIST PRICE
3017	23Wx14½Dx13½H	\$500.10 ea

g



visit us online at: www.calmil.com **CAL·MIL** call toll-free 800-321-9069

Salad Displays & Sneezeguards



Stainless Steel Salad Bar Ice Housing

Bins Sold Separately.

ITEM	DESCRIPTION	LIST PRICE
1398-55	24Wx32Dx4¼H	\$463.40 ea
1399-55	16Wx24Dx4¼H	364.10 ea

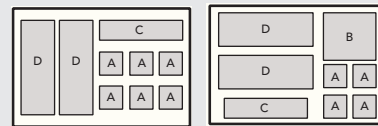

Large Rectangle Variations (Unlimited)



1397 (D)



1391 (A)



1395 (E)

Salad Bar Accessories

Trays for Ice Housings for the Ultimate Salad Bar! Specify Color: Clear (12), Black Melamine (13M), White Melamine (15M).

ITEM	DESCRIPTION	12 LIST PRICE	13M & 15M LIST PRICE
1391 (A)	5Wx5Dx6H	\$22.90 ea	\$35.30 ea
1393 (B)	10Wx10Dx3H	39.20 ea	60.70 ea
1395 (E)	5Wx5Dx3H	21.60 ea	23.20 ea
1396 (C)	5Wx15Dx3H	38.10 ea	57.40 ea
1397 (D)	7Wx20Dx3H	46.90 ea	83.80 ea

Optional Lids

Lids Fit Melamine Boxes Only.

1391-LID	5Wx5D	\$2.80 ea
1393-LID	10Wx10D	6.60 ea
1396-LID	15Wx5D	7.90 ea
1397-LID	7Wx20D	9.00 ea

Optional Housing Condensation Liners

3316	16Wx24x1H	\$98.80 ea
3315	24Wx32Dx1H	131.60 ea

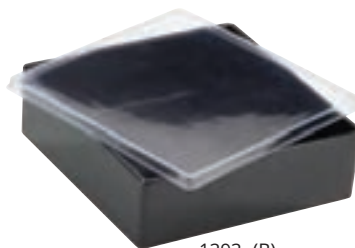

1393 (B)

Clear Salad Bar Ice Housing ^{BPA FREE}

Housing Only — PETG Body. 1398-12 Model Comes with Drain Kit. Salad Bar Accessories Sold Separately.

ITEM	DESCRIPTION	LIST PRICE
1398-12	24Wx32Dx4¼H	\$208.10 ea
1399-12	16Wx24Dx4¼H	116.70 ea



Chilled Salsa/Dressing Server

Fill Bottom of Bin with Ice and Serve! Includes 4 White Crocks.

ITEM	DESCRIPTION	LIST PRICE
3369-13	10½Wx10½Dx7H	\$164.80 ea



a Salad Dressing Caddy

Complete Set Includes:
1 Rack, 4 Bottles, 4 Each of Each Lid Except Dripless,
and 4 Blank Sign Clips.
Dimensions: 13Wx10.75Dx5H
Ice Housings Sold Separately, See Pages 134-139.

ITEM	DESCRIPTION	LIST PRICE
3300-RACK	Caddy Rack Only	\$68.00 ea
3300-SET	Complete Set	201.90 ea

b Bottles, Lids, and Accessories

ITEM	DESCRIPTION	LIST PRICE
3300-28	28 oz. Bottle	\$23.70 ea
3300-28CLIP	Blank Sign Clip	1.60 ea
3300-28SL	Storage Lid	2.10 ea
<i>New</i> 3300-28NODRIP	Dripless Pour Lid	2.50 ea
3300-28LIDL	Large Pour Lid	2.10 ea
3300-28LIDSM	Small Pour Lid	2.10 ea
3300-28JP	Juice Pour Lid	2.10 ea



Set of Salad Dressing Clips *New*

Set Includes 1 EA of Blue Cheese, House, Thousand Island, Italian, Ranch, French, and Balsamic.
2 EA of Blank Clips.

ITEM	DESCRIPTION	LIST PRICE
3300-CLIPSET	Set of 9	\$15.00 ea



3300-28CLIP



3330-28SL



New 3300-28NODRIP



3300-28LIDL



3300-LIDSM



3300-28JP



visit us online at: www.calmil.com **CAL·MIL** call toll-free 800-321-9069

Salad Displays & Sneezeguards



Stainless Steel Insulated Bowls *New*

Not Gel-Filled. Double-Walled for Insulation.

ITEM	DESCRIPTION	LIST PRICE
3446-7	7DIAx3½H	\$44.00 ea
3446-9	9DIAx4H	60.00 ea

Stainless Steel Gel-Filled Cold Bowls ❄️

Keep Gel-Filled Bowl in Freezer for Minimum of 6 Hours to Keep Contents Cold for Hours!

ITEM	DESCRIPTION	LIST PRICE
3326-7-55	7Wx7Dx4H	\$96.40 ea
3326-10-55	10Wx10Dx4H	139.30 ea



Notched

Lids for Round Melamine Jars

ITEM	DESCRIPTION	LIST PRICE
1950-16LID	Fits 16 oz. Jar	\$10.50 ea
1950-16LIDN	Fits 16 oz. Jar - Notched	10.50 ea
1950-32LID	Fits 32 oz Jar	11.30 ea
1950-32LIDN	Fits 32 oz. Jar - Notched	11.30 ea
1950-64LID	Fits 64 oz. Jar	13.40 ea
1950-64LIDN	Fits 64 oz. Jar - Notched	13.40 ea



White and Black Round Jars

Round Write On

Melamine Round Jars

Write-On is Commercial Grade, Scratch and Dent Proof!

ITEM	DESCRIPTION	LIST PRICE
White and Black Jars		
Specify Color: Black (13), White (15).		
1950-16	4DIAx4¼H - 16 oz.	\$18.80 ea
1950-32	5DIAx5½H - 32 oz.	25.30 ea
1950-64	6¾DIAx6¼H - 64 oz.	34.20 ea
Write-On		
1950-16-15C	4DIAx4¼H - 16 oz.	\$22.50 ea
1950-32-15C	5DIAx5½H - 32 oz.	28.90 ea
1950-64-15C	6¾DIAx6¼H - 64 oz.	38.00 ea
3062-15	White Chalkboard Pen	12.40 ea



Square White Only

Square Write On

Melamine Square Jars

Write-On is Commercial Grade, Scratch and Dent Proof!

ITEM	DESCRIPTION	LIST PRICE
White Only		
C1432BODY	4Wx4Dx4H-Jar Only	\$14.80 ea
1432-15	4Wx4Dx4H-w/ Full Lid	22.90 ea
1432-15N	4Wx4Dx4H-w/ Notched Lid	22.90 ea
Write-On		
C1432BODYC	4Wx4Dx4H- Jar Only	\$18.30 ea
1432-15C	4Wx4Dx4H-w/ Full Lid	26.20 ea
1432-15N-C	4Wx4Dx4H-w/ Notched Lid	26.20 ea
3062-15	White Chalkboard Pen	12.40 ea

a Stainless Steel Sneezeguard

ITEM	DESCRIPTION	LIST PRICE
2026-36-55	37¼Wx16Dx20¾H	\$474.50 ea
2026-4-55	49¼Wx16Dx20¾H	553.60 ea
2026-6-55	73¼Wx16Dx20¾H	655.30 ea



b Portable Metal Frame Sneezeguard

Adjustable Height From 14" to 20".
Sneezeguard Angle Also Adjustable.

ITEM	DESCRIPTION	LIST PRICE
751-3	30Wx18Dx20H	\$466.20 ea
751-4	48Wx18Dx20H	553.80 ea
751-6	72Wx18Dx20H	655.50 ea



c Table Mount Buffet Guard - Double Face

Specify Frame Color: Black (13), Silver (74).

ITEM	DESCRIPTION	LIST PRICE
2027-36	37¼Wx27¼Dx21½H	\$565.00 ea
2027-4	49¼Wx27¼Dx21½H	644.10 ea
2027-6	73¼Wx27¼Dx21½H	734.40 ea

d Portable Wire Sneezeguard

Units Can Be Used Individually or Put Side by Side to Accommodate Any Table Size.

ITEM	DESCRIPTION	LIST PRICE
1018	30½Wx21Dx15H	\$314.00 ea
728-13	18Wx26Dx4H - Food Station	397.20 ea
407-8-13	7¾Diax7¾H - Step Bowl	23.70 ea
453-13	9½Wx9½Dx4½H - Fluted Bowl	57.90 ea



Salad Displays & Sneezeguards



Metal Frame Sneezeguard

ITEM	DESCRIPTION	LIST PRICE
1729-3	31Wx18Dx26H	\$465.80 ea
1729-4	49Wx18Dx26H	553.80 ea
1729-6	73Wx18Dx26H	654.60 ea



Portable Metal Frame Sneezeguard

Sneezeguard Angle Adjustable.

ITEM	DESCRIPTION	LIST PRICE
1547-3-74	34½Wx17Dx25H	\$459.70 ea
1547-4-74	50½Wx17Dx25H	552.90 ea
1547-6-74	74½Wx17Dx25H	640.00 ea



Glacier Portable Buffet Sneezeguards

ITEM	DESCRIPTION	LIST PRICE
710-4	48Wx12½Dx18H	\$458.80 ea
710-6	72Wx12½Dx18H	521.10 ea
768	29½Wx12Dx26H	330.90 ea



Portable Attendant Serve Sneezeguard *New*

ITEM	DESCRIPTION	LIST PRICE
3478-3-39	30Wx9Dx18H	\$230.00 ea



a Suspended Sneezeguard
- Double Face

Includes Chain and Mounting Hardware.
Custom Length Upon Request.
Truck Shipment Only.

ITEM	DESCRIPTION	LIST PRICE
772-S	48Wx30Dx6H	\$573.60 ea
774-S	72Wx30Dx6H	661.90 ea



b Suspended Sneezeguard
- Single Face

Includes Chain and Mounting Hardware.
UPS Shipable. Custom Lengths Upon Request.

ITEM	DESCRIPTION	LIST PRICE
776-S	48Wx18Dx2H	\$353.30 ea
778-S	72Wx18Dx2H	419.30 ea

c Iron Small Rectangle Guard
- Single Face

Includes 2 Wire Legs and Guard.

ITEM	DESCRIPTION	LIST PRICE
1456	27½Wx13Dx14H	\$76.10 ea



d Iron Large Rectangle Guard
- Single Face

Includes 2 Wire Legs and Guard.

ITEM	DESCRIPTION	LIST PRICE
1458-30	30Wx17½Dx19H	\$202.90 ea
1458-48	48Wx17½Dx19H	228.40 ea
1458-72	72Wx17½Dx19H	253.60 ea



visit us online at: www.calmil.com **CAL·MIL** call toll-free 800-321-9069

Ice Housings



Bamboo Ice Housing

Includes Clear Polycarbonate Pan.

ITEM	DESCRIPTION	LIST PRICE
475-6-60	6Wx7Dx6½H	\$69.20 ea
475-10-60	10Wx12Dx6½H	121.80 ea
475-12-60	12Wx20Dx6½H	156.90 ea



Eco Modern Ice Housing

Includes Clear Polycarbonate Pan.

ITEM	DESCRIPTION	LIST PRICE
1472	21¼Wx14¼Dx9H	\$383.60 ea



Mission Ice Housing

Includes Clear Polycarbonate Pan.

ITEM	DESCRIPTION	LIST PRICE
1365-12-13	22Wx14Dx8½H	\$503.50 ea
1365-18-13	28Wx20Dx8½H	898.80 ea



Luxe Ice Housing

Includes Clear Polycarbonate Bin.
Stainless Steel Trim (55).

ITEM	DESCRIPTION	LIST PRICE
3005-10-55	10Wx12¼Dx6½H	\$416.80 ea
3005-12-55	12¼Wx20¼Dx6¼H	460.70 ea

a Madera Ice Housings 

Includes Clear Polycarbonate Pan.

ITEM	DESCRIPTION	LIST PRICE
3360-10	13Wx11Dx6½H	\$123.60 ea
3360-12	21Wx13Dx6½H	154.50 ea



b Stainless Steel & Copper Housing

Includes Clear Polycarbonate Pan (Not Pictured).
Specify Color: Copper (51), Stainless Steel (55).

ITEM	DESCRIPTION	LIST PRICE
475-6	6Wx7Dx6H	\$55.50 ea
475-10	10Wx12Dx6H	124.80 ea
475-12	12Wx20Dx6H	166.60 ea



c Classic Melamine Ice Housing

Includes Clear Polycarbonate Pan.
Specify Color: Black (13), White (15).

ITEM	DESCRIPTION	LIST PRICE
475-6	6Wx7Dx6H	\$69.20 ea
475-10	10Wx12Dx6H	132.20 ea
475-12	12Wx20Dx6H	188.80 ea



d Westport Ice Housing

Includes Clear Polycarbonate Pan.

ITEM	DESCRIPTION	LIST PRICE
412-12-52	12Wx20Dx8H	\$379.10 ea
412-18-52	18Wx26Dx8H	524.40 ea



e Insulated Ice Housing

ITEM	DESCRIPTION	LIST PRICE
1256-13	20Wx15Dx6½H	\$239.30 ea



f Iron Ice Housing

Includes Clear Polycarbonate Pan.

ITEM	DESCRIPTION	LIST PRICE
1250-6-13	8Wx7Dx6½H	\$113.20 ea
1250-10-13	12Wx10Dx7H	352.50 ea
1250-12-13	12Wx20Dx7½H	490.90 ea



Ice Housings



Pillared Ice Housing

Includes Clear Polycarbonate Pan.

ITEM	DESCRIPTION	LIST PRICE
451-12	12Wx20Dx8H	\$323.00 ea
451-18	18Wx26Dx8H	447.50 ea



Soho Ice Housing

Includes Clear Polycarbonate Pan.
Frost (33), Faux Glass (43).

ITEM	DESCRIPTION	LIST PRICE
Black Frame		
1581-12-33	20¾Wx14¾Dx8H	\$488.80 ea
1581-12-43	20¾Wx14¾Dx8H	488.80 ea
Silver Frame		
1582-12-33	20¾Wx14¾Dx8H	488.80 ea
1582-12-43	20¾Wx14¾Dx8H	488.80 ea



Squared Ice Housing

Includes Clear Polycarbonate Pan.
Black (13), Stainless Steel (55).

ITEM	DESCRIPTION	LIST PRICE
1603-12-13	21Wx12½Dx6½H	\$488.80 ea
1603-12-55	21Wx12½Dx6½H	570.20 ea



One by One Ice Housing

Includes Clear Polycarbonate Pan.
Specify Color: Black (13), Silver (74).

ITEM	DESCRIPTION	LIST PRICE
1135-12	23½Wx15¾Dx7¼H	\$488.80 ea



Glacier Ice Housing

Includes Clear Polycarbonate Pan.

ITEM	DESCRIPTION	LIST PRICE
413-12-13	12Wx20Dx8H	\$527.50 ea
413-18-13	18Wx26Dx8H	898.80 ea



Midnight Bamboo Housings

Includes Clear Polycarbonate Pan.

ITEM	DESCRIPTION	LIST PRICE
475-6-96	6Wx7Dx6½H	\$69.20 ea
475-10-96	10Wx12Dx6½H	121.80 ea
475-12-96	12Wx20Dx6½H	156.90 ea



a Union Square Housing Riser

Ice Housings Sold Separately.

ITEM	DESCRIPTION	LIST PRICE
3060-13	14Wx21Dx17H	\$103.00 ea
475-10-55	10x12 Stainless Ice Housing	124.80 ea



b Union Square Ice Housing

Includes Clear Polycarbonate Pan.

ITEM	DESCRIPTION	LIST PRICE
3359-12-13	23½Wx15¾Dx7¼H	\$484.10 ea



c Urban Stainless Steel Ice Housings

Includes Clear Polycarbonate Pan.

ITEM	DESCRIPTION	LIST PRICE
3395-10-55	12¾Wx10¾Dx6¾H	\$416.80 ea
3395-12-55	20¾Wx12¾Dx7¼H	460.70 ea

d Carafe and Carafe Collar

Ice Housing Sold Separately.

ITEM	DESCRIPTION	LIST PRICE
438	1 Liter Carafe	\$12.90 ea
707-12	12Wx20Dx6H - Carafe Collar	110.80 ea



e Acrylic Ice Housings

Includes Clear Polycarbonate Pan.

Mirror (24).

ITEM	DESCRIPTION	LIST PRICE
473-12-24	12Wx20Dx6H	\$357.60 ea
473-18-24	18Wx26Dx6H	695.10 ea



Fully Insulated Ice Housings

Specify Color: Black (17), Mirror (24).

ITEM	DESCRIPTION	LIST PRICE
368-12	12Wx20Dx6H	\$507.90 ea

f Fully Insulated Housing

Black (13), Mirror (24).

ITEM	DESCRIPTION	LIST PRICE
463-12-13	12Wx20Dx6H	\$287.30 ea
463-18-13	18Wx26Dx6H	419.30 ea
463-12-24	12Wx20Dx6H	375.30 ea
463-18-24	18Wx26Dx6H	579.80 ea



Ice Housings



Chalkboard Ice Housings

Includes Clear Polycarbonate Pan.
Can also be used as crates!

ITEM	DESCRIPTION	LIST PRICE
3354-6	7Wx7Dx8H	\$72.10 ea
3354-10	13Wx11Dx7H	123.60 ea
3354-12	13½Wx21½Dx7H	154.50 ea
3062-15	White Chalkboard Pen	12.40 ea



476-10-13

Ice Housing Stand

2 Tier In-line Frame for 475-10 Ice Housings.
Stand Only, Housings Sold Separately.

ITEM	DESCRIPTION	LIST PRICE
476-10	14Wx21Dx17H - Silver	\$81.30 ea
476-10-13	14Wx21Dx17H - Black	81.30 ea



476-6

Silver Ice Housing Stand

2 Tier In-line Frame for 475-6 Ice Housings. Stand
Only, Housings Sold Separately.

ITEM	DESCRIPTION	LIST PRICE
476-6	7Wx15Dx13H	\$64.70 ea

Folding Ice Housings

Inserts Pans Sold Separately. Black (13), Mirror (24).

ITEM	DESCRIPTION	LIST PRICE
BH4220-13	12Wx20Dx6H - Black	\$264.40 ea
BH4618-13	18Wx26Dx6H - Black	310.80 ea
242-12-24	12Wx20Dx6H - Mirror	343.50 ea

Optional Clear Insert Pans

477-12CL	12Wx20Dx6H	79.90 ea
477-18	18Wx26Dx6H	130.50 ea

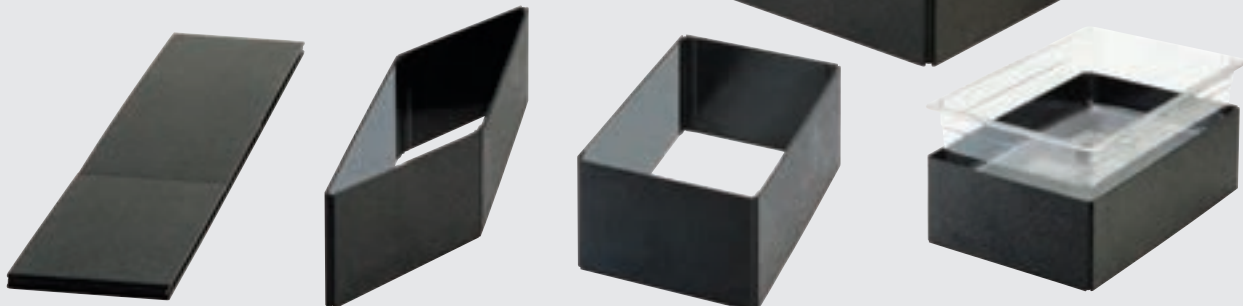



a

a Melamine Slate Ice Housings *New*

Includes Black Ice Pan.

ITEM	DESCRIPTION	LIST PRICE
3552-6-65M	6Wx7Dx7H	\$69.20 ea
3552-10-65M	10Wx12Dx7H	132.20 ea
3552-12-65M	12Wx20Dx7H	188.80 ea



b

b Industrial Ice Housing *New*

Includes Polycarbonate Pan.

ITEM	DESCRIPTION	LIST PRICE
3438-12	21½Wx14½Dx8H	\$488.80 ea

c Glacier Ice Housings

Metal/Acrylic. Includes Polycarbonate Pan. 413-24-13 has a Drain.

ITEM	DESCRIPTION	LIST PRICE
413-12-13	12Wx20Dx8H	\$527.50 ea
413-18-13	18Wx26Dx8H	898.80 ea
413-24-13*	24Wx48Dx8H	1,850.10 ea

*Ships by Truck Only



c

d Durable ABS Dual Bin Icer

ITEM	DESCRIPTION	LIST PRICE
1285*	48Wx25½Dx6H	\$373.00 ea

*Ships by Truck Only



d

Ice Housings



IP402

2 Tier Metal Ice Housing

Includes Stand, PETG Ice Pan, Drainage Hose, and Basic LED Lighting.

Ships by Truck Only.

Specify Color: Black (13), Platinum (39).

ITEM	DESCRIPTION	LIST PRICE
IP402	24Wx48Dx12.5H	\$2,398.40 ea

Optional Portable LED Unit

Over 20 Speeds and Color Patterns. Battery Operated and Convenient for Indoor and Outdoor Use. 8D Batteries Last 28+ Hours. Optional AC Power Option Sold Separately.

ITEM	DESCRIPTION	LIST PRICE
LED100	Small LED Light Pack	\$755.90 ea
LED200	Large LED Light Pack	1,006.70 ea
IPAD	AC Adapter for LED 100 & 200	125.80 ea



IP2020



Water Containment Units Available in Large or Small.

Water Containment Unit

Collects and Stores Melted Ice Water for Hours. Designed to Fit Ultimate Ice Housing Systems Only.

ITEM	DESCRIPTION	LIST PRICE
WU100	13Wx22Dx3H - Small	\$285.80 ea
WU200	17Wx42Dx3H - Large	405.60 ea

Large Ultimate Ice Housing System

Includes PETG Ice Pan, Water Containment Unit, and Basic LED Lighting.

Ships by Truck Only.

Specify Color: Black (13), Platinum (39).

ITEM	DESCRIPTION	LIST PRICE
IP1020	19Wx27Dx8H	\$1,120.80 ea
IP2020	24Wx48Dx10H	1,866.60 ea

Optional Portable LED Unit

Over 20 Speeds and Color Patterns. Battery Operated and Convenient for Indoor and Outdoor Use. 8D Batteries Last 28+ Hours. Optional AC Power Option Sold Separately.

ITEM	DESCRIPTION	LIST PRICE
LED200	Large LED Light Pack	\$1,006.70 ea
IPAD	AC Adapter for LED 100 & 200	125.80 ea



Stainless Steel Ice Pedestal

Includes Stand, PETG Ice Pan, Drainage Hose, and Basic LED Lighting.

ITEM	DESCRIPTION	LIST PRICE
3033-55	28½Wx20½Dx8½H	\$899.40 ea
3034-55*	49½Wx25½Dx8½H	1,563.70 ea
3326-7-55	Stainless Cold Bowl - 7Wx7D	96.40 ea

Optional Water Containment Unit

WU100	13Wx22Dx3H - Small	\$285.80 ea
WU200	17Wx42Dx3H - Large	405.60 ea

*Ships by Truck Only



a Original Large Ice Carving Pedestal

Includes Stand, PETG Ice Pan, Drainage Hose, and Basic LED Lighting.
Ships by Truck Only.

Specify Color: Black (13), Platinum (39).

ITEM	DESCRIPTION	LIST PRICE
IP202	24Wx48Dx8H	\$1,563.80 ea

Optional Portable LED Unit

Over 20 Speeds and Color Patterns. Battery Operated and Convenient for Indoor and Outdoor Use. 8 D Batteries Last 28+ Hours. Optional AC Power Option Sold Separately.

ITEM	DESCRIPTION	LIST PRICE
LED200	Large LED Light Pack	\$1,006.70 ea
IPAD	AC Adapter for LED 100 & 200	125.80 ea



b Small Metal Ice Carving Pedestal

Includes Stand, PETG Ice Pan, Drainage Hose, and Basic LED Lighting.

Specify Color: Black (13), Platinum (39).

ITEM	DESCRIPTION	LIST PRICE
IP102	19Wx27Dx8H	\$899.40 ea

c Optional Portable LED Unit

Over 20 Speeds and Color Patterns. Battery Operated and Convenient for Indoor and Outdoor Use. 8 D Batteries Last 28+ Hours. Optional AC Power Option Sold Separately.

ITEM	DESCRIPTION	LIST PRICE
LED100	Small LED Light Pack	\$755.90 ea
IPAD	AC Adapter for LED 100 & 200	125.80 ea

d Extra Rectangular Ice Pans

ITEM	DESCRIPTION	LIST PRICE
IP152	20¼Wx28½Dx4H	\$623.80 ea
IP252	25Wx50½Dx4H	1,087.00 ea

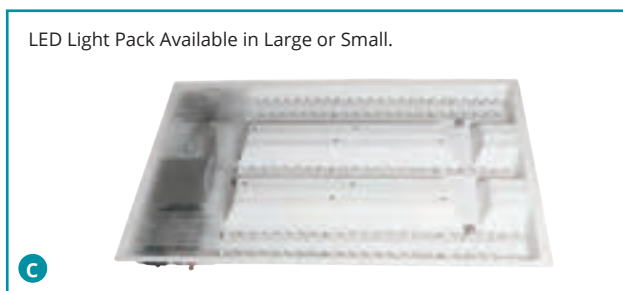

Ice Housings & Ice Carvings



Small Mirror Ice Carving Pedestal with LED Feature

Includes PETG Ice Pan, Drainage Hose, and Built in LED Lighting with Multiple Light Pattern Selections. Available Only in Mirror With 110 or 220 Volt.

ITEM	DESCRIPTION	LIST PRICE
Small		
IP101-110	19Wx27Dx10H - 110 Volts	\$2,276.60 ea
IP101-220	19Wx27Dx10H - 220 Volts	2,276.60 ea
Large		
IP201-110*	24Wx48Dx14H - 110 Volts	\$4,376.00 ea
IP201-220*	24Wx48Dx14H - 220 Volts	4,376.00 ea

*Ships By Truck Only

- Recessed Acrylic Mirror Panels Provide Maximum Protection.
- Built-In LED Lighting with Easily Adjustable Multiple Light Pattern Selections.
- Durable and Chip Resistant Commercial Grade PETG Pans.
- Convenient Self-Drain Design.
- Quality Construction Provides Support Up to 500 lbs.



Rotating Ice Carving Mirror Pedestal

Includes PETG Ice Pan, Drainage Hose, and Built in LED Lighting with Multiple Light Pattern Selections. Available Only in Mirror With 110 or 210 Volt.

ITEM	DESCRIPTION	LIST PRICE
IP501-110	24DIAx14H - 110 Volts	\$3,865.20 ea
IP501-220	24DIAx14H - 220 Volts	3,865.20 ea



Square Illuminated Trays BPA FREE

Includes: Light Box, Deep Tray, and Drain Kit.

ITEM	DESCRIPTION	LIST PRICE
902-12*	24Wx24Dx3H	\$1,279.70 ea

*Shipped in Two Boxes

Rectangular Illuminated Trays BPA FREE

Includes: Light Box, Tray, and Drain Kit.

ITEM	DESCRIPTION	LIST PRICE
903-12	40Wx22Dx3H	\$1,652.30 ea
904-12*	54Wx24Dx3½H	1,963.10 ea

*Ships by Truck Only in Two Boxes.



Rectangular Clear Ice Trays BPA FREE

Includes: Tray, Pair of Brackets and Drain Kit.

ITEM	DESCRIPTION	LIST PRICE
986-12	40Wx22Dx3H	\$661.90 ea
987-12*	54Wx24Dx3½H	772.30 ea
989-12	29Wx18Dx3H	485.40 ea

*Ships by Truck Only in Two Boxes.



Square Clear Ice Tray BPA FREE

Includes: Tray, Pair of Brackets, and Drain Kit.

ITEM	DESCRIPTION	LIST PRICE
985-12	24Wx24Dx3H	\$419.30 ea

visit us online at: www.calmil.com **CAL·MIL** call toll-free 800-321-9069

Riser Displays



Westport/Midnight Bamboo Cube Riser Set

Sizes: 9" Square, 7" Square, and 5" Square.

ITEM	DESCRIPTION	LIST PRICE
1915	Westport Set	\$152.10 ea
1915-96	Midnight Bamboo Set	151.90 ea



Luxe Rectangular Risers

Stainless Steel Trim (55).

ITEM	DESCRIPTION	LIST PRICE
3025-55	12Wx20Dx6½H	\$359.90 ea
3026-55	12Wx10Dx6½H	325.70 ea



Vintage Stair Step Risers

ITEM	DESCRIPTION	LIST PRICE
3038-4	20Wx10Dx4H	\$164.80 ea
3038-8	20Wx10Dx8H	185.40 ea
3038-12	20Wx10Dx12H	206.00 ea



Stair Step Risers

Specify Color: Bamboo (60), Midnight Bamboo (96).

ITEM	DESCRIPTION	LIST PRICE
1934-4	20Wx10Dx4H	\$64.00 ea
1934-8	22Wx10Dx8H	81.60 ea
1934-12	24Wx10Dx12H	108.00 ea



a Bamboo
Cube/Rectangle Risers

ITEM	DESCRIPTION	LIST PRICE
166-3-60	20Wx7Dx3H	\$73.50 ea
166-7-60	20Wx7Dx7H	119.00 ea
166-11-60	20Wx7Dx11H	131.60 ea
432-3-60	12Wx12Dx3H	86.00 ea
432-6-60	12Wx12Dx6H	98.40 ea
432-9-60	12Wx12Dx9H	110.50 ea

b Midnight Bamboo
Cube/Rectangle Risers

ITEM	DESCRIPTION	LIST PRICE
166-3-99	20Wx7Dx3H	\$73.50 ea
166-7-99	20Wx7Dx7H	119.00 ea
166-11-99	20Wx7Dx11H	131.60 ea
432-3-99	12Wx12Dx3H	86.00 ea
432-6-99	12Wx12Dx6H	98.40 ea
432-9-99	12Wx12Dx9H	110.50 ea

c Madera
Cube/Rectangle Risers *New*

ITEM	DESCRIPTION	LIST PRICE
166-3-99	20½Wx7Dx3¼H	\$100.00 ea
166-7-99	20½Wx7Dx7H	136.00 ea
166-11-99	20½Wx7Dx11H	160.00 ea
432-3-99	12Wx12Dx3¼H	112.00 ea
432-6-99	12Wx12Dx6H	120.00 ea
432-9-99	12Wx12Dx9H	128.00 ea

visit us online at: www.calmil.com **CAL·MIL** call toll-free 800-321-9069

Riser Displays



3331-60



3332-10-60



3332-4-96

Bamboo Crate Risers

Platters are Sold Separately.
Specify Color: Bamboo (60), Midnight Bamboo (96).

ITEM	DESCRIPTION	LIST PRICE
3331	9Wx9Dx18H	\$171.40 ea
3332-4	12Wx12Dx4H	96.40 ea
3332-7	12Wx12Dx7H	107.10 ea
3332-10	12Wx12Dx10H	139.30 ea

Bamboo Shelves

Specify Color: Bamboo (60), Midnight Bamboo (96).

ITEM	DESCRIPTION	LIST PRICE
1435-1224	12Wx24Dx1½H	\$108.80 ea
1435-1232	12Wx32Dx1½H	139.30 ea
1435-1248	12Wx48Dx1½H	154.50 ea
C732	7Wx32Dx1½H	86.90 ea

Large Porcelain Square Platter

ITEM	DESCRIPTION	LIST PRICE
PP252	11Wx11Dx1H	\$40.80 ea



3332-7-96



Cold Concept Cold Pack System

Cold Concept Set

Complete Set Includes: Porcelain Plate, Liner, and Cold Pack. Place Cold Pack in Freezer for a Minimum of 6 Hours. Keeps Contents Cold for 2-3 Hours.

ITEM	DESCRIPTION	LIST PRICE
3063	Porcelain Plate, Liner, Cold Pack	129.20 ea
3402	Hinged Dome Cover	56.70 ea



a Round Melamine Jars

Specify Color: Black (13), White (15).

ITEM	DESCRIPTION	LIST PRICE
1950-16	4DIAx4¼H - 16 oz.	\$18.80 ea
1950-32	5DIAx5½H - 32 oz.	25.30 ea
1950-64	6¾DIAx6¼H - 64 oz.	34.20 ea

b Round Melamine Jars w/ Write-On

Label is Commercial Grade, Scratch and Dent Proof!

ITEM	DESCRIPTION	LIST PRICE
1950-16-15C	4DIAx4¼H - 16 oz.	\$22.50 ea
1950-32-15C	5DIAx5½H - 32 oz.	28.90 ea
1950-64-15C	6¾DIAx6¼H - 64 oz.	38.00 ea



c Melamine Square Jars

ITEM	DESCRIPTION	LIST PRICE
White Only		
C1432BODY	4Wx4Dx4H Jar Only	\$14.80 ea
1432-15	4Wx4Dx4H Jar w/Full Lid	22.90 ea
1432-15N	4Wx4Dx4H Jar w/Notched Lid	22.90 ea

ITEM	DESCRIPTION	LIST PRICE
Write-On		
C1432BODYC	4Wx4Dx4H Jar Only	\$18.30 ea
1432-15C	4Wx4Dx4H Jar w/Full Lid	26.20 ea
1432-15N-C	4Wx4Dx4H Jar w/Notched Lid	26.20 ea

d Rectangle Crate Risers

These Risers Can Also be Used as Bins and Work with Our Bamboo Shelves.
Specify Color: Bamboo (60),
Midnight Bamboo (96).

ITEM	DESCRIPTION	LIST PRICE
1943-3	20Wx7Dx3H	\$73.80 ea
1943-7	20Wx7Dx7H	119.10 ea
1943-11	20Wx7Dx11H	132.40 ea

e Square Crate Risers

These Risers Can Also be Used as Bins and Work with Our Bamboo Shelves.
Specify Color: Bamboo (60),
Midnight Bamboo (96).

ITEM	DESCRIPTION	LIST PRICE
1944-6	6Wx6Dx6H	\$39.80 ea
1944-9	9Wx9Dx9H	79.50 ea
1944-12	12Wx12Dx12H	132.40 ea
3332-4	12Wx12Dx4H	96.40 ea
3332-7	12Wx12Dx7H	107.10 ea
3332-10	12Wx12Dx10H	139.30 ea



Riser Displays



Midnight Bamboo

Example of what can be done with Library Displays and Cubes.
Two Library Displays with One Cube.



Bamboo

a Library Displays

Shelf is Removable.
Specify Color: Bamboo (60),
Midnight Bamboo (96), Reclaimed Wood (99).

ITEM	DESCRIPTION	LIST PRICE
1933	38Wx12Dx24H	\$573.70 ea



Bamboo (60)



Midnight Bamboo (96)

b Library Cubes

Dimensions: 12Wx12Dx12H.

ITEM	DESCRIPTION	LIST PRICE
1929-12-60	Bamboo	\$121.30 ea
1929-12-96	Midnight Bamboo	121.30 ea
1929-12-99	Reclaimed Wood	136.00 ea



Reclaimed Wood (99)



New
Reclaimed Wood

a Library Displays

Shelf is Removable.
Specify Color: Bamboo (60),
Midnight Bamboo (96), Reclaimed Wood (99).

ITEM	DESCRIPTION	LIST PRICE
1933	38Wx12Dx24H	\$573.70 ea



Bamboo (60)



Midnight Bamboo (96)

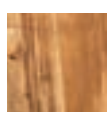

Reclaimed Wood (99)

b Library Cubes

Dimensions: 12Wx12Dx12H.

ITEM	DESCRIPTION	LIST PRICE
1929-12-60	Bamboo	\$121.30 ea
1929-12-96	Midnight Bamboo	121.30 ea
1929-12-99	Reclaimed Wood	136.00 ea



Midnight Bamboo



visit us online at: www.calmil.com **CAL·MIL** call toll-free 800-321-9069

Riser Displays



Elevation Risers

Glass Shelves Sold Separately.

ITEM	DESCRIPTION	LIST PRICE
1465-5-13	8Wx8Dx5H	\$112.50 ea
1465-10-13	8Wx8Dx10H	152.10 ea
1465-15-13	8Wx8Dx15H	187.40 ea
1466-5-13	12Wx12Dx7H	128.80 ea
1466-10-13	12Wx12Dx10H	175.60 ea
1466-15-13	12Wx12Dx15½H	222.40 ea



Union Square Dual Risers

Shelves Sold Separately.

ITEM	DESCRIPTION	LIST PRICE
3358-13	5Wx14Dx10H	\$133.90 ea

Optional Shelves

C732GLASS	7Wx32D - Glass	\$79.90 ea
C732-60	7Wx32D - Bamboo	86.90 ea
C732-96	7Wx32D - Midnight Bamboo	86.90 ea



Metal Triangular Riser

Risers Sold Individually.
Shelves Sold Separately.

ITEM	DESCRIPTION	LIST PRICE
1528-12-13	9Wx8Dx12H	\$109.20 ea



Bella Arte Adjustable Shelf

Adjustable Shelf to Heights of 7", 9", 11".
Includes 7" x 32" Glass Shelf.

ITEM	DESCRIPTION	LIST PRICE
741	32Wx8½Dx13H	\$284.00 ea



a Squared Metal Cube Risers

Glass Trays Sold Separately
Black (13), Stainless Steel (55).

ITEM	DESCRIPTION	LIST PRICE
1607-5-13	5Wx5Dx5H	\$68.10 ea
1607-5-55	5Wx5Dx5H	79.60 ea
1607-7-13	7Wx7Dx7H	96.60 ea
1607-7-55	7Wx7Dx7H	113.60 ea
1607-9-13	9Wx9Dx9H	147.70 ea
1607-9-55	9Wx9Dx9H	170.50 ea

Bamboo Riser Shelves

ITEM	DESCRIPTION	LIST PRICE
1431-16-60	16Wx16D - L Shape	\$108.00 ea
1431-24-60	24Wx24D - L Shape	154.50 ea
1435-1212-60	12Wx12D - Square	66.20 ea
1435-1616-60	16Wx16D - Square	108.80 ea
1435-2424-60	24Wx24D - Square	154.50 ea
1435-1624-60	24Wx16D - Rectangle	132.40 ea
1443-12-60	12" Diameter - Round	66.20 ea
1443-16-60	16" Diameter - Round	96.40 ea
1443-24-60	24" Diameter - Round	154.50 ea
1444-16-60	16Wx16D - Curved	108.80 ea
1444-24-60	24Wx24D - Curved	154.50 ea
C732-60	32Wx7D - Rectangle	86.90 ea
1949-60	32Wx12D - Rectangle	93.60 ea

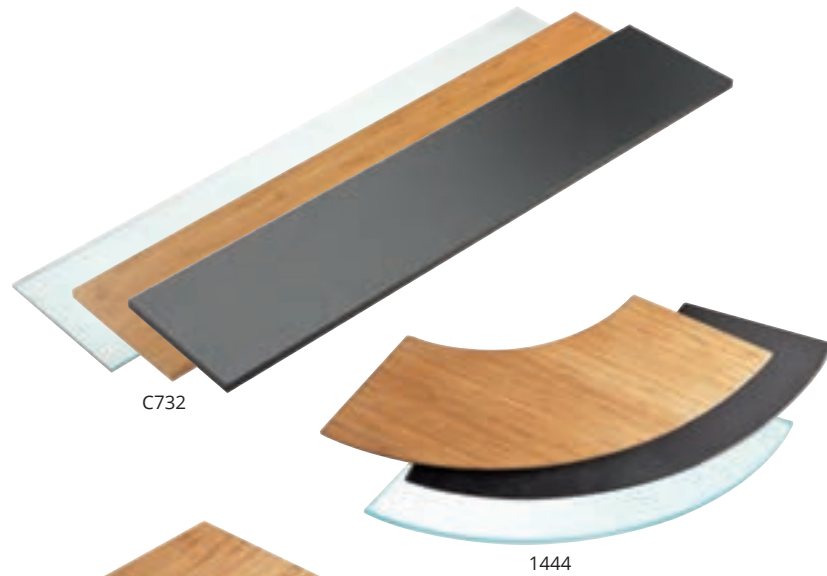

Midnight Bamboo Riser Shelves

ITEM	DESCRIPTION	LIST PRICE
1431-16-96	16Wx16D - L Shape	\$108.80 ea
1431-24-96	24Wx24D - L Shape	154.50 ea
1435-1212-96	12Wx12D - Square	66.20 ea
1435-1616-96	16Wx16D - Square	108.80 ea
1435-2424-96	24Wx24D - Square	154.50 ea
1435-1624-96	24Wx16D - Rectangle	132.40 ea
1443-12-96	12" Diameter - Round	66.20 ea
1443-16-96	16" Diameter - Round	96.40 ea
1443-24-96	24" Diameter - Round	154.50 ea
1444-16-96	16Wx16D - Curved	108.80 ea
1444-24-96	24Wx24D - Curved	154.50 ea
C732-96	32Wx7D - Rectangle	86.90 ea
1949-96	32Wx12D - Rectangle	93.60 ea



Tempered Glass Riser Shelves

ITEM	DESCRIPTION	LIST PRICE
1431-16	16Wx16D - L Shape	\$108.80 ea
1431-24	24Wx24D - L Shape	152.10 ea
1435-1212	12Wx12D - Square	44.50 ea
1435-1616	16Wx16D - Square	58.60 ea
1435-2424	24Wx24D - Square	93.60 ea
1435-1624	24Wx16D - Rectangle	70.30 ea
1443-12	12" Diameter - Round	58.50 ea
1443-16	16" Diameter - Round	93.60 ea
1443-24	24" Diameter - Round	140.40 ea
1444-16	16Wx16D - Curved	105.40 ea
1444-24	24Wx24D - Curved	152.10 ea
C732GLASS	32Wx7D - Rectangle	79.90 ea

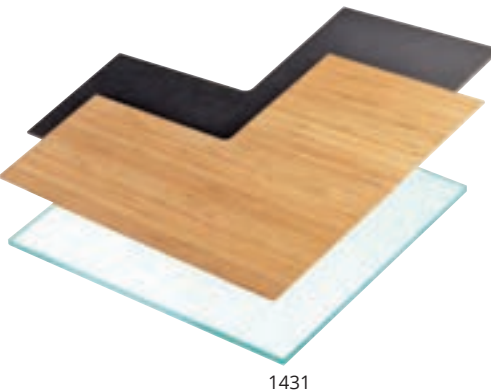

visit us online at: www.calmil.com **CAL·MIL** call toll-free 800-321-9069

Riser Displays

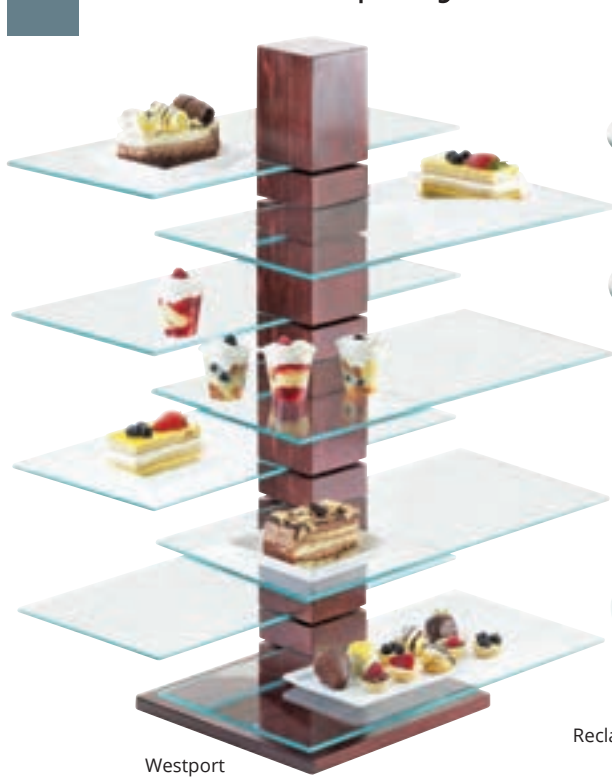

Westport



Reclaimed Wood



Glass Shelves for Pillar Risers

For Square and Round, Takes 2 Each to Form Full Circle or Full Square.

ITEM	DESCRIPTION	LIST PRICE
831-SQ	19¾Wx10D - 1/2 Square	\$52.70 ea
831-RD	19¾Wx10D - 1/2 Round	58.60 ea
C732GLASS	32Wx7D - Rectangle	79.90 ea

Pillar Risers

Shelves Sold Separately.
Westport (52), Reclaimed Wood (99).

ITEM	DESCRIPTION	LIST PRICE
791-52	9Wx9Dx32½H	\$234.10 ea
791-99	9Wx9Dx32½H	468.20 ea



Midnight Bamboo Silver Frame Riser

ITEM	DESCRIPTION	LIST PRICE
1940-96	28Wx12Dx24H	\$375.10 ea



3447-71



3444-71

Maple Block Risers *New*

ITEM	DESCRIPTION	LIST PRICE
3444-71	13Wx23Dx12H	\$280.00 ea
3447-71	13½Wx23Dx12H	280.00 ea



1464-13 w/ 1449-99 Shelves

3 Tier Riser Frame

Frame Only. Shelves Sold Separately.
Specify Frame Color: Black (13), Brown (48).

ITEM	DESCRIPTION	LIST PRICE
1464	18¼Wx11Dx25H	\$210.70 ea

Optional Shelves

Sold Individually, Not as Sets.
Specify Color: Bamboo (60), Crushed Bamboo (68),
Midnight Bamboo (96) Reclaimed Wood (99).

1449	32Wx11½Dx½H	\$128.80 ea
1449-99	32Wx11½Dx½H	245.90 ea



1464-13 w/ 1449-96 Shelves



1464-48 w/ 1449-68 Shelves

Riser Displays



Industrial Rectangle Risers

ITEM	DESCRIPTION	LIST PRICE
3418-3	20Wx8Dx3H	\$119.50 ea
3418-5	20Wx8Dx5H	121.50 ea
3418-7	20Wx8Dx7H	123.60 ea



Industrial Square Risers

ITEM	DESCRIPTION	LIST PRICE
3417-3	10Wx10Dx3H	\$82.40 ea
3417-5	10Wx10Dx5H	84.50 ea
3417-7	10Wx10Dx7H	86.50 ea



Bamboo Stair-Step Risers

ITEM	DESCRIPTION	LIST PRICE
3374-4-60	24Wx11¼Dx4H	\$164.80 ea
3374-8-60	24Wx11¼Dx8H	175.10 ea
3374-12-60	24Wx11¼Dx12H	185.40 ea



Industrial Madera Riser New

Reclaimed Wood (99).

ITEM	DESCRIPTION	LIST PRICE
3473-99	24Wx10Dx12H	\$220.00 ea



Aluminum Risers New

Frame Only, Trays Sold Separately.

ITEM	DESCRIPTION	LIST PRICE
1562-2	21¼Wx7¾Dx2¼H	\$136.40 ea
1562-4	21¼Wx7¾Dx4H	136.40 ea
1562-6	21¼Wx7¾Dx6H	136.40 ea
Optional Trays		
166-3-60	20½Wx7¼Dx3H	\$73.50 ea



Square Change-Up Risers New

ITEM	DESCRIPTION	LIST PRICE
Risers		
1476-10	10½Wx10½Dx4H	\$124.10 ea
1476-12	12½Wx12½Dx6H	128.80 ea
Optional Inserts - Deep and Flat Trays		
1481-10-60	Small Flat Tray	\$28.00 ea
1481-12-60	Large Flat Tray	32.80 ea
1477-10-60	Small Deep Tray	42.10 ea
1477-12-60	Large Deep Tray	46.80 ea

a Iron Risers BPA FREE

Specify Top: Bamboo (60), Slate (65).

ITEM	DESCRIPTION	LIST PRICE
1711-3	12Wx12Dx3H	\$98.40 ea
1711-5	12Wx12Dx5H	100.80 ea
1711-7	12Wx12Dx7H	110.50 ea



Bamboo

b V-Leg Rectangular Metal Riser Set

Set of 3 Risers.

ITEM	DESCRIPTION	LIST PRICE
SR630-13	12Wx8Dx3H	\$248.20 ea
	12Wx8Dx7H	
	12Wx8Dx12H	



Slate

c Metal Riser Ring Set

Stackable for Storage. Includes All 3 Stands (8", 10" and 12" Diameter).

ITEM	DESCRIPTION	LIST PRICE
MR1300-13	Set of 3	\$302.30 ea



Stackable For Easy Storage

visit us online at: www.calmil.com **CAL·MIL** call toll-free 800-321-9069

Riser Displays



Bamboo Cupcake Display

ITEM	DESCRIPTION	LIST PRICE
1318-60	20Wx20Dx17¼H	\$204.60 ea



Madera 3 Tier Riser Display New

Reclaimed Wood (99).

ITEM	DESCRIPTION	LIST PRICE
3428-99	20¼Wx20¼Dx20H	\$300.00 ea



CH107

Multi-Tier Cone Display

Bamboo Serving Cones Sold Separately.
Specify Color: Black (13), Platinum (39).

ITEM	DESCRIPTION	LIST PRICE
3330	20Diax20¼H	\$235.70 ea
CH107	Sleeve of 300	128.50 ea



Acrylic Cone Pedestal

Hole Size: 1¼" Diameter.

ITEM	DESCRIPTION	LIST PRICE
1265	12Wx12Dx7H	\$60.20 ea



Curl Risers Set

Specify Color: Black (13),
Stainless Steel (55).

ITEM	DESCRIPTION	LIST PRICE
1433	18Wx6Dx6H - Set of 3	\$159.00 ea
1434	12W¼x6Dx6H - Set of 3	99.60 ea



a Classic Stair-Step Risers

Nesting Sets with Four Sizes Each.

ITEM	DESCRIPTION	LIST PRICE
237	Acrylic Black Set of 4	\$125.70 set
238	Acrylic Clear Set of 4	115.70 set
239	Stainless Set of 4	271.00 set
239-2	5Wx5Dx2H - Stainless	40.70 ea
239-4	6Wx6Dx4H - Stainless	51.50 ea
239-6	7Wx7Dx6H - Stainless	70.50 ea
239-8	8Wx8Dx8H - Stainless	113.70 ea



b Iron Riser

ITEM	DESCRIPTION	LIST PRICE
1247-3	21Wx7½Dx3¾H	\$147.50 ea
1247-7	21Wx7½Dx6½H	159.80 ea
1247-11	21Wx7½Dx11½H	172.00 ea

c White Acrylic Square Risers

Stackable or Use Individually.

ITEM	DESCRIPTION	LIST PRICE
1917-1-15	9½Wx9½Dx4¾H	\$62.20 ea
1917-2-15	14½Wx14½Dx8H	79.10 ea

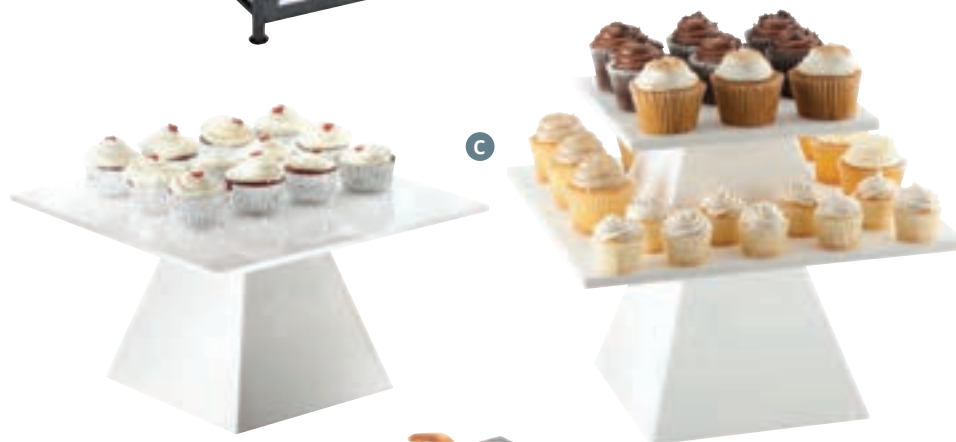

d One by One Tiered Riser

Shelf Inserts Sold Separately.

Specify Color Frame: Black (13), Silver (74).

ITEM	DESCRIPTION	LIST PRICE
1140	32¼Wx13Dx10½H	\$176.50 ea

Optional Shelves

White Corian (15), Bamboo (60).

ITEM	DESCRIPTION	LIST PRICE
1128-1212-15	12Wx12D	\$39.40 ea
1128-1212-60	12Wx12D	38.50 ea



Riser Displays



Bamboo Riser with Swivel Shelves

a Maple Blocks

ITEM	DESCRIPTION	LIST PRICE
3055-88-71	8Wx8Dx1½H	\$41.20 ea
3055-1212-71	12Wx12Dx1½H	82.40 ea
3055-1216-71	12Wx16Dx1½H	113.30 ea

b Charcoal Building Blocks

ITEM	DESCRIPTION	LIST PRICE
3056-333	3½Wx3½Dx3H	\$20.60 ea
3056-336	3½Wx3½Dx6H	24.70 ea
3056-338	3½Wx3½Dx8H	28.80 ea
3056-533	5½Wx3½Dx3H	24.70 ea
3056-536	5½Wx3½Dx6H	28.80 ea
3056-538	5½Wx3½Dx8H	33.00 ea

c Bamboo and Espresso Risers

ITEM	DESCRIPTION	LIST PRICE
Bamboo		
3028-60	10½Wx10½Dx8H - w/ Corian Top	\$206.00 ea
3028-60L	10½Wx10½Dx8H - Underlit w/ Frost	206.00 ea
3029-60	12Wx12Dx12H - w/ Corian Top	236.90 ea
3029-60L	12Wx12Dx12H - Underlit w/ Frost	236.90 ea
Espresso		
3028-57	10½Wx10½Dx8H - w/ Corian Top	\$206.00 ea
3028-57L	10½Wx10½Dx8H - Underlit w/ Frost	206.00 ea
3029-57	12Wx12Dx12H - w/ Corian Top	236.90 ea
3029-57L	12Wx12Dx12H - Underlit w/ Frost	236.90 ea

d Bamboo Swivel Riser

Risers Swivel to Create More Options!

ITEM	DESCRIPTION	LIST PRICE
3347-3-60	12DIAx11H	\$329.60 ea

a Faux Glass Stair-Step Riser

ITEM	DESCRIPTION	LIST PRICE
1463	11½Wx20Dx7H	\$132.10 ea



b Acrylic Mirror Cube Risers

ITEM	DESCRIPTION	LIST PRICE
MC700	Set of 3 (8", 10", 12")	\$745.70 ea
MC706	6Wx6Dx6H	142.30 ea
MC708	8Wx8Dx8H	202.30 ea
MC710	10Wx10Dx10H	264.40 ea
MC712	12Wx12Dx12H	341.20 ea

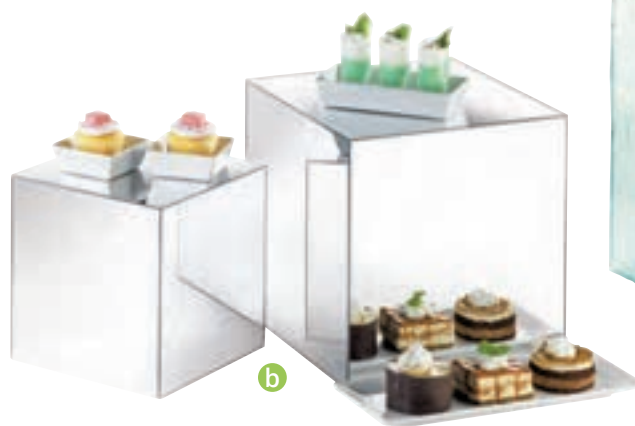

c Glacier Faux Glass Risers

ITEM	DESCRIPTION	LIST PRICE
432-8-43	8Wx8Dx8H	\$88.20 ea
432-13-43	13Wx8Dx6H	117.40 ea



d Clear Acrylic Cubes

Store Inside Each Other To Save Space.

ITEM	DESCRIPTION	LIST PRICE
CC334	Set of 3 (8", 10", 12")	\$418.10 ea
CC306	6Wx6Dx6H	108.50 ea
CC308	8Wx8Dx8H	138.90 ea
CC310	10Wx10Dx10H	152.40 ea
CC312	12Wx12Dx12H	179.60 ea

e Square Accent Displays

Made with Durable PETG.

ITEM	DESCRIPTION	LIST PRICE
879-12	5Wx5Dx12H	\$34.00 ea
879-16	5Wx5Dx16H	43.30 ea
879-24	5Wx5Dx24H	53.90 ea

f Round Accent Displays

Made with Durable PETG.

ITEM	DESCRIPTION	LIST PRICE
872-12	4DIAx12H	\$43.30 ea
872-16	4DIAx16H	53.90 ea
872-24	4DIAx24H	64.70 ea



g Sloped Accent Displays

Made with Durable PETG.

ITEM	DESCRIPTION	LIST PRICE
1324-12	6DIAx12H	\$64.10 ea
1324-16	6DIAx16H	93.10 ea
1324-24	6DIAx24H	128.00 ea



Merchandising Displays



Mission Aluminum Ice Display

ITEM	DESCRIPTION	LIST PRICE
1563-2	12¾Wx12¾Dx11½H	\$227.30 ea
1563-3	15½Wx15½Dx20¼H	340.90 ea



Torre Redondo Glass Ice Display

ITEM	DESCRIPTION	LIST PRICE
1542-13	14DIAx12½H	\$227.30 ea



Torre Plaza Glass Ice Display

ITEM	DESCRIPTION	LIST PRICE
1541-3-13	16¾SQx20¼H	\$340.90 ea



2 and 3 Tier Bamboo Tray Wire Merchandiser

ITEM	DESCRIPTION	LIST PRICE
1290-2	18Wx15Dx15H	\$167.80 ea
1290-3	18Wx19Dx22H	219.40 ea

a Madera Merchandisers *New*

Shelves Adjustable to Sit Straight or Slanted.

ITEM	DESCRIPTION	LIST PRICE
3494-2-99	12Wx12Dx21H	\$230.00 ea
3494-3-99	12Wx12Dx31H	280.00 ea



b Madera Merchandiser *New*

Trays are Removable.

ITEM	DESCRIPTION	LIST PRICE
3448-99	16½Wx15½Dx12H	\$300.00 ea

c Square Wire Merchandisers

Includes Baskets.

ITEM	DESCRIPTION	LIST PRICE
1293-2	12Wx15Dx15H	\$131.70 ea
1293-3	12Wx19Dx20H	183.20 ea



d Trays and Baskets

ITEM	DESCRIPTION	LIST PRICE
1290TRAY	18Wx12D - Bamboo	\$54.20 ea
1291TRAY	18Wx12D - Wire	54.20 ea
1292TRAY	12" DIA Wire Basket	46.50 ea
1293TRAY	12" SQ Wire Basket	43.90 ea

e Round Wire Merchandisers

Includes Baskets.

ITEM	DESCRIPTION	LIST PRICE
1292-2	12Wx15Dx15H	\$140.70 ea
1292-3	12Wx18Dx22H	191.00 ea

f Rectangular Wire Merchandisers

Includes Baskets.

ITEM	DESCRIPTION	LIST PRICE
1291-2	18Wx15Dx15H	\$160.10 ea
1291-3	18Wx22Dx20H	214.20 ea



1293-3



1292-3



Bread Displays



Westport Bread Display Case

ITEM	DESCRIPTION	LIST PRICE
813-52	16½Wx15Dx15¾H	\$604.10 ea
813-52DRAWER	Replacement Drawer	58.10 ea



Bamboo Bread Display Case

ITEM	DESCRIPTION	LIST PRICE
1718-60	16½Wx15Dx15H	\$604.10 ea
C1718DRAWER	Replacement Drawer	58.10 ea



Squared Acrylic Bread Case

Black (13), Stainless Steel (55).

ITEM	DESCRIPTION	LIST PRICE
1614-13	7Wx12Dx20H	\$296.80 ea
1614-55	7Wx12Dx20H	337.50 ea
1204DRAWER	Replacement Drawer	30.80 ea



Midnight Bamboo Bread Case

ITEM	DESCRIPTION	LIST PRICE
813-96	15Wx14½Dx15H	\$604.10 ea
813-96DRAWER	Replacement Drawer	58.10 ea

a Madera Bread Case New

Can be Used Vertically or Horizontally.
Reclaimed Wood (99).

ITEM	DESCRIPTION	LIST PRICE
1204-99	8Wx13Dx20½H	\$258.00 ea
1204DRAWER	Replacement Bin	30.80 ea



b Eco Modern Bread Case

Two Each 2 Drawer Bread Boxes Included.

ITEM	DESCRIPTION	LIST PRICE
1279	14Wx11½Dx15H	\$374.60 ea
1480	Clear Replacement Bin	101.50 ea



c Eco Modern Merchandiser

Pieces Sold Individually or as a Set. Set Includes Frame, Bread Bin w/ Drawers, and Bin w/ Cover.

ITEM	DESCRIPTION	LIST PRICE
1471-SET	21Wx13Dx15H - Set	\$483.90 ea
1471	Frame	199.00 ea
1478	Bin with Cover	114.10 ea
1479	Replacement Bread Bin Drawers	177.60 ea



1478 Bin with Cover

1479 Bread Bin with Drawers

1471 Frame

d Soho Bread Case

Specify Color: Black (13), Silver (74).

ITEM	DESCRIPTION	LIST PRICE
1586	14Wx13Dx14¾H	\$290.90 ea
1586-13DRAWER	Replacement Drawer	71.50 ea
1586-74DRAWER	Replacement Drawer	71.50 ea

e One by One 4 Drawer Bread Case

Specify Color: Black (13), Silver (74).

ITEM	DESCRIPTION	LIST PRICE
1146	14Wx14¾Dx15¾H	\$291.50 ea



visit us online at: www.calmil.com **CAL·MIL** call toll-free 800-321-9069

Bread Displays



2 Tier Basket Bread Case

Inserts Have Hinged Tops for Freshness and Sanitation. Specify Color: Black (13), Chrome (49).

ITEM	DESCRIPTION	LIST PRICE
1203	14Wx17Dx21H	\$524.60 ea

Replacement Drawers

1203-BOTTOM	Replacement Bottom Bin	\$131.80 ea
1203-TOP	Replacement Top Bin	117.40 ea



Classic Acrylic Stackable Food Bin

ITEM	DESCRIPTION	LIST PRICE
992	7½Wx19½Dx8H	\$265.00 ea



Classic Acrylic Stackable Food Bin with Divider

Divider is Removable, Picture Shows 2 Stacked, Sold Individually.

ITEM	DESCRIPTION	LIST PRICE
948	11Wx14Dx12H	\$221.00 ea



Classic Acrylic Food Bin

ITEM	DESCRIPTION	LIST PRICE
944	7½Wx20Dx10½H	\$276.10 ea



Classic Acrylic Bulk Food Bin

ITEM	DESCRIPTION	LIST PRICE
999	7½Wx14Dx9H	\$209.80 ea



Classic Acrylic Food Bin with Knob

ITEM	DESCRIPTION	LIST PRICE
945	12½Wx12½Dx12½H	\$375.30 ea



Classic Acrylic Food Bin

ITEM	DESCRIPTION	LIST PRICE
943	12Wx16Dx12½H	\$330.90 ea



Classic Acrylic Divided Food Bin

ITEM	DESCRIPTION	LIST PRICE
123	13Wx16Dx7H	\$220.90 ea



Classic Acrylic Food Bin

ITEM	DESCRIPTION	LIST PRICE
272	10Wx10Dx5½H	\$92.10 ea

a Classic 3 Tier Bread Cases

Can be Used Vertically or Horizontally, Stackable.

ITEM	DESCRIPTION	LIST PRICE
1204	7Wx12Dx20H - Clear/Frost	\$163.50 ea
1204-12	7Wx12Dx20H - Clear	146.90 ea
1204-P	7Wx17Dx20H - Pullman Loaf	253.70 ea
1204P-12	7Wx17Dx20H - Pullman Loaf	226.80 ea

Replacement Drawers

1204DRAWER	1204 Drawer	\$30.80 ea
1204PDRAWER	1204-P Drawer	38.20 ea



b Urban Bread Display

Stackable. Stainless Steel (55).

ITEM	DESCRIPTION	LIST PRICE
3410-55	6¾Wx12¼Dx6¾H	\$164.80 ea

c Iron Bread Case

ITEM	DESCRIPTION	LIST PRICE
1720-3	7Wx12¼Dx19½H	\$226.40 ea
1720-4	13Wx12½Dx13H	293.10 ea
1204DRAWER	Replacement Drawer	30.80 ea

d Iron Display with Round Nose Bins

ITEM	DESCRIPTION	LIST PRICE
1280-2	15½Wx17¾Dx17½H	\$532.70 ea
1280-3	17½Wx16½Dx25H	732.60 ea
1281-2	20¼Wx19½Dx20½H	666.10 ea

Replacement Bins

C1280B	Replacement Bin for 1280	\$236.30 ea
C1281B	Replacement Bin for 1281	314.90 ea



e Classic 3 Tier Bread Case

Black (13), Westport (52).

ITEM	DESCRIPTION	LIST PRICE
1204-13	7Wx13Dx21H	\$205.70 ea
1204-52	8Wx13Dx21H	419.60 ea
1204DRAWER-13	Replacement Drawer	33.40 ea

f Nose Bin Display

Specify Color: Black (13), Stainless Steel (55), Bamboo (60).

ITEM	DESCRIPTION	LIST PRICE
3397-2	15½Wx17¾Dx15½H - 2 Tier	\$566.50 ea
3397-3	15Wx24Dx24¼H - 3 Tier	824.00 ea

Replacement Bins

C1280B	Replacement Bin for 1280	\$236.30 ea
C1281B	Replacement Bin for 1281	314.90 ea



Case Displays



Madera Bakery Display Case *New*

Includes 3 — 13" x 18" Clear Trays. Available in Attendant and Self Serve.

ITEM	DESCRIPTION	LIST PRICE
3432-99	21Wx21½Dx21½H - Attendant	\$700.00 ea
3432-S-99	21Wx21½Dx21½H - Self Serve	700.00 ea
3047	Chalkboard Tents	15.50 ea
325-13-12	Replacement Tray	36.50 ea



Madera Pastry Drawers

Sold Individually, Stackable. Liner Included.

ITEM	DESCRIPTION	LIST PRICE
3416	22Wx14½Dx9¼H	\$401.70 ea



284-S-60
Self Serve

Bamboo Bakery Display Case

Includes 3 — 13" x 18" Clear Trays. Available in Attendant and Self Serve.

ITEM	DESCRIPTION	LIST PRICE
284-60	21Wx16¼Dx22½H	\$1,040.60 ea
284-S-60	21Wx16¼Dx22½H	1,040.60 ea
325-13-12	Replacement Tray	36.50 ea



284-S-96

Midnight Bamboo Bakery Display Case

Includes 3 — 13" x 18" Black Trays. Available in Attendant and Self Serve.

ITEM	DESCRIPTION	LIST PRICE
284-96	21Wx16¼Dx22½H	\$1,040.60 ea
284-S-96	21Wx16¼Dx22½H	1,040.60 ea
325-13-13	Replacement Tray	42.20 ea

a Midnight Bamboo Euro Wood Case

Includes 3 — 10" x 14" Black Trays. Available in Attendant and Self Serve.

ITEM	DESCRIPTION	LIST PRICE
P255-96S	17Wx17Dx18H	\$857.80 ea
P255-96	17Wx17Dx18H	727.30 ea
335-10-13	Replacement Tray	39.00 ea



P255-96S

b Westport Display Cases

Includes 3 — 10" x 14" Clear Trays. Can be used as Attendant or Self-Serve.

ITEM	DESCRIPTION	LIST PRICE
814-52	17½Wx14Dx19¼H	\$594.50 ea
814-1-52	14Wx17½Dx19¼H	594.50 ea
335-10-12	Replacement Tray	32.50 ea



814-1-52



814-52

c Westport Display Case

Includes 3 — 13" x 18" Black Trays. Available in Attendant and Self Serve.

ITEM	DESCRIPTION	LIST PRICE
815-52	21Wx16¾Dx18¼H - Self Serve	\$910.60 ea
815-52A	21Wx16¾Dx18¼H	910.60 ea
325-13-13	Replacement Tray	42.20 ea



815-52
Self Serve



P255-52S

d Westport Euro Wood Trim Case

Includes 3 — 10" x 14" Black Trays. Available in Attendant and Self Serve.

ITEM	DESCRIPTION	LIST PRICE
P255-52S	17Wx17Dx18H	\$857.80 ea
P255-52	17Wx17Dx18H	727.30 ea
335-10-13	Replacement Tray	39.00 ea

e Westport Display Case

Includes 3 — 13" x 18" Black Trays. Available in Attendant and Self Serve.

ITEM	DESCRIPTION	LIST PRICE
284-52	21¾Wx18½Dx20¼H	\$1,040.60 ea
284-S-52	21¾Wx18½x20¼H	1,040.60 ea
325-13-13	Replacement Tray	42.20 ea



284-52



284-S-52
Self Serve

visit us online at: www.calmil.com **CAL·MIL** call toll-free 800-321-9069

Case Displays



1145-13

One by One Display Cases

Available in Self Serve and Attendant Serve.
Specify Color: Black (13), Silver (74).

ITEM	DESCRIPTION	LIST PRICE
1143	16½Wx14Dx22H - 10x14 Tray	\$508.40 ea
1143-S	16½Wx14Dx22H - 10x14 Tray	508.40 ea
1145	20½Wx17Dx22H - 13x18 Tray	576.20 ea
1145-S	20½Wx17Dx22H - 13x18 Tray	576.20 ea

Replacement Trays

Clear (12), Black (13).

335-10-12	Replacement 10x14 Tray	\$32.50 ea
335-10-13	Replacement 10x14 Tray	39.00 ea
325-13-12	Replacement 13x18 Tray	36.50 ea
325-13-13	Replacement 13x18 Tray	42.20 ea



3 Level Pastry Case

Includes Case and Set of 13" x 18" Trays.
Specify Color: Black (13), Platinum (39).

ITEM	DESCRIPTION	LIST PRICE
PC300	16Wx20Dx23H	\$1,023.70 ea



1574-74

Soho Display Case

Black Frame Includes 3 Black Trays and Silver Includes Clear Trays.

Specify Color: Black (13), Silver (74).

ITEM	DESCRIPTION	LIST PRICE
1574	17¼Wx12¾Dx20¾H-10x14 Trays	\$508.40 ea
1574-S	17¼Wx12¾Dx20¾H-Self Serve	508.40 ea
1575	21¼Wx15¾Dx20¾H-13x18 Trays	576.20 ea
1575-S	21¼Wx15¾Dx20¾H-Self Serve	576.20 ea

Replacement Trays

Clear (12), Black (13).

335-10-12	Replacement 10x14 Tray	\$32.50 ea
335-10-13	Replacement 10x14 Tray	39.00 ea
325-13-12	Replacement 13x18 Tray	36.50 ea
325-13-13	Replacement 13x18 Tray	42.20 ea



Luxe Step Display Case

Includes 3 — 13" x 18" White Trays.
Stainless Steel Trim (55).

ITEM	DESCRIPTION	LIST PRICE
3020-55	19Wx20Dx19H	\$576.20 ea
325-13-15	Replacement 13x18 Tray	42.20 ea



253-S Self Serve
268-S Self Serve



253
268

Aluminum Display Case

Specify Self-Serve or Attendant Serve.
Includes 3 Clear Trays.

ITEM	DESCRIPTION	LIST PRICE
253	18Wx11¾Dx17½H - 10x14 Trays	\$528.50 ea
253-S	18Wx11¾Dx17½H - 10x14 Trays	558.20 ea
268	13½Wx19¾Dx18½H - 13x18 Trays	675.50 ea
268-S	13½Wx19¾Dx18½H - 13x18 Trays	704.90 ea

Replacement Trays

335-10-12	Replacement 10x14 Tray	\$32.50 ea
325-13-12	Replacement 13x18 Tray	36.50 ea



P255-13

Iron Display Case

Includes 3 — 10" x 14" Clear Trays.
Specify Color: Black (13), Brown (48).

ITEM	DESCRIPTION	LIST PRICE
P255	16Wx16½Dx16½H	\$551.90 ea
335-10-12	Replacement Tray	32.50 ea

a 2 Level Pastry Case

Includes Case and Set Of Trays.
Specify Color: Black (13), Platinum (39).

ITEM	DESCRIPTION	LIST PRICE
PC200	20Wx16Dx16H	\$861.00 ea



b Self-Serve Iron Display Case

Includes 3 Clear Trays.

ITEM	DESCRIPTION	LIST PRICE
1708-1014	16Wx15Dx17½H - 10x14 Trays	\$519.50 ea
1708-1318	18Wx16Dx21H - 13x18 Trays	586.10 ea

Replacement Trays

335-10-12	Replacement 10x14 Tray	\$32.50 ea
325-13-12	Replacement 13x18 Tray	36.50 ea



c Iron Display Case

Straight Front for Self or Attendant Serve.
Includes 3 Clear Trays.

ITEM	DESCRIPTION	LIST PRICE
1735-1014	16Wx15Dx17½H - 10x14 Trays	\$519.50 ea
1735-1318	19Wx15Dx21¼H - 13x18 Trays	586.10 ea

Replacement Trays

335-10-12	Replacement 10x14 Tray	\$32.50 ea
325-13-12	Replacement 13x18 Tray	36.50 ea



d Urban Display Case

Includes 3 — 13" x 18" Clear Trays.
Stainless Steel (55).

ITEM	DESCRIPTION	LIST PRICE
3413-55	19¼Wx14¼Dx19¼H	\$536.60 ea
325-13-12	Replacement 13x18 Tray	36.50 ea

e Squared Bakery Display Case

Self Serve. Includes 3 Clear Trays.
Specify Color: Black (13), Stainless Steel (55).

ITEM	DESCRIPTION	LIST PRICE
1621-13	15¾Wx13Dx17¼H - 10x14 Trays	\$508.40 ea
1621-55	15¾Wx13Dx17¼H - 10x14 Trays	558.30 ea
1623-13	20¼Wx19¼Dx15H - 13x18 Trays	576.20 ea
1623-55	20¼Wx19¼Dx15H - 13x18 Trays	633.50 ea

Replacement Trays

335-10-12	Replacement 10x14 Tray	\$32.50 ea
325-13-12	Replacement 13x18 Tray	36.50 ea

f Iron Round Nose Bin Display

ITEM	DESCRIPTION	LIST PRICE
1280-2	15½Wx17¼Dx17½H	\$532.70 ea
1280-3	17½Wx16½Dx25H	732.60 ea
1281-2	20¼Wx19½Dx20½H	666.10 ea

Replacement Bins

C1280B	Replacement Bin for 1280	\$236.30 ea
C1281B	Replacement Bin for 1281	314.90 ea



g Glacier Display Case

Includes 3 — 10" x 14" Clear Trays.

ITEM	DESCRIPTION	LIST PRICE
1501-13	16Wx12Dx19H	\$594.50 ea
335-10-12	Replacement 10x14 Tray	32.50 ea

Case Displays



a Bistro Bakery Case

Includes 3 Square Trays and 3 Rectangle Trays. Grated Shelves are Adjustable to Sit Straight or Slanted for Self-Serve or Attendant Serve.

ITEM	DESCRIPTION	LIST PRICE
3419-13	23¼Wx13½Dx24¾H	\$1,854.00 ea
3047	Chalkboard Tents	15.50 ea

Replacement Trays

3414-15	6½Wx11½Dx1H	\$24.70 ea
3415-15	14Wx11½Dx1H	41.20 ea

b Classic Large Bakery Case

Ships Truck Only! Self-Serve.

Includes 6 — 13" x 18" Clear Trays.

ITEM	DESCRIPTION	LIST PRICE
288	27Wx23Dx28H	\$2,144.00 ea
325-13-12	Replacement Tray	36.50 ea



c Classic Attendant Serve Case

Includes 3 — 18" x 26" Clear Trays.

ITEM	DESCRIPTION	LIST PRICE
1202	27Wx20Dx20H	\$1,014.10 ea
P235-12	Replacement Tray	55.10 ea

d Classic Self-Serve Display Case

Includes 3 — 18" x 26" Clear Trays.

ITEM	DESCRIPTION	LIST PRICE
1202-S	27Wx20Dx20H	\$1,014.10 ea
P235-12	Replacement Tray	55.10 ea



a Classic Display Case

Ships Truck Only! Large Slanted Front. Self-Serve. Includes 3 — 18" x 26" Clear Trays.

ITEM	DESCRIPTION	LIST PRICE
P254SS	26½Wx22½Dx23½H	\$1,249.50 ea
P235-12	Replacement Tray	55.10 ea



b Classic Display Case

Ships Truck Only! Slanted Front. Double Rear Doors. Includes 3 — 18" x 26" Clear Trays.

ITEM	DESCRIPTION	LIST PRICE
P254	26½Wx22½Dx23½H	\$1,249.50 ea
P235-12	Replacement Tray	55.10 ea



c Nose Bin Displays

Specify Color: Black (13), Stainless Steel (55), or Bamboo (60).

ITEM	DESCRIPTION	LIST PRICE
3397-2	15½Wx17¾Dx15½H	\$566.50 ea
3397-3	15Wx24Dx24¾H	824.00 ea

Replacement Bins

C1280B	Replacement Bin for 1280	\$236.30 ea
C1281B	Replacement Bin for 1281	314.90 ea



d Grand Bakery Case *New*

Small Case Includes 3 Small Trays, 3 Large Trays. Large Case Includes 6 Small Trays and 3 Large Trays. Assembly Required.

ITEM	DESCRIPTION	LIST PRICE
3493-13L	29Wx17Dx29H	\$1,385.25 ea
3493-13S	20Wx15½Dx21H	760.00 ea
3047	Chalkboard Tents	15.50 ea

Replacement Trays

3414-15	6½Wx11½Dx1H	\$24.70 ea
3415-15	14Wx11½Dx1H	41.20 ea



Black (13)



Stainless Steel (55)



Bamboo (60)

3397-3-60

visit us online at: www.calmil.com **CAL·MIL** call toll-free 800-321-9069

Case Displays



Classic Display Case

Slant Front Doors. Self Serve.
Includes 3 — 13" x 18" Clear Trays.

ITEM	DESCRIPTION	LIST PRICE
P241SS	19Wx17Dx18H	\$572.40 ea

Bin/Case Topper (For P241 & P241SS)

1201	18½Wx13Dx6H	\$220.40 ea
------	-------------	-------------



Classic Display Case

Slant Front. Rear Door.
Includes 3 — 10" x 14" Clear Trays.

ITEM	DESCRIPTION	LIST PRICE
261	15½Wx15Dx16H	\$429.30 ea
335-10-12	Replacement Tray	32.50 ea



Classic Display Case

Slant Front. Rear Door and Self Serve Front Door.

ITEM	DESCRIPTION	LIST PRICE
241-S	13½Wx22Dx21H - 13x18	\$572.40 ea
263-S	11½Wx17Dx17H - 10x14	429.30 ea

Replacement Trays

325-13-12	Replacement 13x18 Tray	\$36.50 ea
335-10-12	Replacement 10x14 Tray	32.50 ea



Classic Display Case

Rear Double Doors. Attendant Serve.
Includes: 3 — 13" x 18" Clear Trays.

ITEM	DESCRIPTION	LIST PRICE
P241	19Wx16½Dx16H	\$572.40 ea



Classic Display Case

Slant Front and Rear Door.
Includes 2 — 10" x 14" Clear Trays.

ITEM	DESCRIPTION	LIST PRICE
254	15Wx13Dx11H	\$270.10 ea
335-10-12	Replacement Tray	32.50 ea



Classic Display Case

Slant Front. Rear Door.

ITEM	DESCRIPTION	LIST PRICE
241	13½Wx22Dx21H-13x18	\$561.90 ea
260	11½Wx17Dx17H-10x14	408.50 ea

Replacement Trays

325-13-12	Replacement 13x18 Tray	\$36.50 ea
335-10-12	Replacement 10x14 Tray	32.50 ea



Classic Display Case

Slant Front. Front Door.
Includes 2 — 13" x 18" Clear Trays.

ITEM	DESCRIPTION	LIST PRICE
255-S	19Wx15Dx11H	\$347.30 ea
325-13-12	Replacement Tray	36.50 ea



Classic Display Case

3 Front Self-Serve Doors. Rear Door.
Includes 3 — 13" x 18" Clear Trays.

ITEM	DESCRIPTION	LIST PRICE
124	13½Wx20Dx18H	\$572.40 ea
325-13-12	Replacement Tray	36.50 ea



Classic Display Case

Slant Front. Rear Door.
Includes 2 — 13" x 18" Clear Trays.

ITEM	DESCRIPTION	LIST PRICE
255	19Wx15Dx11H	\$347.30 ea
325-13-12	Replacement Tray	36.50 ea

a Classic Display Case

Slant Front. Rear Door.
Includes 2 — 280-T Trays.

ITEM	DESCRIPTION	LIST PRICE
280	10Wx10Dx11H	\$173.80 ea
280-T	Replacement Tray	29.90 ea



b Classic Display Case

Slant Front. Includes 2 Drawers.

ITEM	DESCRIPTION	LIST PRICE
258	10¼Wx18½Dx14H	\$194.40 ea



c Classic Display Case

Slant Front. Rear Door.
Includes 3 — 280-T Trays.

ITEM	DESCRIPTION	LIST PRICE
P257	10Wx15Dx13½H	\$235.10 ea
280-T	Replacement Tray	29.90 ea



d Tongs Kit

Includes Tongs, Chain, Hook & Tape.

ITEM	DESCRIPTION	LIST PRICE
267	Tongs Kit	\$26.90 ea



e Elite Case

3 Tray Unit — 9½" W with Tray
Depths of 11½", 13", & 15½".

ITEM	DESCRIPTION	LIST PRICE
1505-3	12Wx17Dx14½H	\$447.10 ea



f Stackable Display Case

Includes 13" x 18" Clear Tray.

ITEM	DESCRIPTION	LIST PRICE
920	18½Wx14Dx6H	\$278.60 ea
921	18½Wx14Dx10H	428.20 ea
325-13-12	Replacement Tray	36.50 ea



920



921

visit us online at: www.calmil.com **CAL·MIL** call toll-free 800-321-9069

Case Displays



Industrial Display Case *New*

Includes 3 — 13" x 18" Clear Trays.

ITEM	DESCRIPTION	LIST PRICE
3503-1318	20½Wx17Dx22H	\$576.20 ea
325-13-12	Replacement Tray	36.50 ea



289



1019

Classic Euro Display Cases

Euro Front. Rear Door.
Includes 10" x 14" Clear Trays.

ITEM	DESCRIPTION	LIST PRICE
289	15½Wx13Dx11H-(2) 10x14 Trays	\$327.00 ea
P255	15½Wx17Dx16¼H-(3) 10x14 Trays	449.50 ea
1019	15½Wx12Dx7H-(1) 10x14 Tray	220.40 ea
335-10-12	Replacement Tray	32.50 ea



P255



Classic Display Case

Straight Front. One Door.
Includes 3 – 10" x 14" Clear Trays.

ITEM	DESCRIPTION	LIST PRICE
257	11Wx15½Dx17H	\$449.50 ea
335-10-12	Replacement Tray	32.50 ea



Classic Cake/Pie Case

Hexagon Front. Rear Door.
Includes 12" x 12" Shelves.

ITEM	DESCRIPTION	LIST PRICE
252	13Wx12½Dx21½H	\$367.90 ea



a Classic Display Case – U-Build

Self-Serve and Attendant Serve Available.
Includes 4 – 13" x 18" Clear Trays.
Assembly Required.

ITEM	DESCRIPTION	LIST PRICE
1012	13½Wx21Dx24½H	\$381.70 ea
1012-S	13½Wx21Dx24½H	405.30 ea
325-13-12	Replacement Tray	36.50 ea



1012

a



1012-S Self-Serve

b Classic Display Case – U-Build

Self-Serve and Attendant Serve Available.
Includes 3 – 13" x 18" Clear Trays.
Assembly Required.

ITEM	DESCRIPTION	LIST PRICE
1011	19½Wx17Dx16½H	\$305.50 ea
1011-S	19½Wx17Dx16½H	320.20 ea
325-13-12	Replacement Tray	36.50 ea



1011

b



1011-S Self-Serve

c Classic Display Case – U-Build

Self-Serve. Includes 3 Clear Trays.
Assembly Required.

ITEM	DESCRIPTION	LIST PRICE
942-S	13½Wx22Dx21H - 13x18 Tray	\$529.80 ea
963-S	11½Wx17Dx17H - 10x14 Tray	419.30 ea
325-13-12	Replacement Tray - 13x18	36.50 ea
335-10-12	Replacement Tray - 10x14	32.50 ea



942-S 13" x 18" Self-Serve
963-S 10" x 14" Self-Serve

d



941 13" x 18"
960 10" x 14"

d Classic Display Case – U-Build

Attendant Serve.
Includes 3 Clear Trays.
Assembly Required.

ITEM	DESCRIPTION	LIST PRICE
941	13½Wx22Dx21H-13x18 Tray	\$507.90 ea
960	11½Wx17Dx17H-10x14 Tray	397.20 ea

Replacement Trays

325-13-12	Replacement 13x18 Tray	36.50 ea
335-10-12	Replacement 10x14 Tray	32.50 ea

Mirror & Serving Stones



Octagon Mirror Tray with Black Trim

ITEM	DESCRIPTION	LIST PRICE
RR161	16DIAx1H	\$191.00 ea
RR241	24DIAx1H	384.20 ea



Rectangular Mirror Tray with Black Trim

ITEM	DESCRIPTION	LIST PRICE
RR243	24Wx18Dx1H	\$359.30 ea
RR323	24Wx32Dx1H	518.60 ea
RR403	28Wx40Dx1H	623.70 ea



Oval Mirror Tray with Black Trim

ITEM	DESCRIPTION	LIST PRICE
RR242	24Wx18Dx1H	\$347.90 ea
RR322	24Wx32Dx1H	483.60 ea
RR402	28Wx40Dx1H	623.80 ea



Round Mirror Tray with Black Trim

ITEM	DESCRIPTION	LIST PRICE
RR150	15DIAx1H	\$142.30 ea
RR240	24DIAx1H	384.20 ea
RR320	32DIAx1H	580.70 ea



Ying Yang 2 Piece Mirror Set

ITEM	DESCRIPTION	LIST PRICE
PT155	15DIAx3/4H	\$257.60 ea
PT185	18DIAx3/4H	333.20 ea
PT245	24DIAx3/4H	420.30 ea
PT325	32DIAx3/4H	544.70 ea

a Oval Mirror Tray

ITEM	DESCRIPTION	LIST PRICE
PT242	18Wx24Dx 1/4H	\$259.90 ea
PT322	24Wx32Dx1/4H	361.50 ea
PT402	28Wx40Dx1/4H	459.80 ea



b Octagon Mirror Tray

ITEM	DESCRIPTION	LIST PRICE
716-12	12DIAx1/4H	\$66.80 ea
PT151	15DIAx1/4H	118.60 ea
PT241	24DIAx1/4H	300.60 ea
PT321	32DIAx1/4H	488.10 ea



c Rectangular Mirror Trays

ITEM	DESCRIPTION	LIST PRICE
PT243	18Wx24Dx1/4H	\$259.90 ea
PT323	24Wx32Dx1/4H	361.50 ea
PT403	28Wx40Dx1/4H	459.80 ea
PT450	12 1/2 Wx20 1/2 D x 1/2 H	161.60 ea



d Round Mirror Trays

ITEM	DESCRIPTION	LIST PRICE
414-10	10DIAx1/4H	\$51.30 ea
414-12	12DIAx1/4H	61.70 ea
414-16	16DIAx1/4H	98.20 ea
414-24	24DIAx1/4H	224.30 ea
414-32	32DIAx1/4H	428.40 ea

e Round Glass Mirror Tray

ITEM	DESCRIPTION	LIST PRICE
GT12	12DIAx1/4H	\$44.10 ea



f 24 Piece Round Mirror Kit

ITEM	DESCRIPTION	LIST PRICE
GT1288	24 Piece Kit	\$959.20 ea

g Small Square Mirror Tray

ITEM	DESCRIPTION	LIST PRICE
PT253	7 1/2 W x 7 1/2 D x 1/4 H	\$56.40 ea
411-12	12 W x 12 D x 1/2 H	61.70 ea
411-16	16 W x 16 D x 1/2 H	98.20 ea
411-24	24 W x 24 D x 1/2 H	224.30 ea



Mirror & Serving Stones



a Offset Circle 3 Tier Mirror Riser

ITEM	DESCRIPTION	LIST PRICE
MT220	21DIAx19½H	\$841.70 ea

b Large 3 Tier Mirror Riser

ITEM	DESCRIPTION	LIST PRICE
MT100	32¼Wx13¼Dx19½H	\$841.70 ea



c Round 3 Tier Mirror Riser

ITEM	DESCRIPTION	LIST PRICE
MT240	24DIAx18¾H	\$841.70 ea
MT300	30½DIAx24¾H	1,020.30 ea

d Metal 3 Tier Simulated Stone Riser
Black Pearl (31).

ITEM	DESCRIPTION	LIST PRICE
SS800-31	20Wx30Dx18H	\$831.60 ea



e Simulated Stone Multi-Level Riser

Black Pearl (31).

ITEM	DESCRIPTION	LIST PRICE
DE1030-31	18Wx18Dx8½H	\$449.60 ea



f Rectangular Serving Stone Trays

Specify Color: Grey (30), Black Pearl (31).

ITEM	DESCRIPTION	LIST PRICE
SS353	22Wx35Dx1/2H	\$590.90 ea



g Rectangular Quarry Serving Stone Trays

Specify Color: Grey (30), Black Pearl (31).

ITEM	DESCRIPTION	LIST PRICE
SS3039	23Wx30Dx1/2H	\$506.10 ea

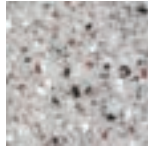

Grey (30)



h Square Quarry Serving Stone Trays

Specify Color: Grey (30), Black Pearl (31).

ITEM	DESCRIPTION	LIST PRICE
SS2289	22Wx22Dx1/2H	\$421.50 ea



Black Pearl (31)



i Round Black Pearl Simulated Stone Trays

Black Pearl (31).

ITEM	DESCRIPTION	LIST PRICE
SS150-31	15DIAx1/2H	\$180.80 ea
SS230-31	23DIAx1/2H	460.90 ea
SS290-31	39DIAx1/2H	674.50 ea



j Oval Simulated Stone Tray

Specify Color: Grey (30), Black Pearl (31).

ITEM	DESCRIPTION	LIST PRICE
SS312	31Wx19Dx1/2H	\$506.10 ea



k Black Ice X-Stone Trays

ITEM	DESCRIPTION	LIST PRICE
125-31	15Wx15Dx1/2H	\$267.80 ea
126-31	24Wx16Dx1/2H	449.50 ea
127-31	15Wx12Dx1/2H	214.70 ea
129-31	30Wx18Dx1/2H	644.40 ea

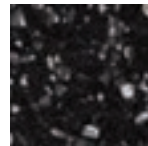

Black Ice (31)



125-31



126-31



127-31



129-31

Cutting Boards & Carving



3037-55

Stainless Steel Carving Station

Maple Cutting Board. Heat Lamp Included.

ITEM	DESCRIPTION	LIST PRICE
3037-55	20Wx16Dx4H	\$1,081.50 ea
3495	Replacement Lamp	700.00 ea



Maple Carving Station w/ Lamp *New*

Heat Lamp Included.

ITEM	DESCRIPTION	LIST PRICE
3490-71	20Wx24Dx1½H	\$925.00 ea
3495	Replacement Lamp	700.00 ea



Cutting Boards

Specify Color: Black (13), Natural Wood (14).

ITEM	DESCRIPTION	LIST PRICE
3337-612	6Wx12Dx½H	\$23.10 ea
3337-1218	12Wx18Dx½H	68.60 ea
3337-1520	15Wx20Dx½H	101.80 ea
3337-1824	18Wx24Dx½H	133.90 ea



Lightwood (53)



Westport (52)



Cut-Mate® High Heat Carving Station

Specify Color: Westport (52), Lightwood (53).

ITEM	DESCRIPTION	LIST PRICE
810*	22Wx18Dx4H	\$587.60 ea

*Note: High Heat Board Maximum Temperature 325°F.
Black Tray Maximum Temperature 180°F.
Accommodates Most Standard Heat Lamps.

a Rounded Serving Boards

Can Withstand up to 350° F.
Black (13), Natural (14).

ITEM	DESCRIPTION	LIST PRICE
1531-612-13	12Wx6Dx¼H	\$14.80 ea
1531-612-14	12Wx6Dx¼H	12.50 ea
1531-616-13	16Wx6Dx¼H	20.50 ea
1531-616-14	16Wx6Dx¼H	19.30 ea



b Serving Boards with Handle

Can Withstand up to 350° F.
Black (13), Natural (14).

ITEM	DESCRIPTION	LIST PRICE
1535-12-13	11¾Wx8Dx¼H	\$21.60 ea
1535-12-14	11¾Wx8Dx¼H	20.50 ea
1535-16-13	15¾Wx8Dx¼H	26.20 ea
1535-16-14	15¾Wx8Dx¼H	25.00 ea
1535-24-13	23¾Wx8Dx¼H	35.20 ea
1535-24-14	23¾Wx8Dx¼H	34.10 ea



c Flat Serving Boards

Can Withstand up to 350° F.
Black (13), Natural (14).

ITEM	DESCRIPTION	LIST PRICE
1530-616-13	16Wx6Dx¼H	\$20.50 ea
1530-616-14	16Wx6Dx¼H	19.30 ea



Custom Sizes and Shapes Available Upon Request.



visit us online at: www.calmil.com **CAL·MIL** call toll-free 800-321-9069

Serving Boards



Oval Board with Cutout Handle

Oak (21), Walnut (78).

ITEM	DESCRIPTION	LIST PRICE
3042-21	16Wx8Dx¾H	\$49.40 ea
3042-78	16Wx8Dx¾H	61.80 ea



Oak and Walnut Boards

Oak (21), Walnut (78).

ITEM	DESCRIPTION	LIST PRICE
3043-21	12Wx9Dx¾H	\$49.40 ea
3043-78	12Wx9Dx¾H	61.80 ea



Write-On Boards with Handle

Bamboo (60), Maple (71), Walnut (78).

ITEM	DESCRIPTION	LIST PRICE
3040-60	17Wx9Dx¾H	\$61.80 ea
3040-71	17Wx9Dx¾H	49.40 ea
3040-78	17Wx9Dx¾H	82.40 ea
3062-15	White Chalkboard Pen	12.40 ea



Natural Edged Boards

Oak (21), Walnut (78).

ITEM	DESCRIPTION	LIST PRICE
3041-21	16Wx9Dx¾H	\$49.40 ea
3041-78	16Wx9Dx¾H	61.80 ea



a



b

a Oak Burger Board *New*

ITEM	DESCRIPTION	LIST PRICE
3496-1111-21	11Wx11Dx¾H	\$46.00 ea
3441-55	Stainless Steel French Fry Holder	14.00 ea
3484-15	White Melamine Ramekin	2.50 ea

b Maple Steak Serving Board *New*

ITEM	DESCRIPTION	LIST PRICE
3496-1111-71	11Wx11Dx1½H	\$52.00 ea
3600-65M	Faux Slate French Fry Crock	10.00 ea



c

c Round Walnut Board

ITEM	DESCRIPTION	LIST PRICE
3044-12-78	12DIAx2H	\$123.60 ea

d Round/Oval Walnut Boards

ITEM	DESCRIPTION	LIST PRICE
3052-78	12DIAx¾H	\$61.80 ea
3053-78	12Wx8Dx¾H	61.80 ea



3052-78



3053-78



d

visit us online at: www.calmil.com **CAL·MIL** call toll-free 800-321-9069

Slate



Slate Serving/Display Stones Black (65).

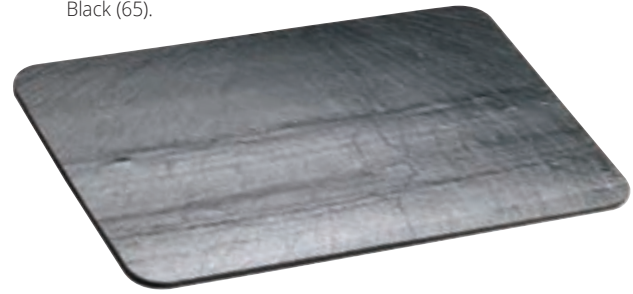

ITEM	DESCRIPTION	LIST PRICE
1522-1014-65	10Wx14Dx¼H	\$50.10 ea



ITEM	DESCRIPTION	LIST PRICE
1522-712-65	7Wx12Dx¼H	\$42.50 ea
1522-518-65	5Wx18Dx¼H	52.30 ea

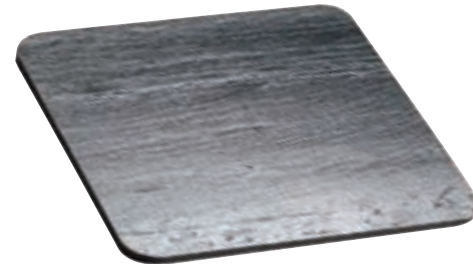

ITEM	DESCRIPTION	LIST PRICE
1522-1212-65	12Wx12Dx¼H	\$55.10 ea



ITEM	DESCRIPTION	LIST PRICE
1522-44-65	4Wx4Dx¼H	\$16.20 ea



ITEM	DESCRIPTION	LIST PRICE
1522-1020-65	10Wx20Dx¼H	\$84.00 ea

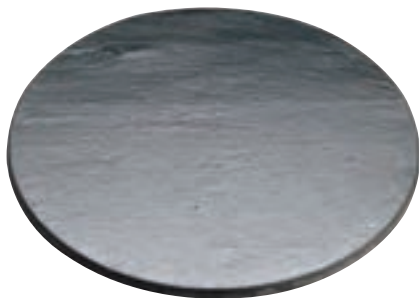

ITEM	DESCRIPTION	LIST PRICE
1523-12-65	12DIAx¼H	\$95.00 ea

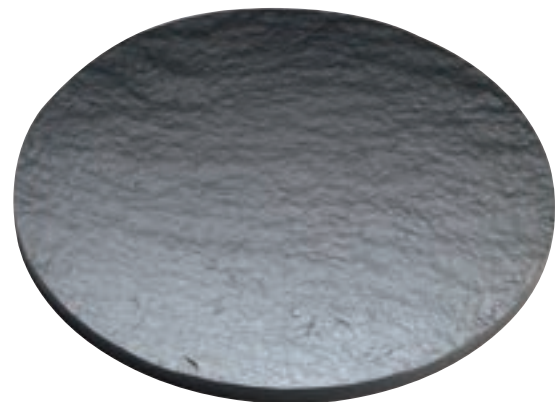

ITEM	DESCRIPTION	LIST PRICE
1523-15-65	15DIAx¼H	\$130.00 ea



Faux Cement Serving Boards *New*

Constructed of Durable Melamine.

ITEM	DESCRIPTION	LIST PRICE
1522-518-77	5Wx18Dx¼H - Rectangle	\$32.00 ea
1522-712-77	7Wx12Dx¼H - Rectangle	29.00 ea
1522-1014-77	10Wx14Dx¼H - Rectangle	42.00 ea
1522-1020-77	10Wx20Dx¼H - Rectangle	60.00 ea
1522-1212-77	12Wx12Dx¼H - Square	42.00 ea
3502-12-77	12DIAx¼H - Round	42.00 ea
3502-15-77	15DIAx¼H - Round	60.00 ea

visit us online at: www.calmil.com **CAL·MIL** call toll-free 800-321-9069

Faux Slate

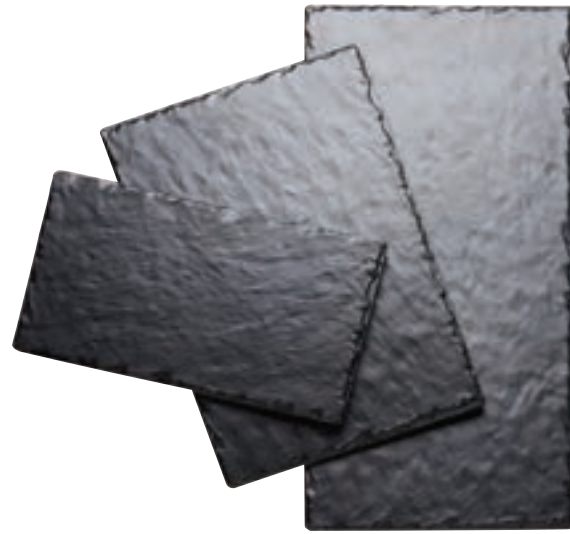

Faux Slate Platters *New*

Constructed of Durable Black Melamine.

ITEM	DESCRIPTION	LIST PRICE
SR252-65M	11½Wx11½Dx1H - Square	\$32.00 ea
3459-1515-65M	15Wx15Dx1H - Square	60.00 ea
3459-137-65M	13Wx7Dx1H - Rectangle	25.00 ea
3459-1310-65M	13Wx10Dx1H - Rectangle	34.00 ea
3459-217-65M	21Wx7Dx1H - Rectangle	40.00 ea
3459-2113-65M	21Wx13Dx1H - Rectangle	65.00 ea

Faux Slate Serving Boards *New*

Constructed of Durable Black Melamine.

ITEM	DESCRIPTION	LIST PRICE
1522-518-65M	5Wx18Dx¼H - Rectangle	\$32.00 ea
1522-712-65M	6¾Wx12Dx¼H - Rectangle	29.00 ea
1522-1014-65M	10Wx14Dx¼H - Rectangle	42.00 ea
1522-1020-65M	10Wx20Dx¼H - Rectangle	60.00 ea
1522-1212-65M	12Wx12Dx¼H - Square	42.00 ea
3502-12-65M	12DIx¼H - Round	42.00 ea
3502-15-65M	15DIx¼H - Round	60.00 ea



Round Frames *New*

Faux Cement and/or Faux Slate Platters Sold Separately. Stacking Brackets Do Not Fit Round Frames.

ITEM	DESCRIPTION	LIST PRICE
3486-12-13	12DIAx3¼H	\$80.00 ea
3486-15-13	15DIAx3¼H	84.00 ea

Faux Cement/Slate Inserts

Specify Color: Faux Slate (65M), Faux Cement (77).

3502-12	12DIAx¼H	\$42.00 ea
3502-15	15DIAx¼H	60.00 ea



Square Frames *New*

Faux Cement and/or Faux Slate Platters Sold Separately. Stacking Brackets Sold Separately.

ITEM	DESCRIPTION	LIST PRICE
3487-1212-13	12Wx12Dx3¼H	\$80.00 ea

Faux Cement/Slate Inserts

Specify Color: Faux Slate (65M), Faux Cement (77).

1522-1212	12Wx12Dx¼H	\$42.00 ea
-----------	------------	------------



Rectangle Frames *New*

Faux Cement and/or Faux Slate Platters Sold Separately. Stacking Brackets Sold Separately.

ITEM	DESCRIPTION	LIST PRICE
3487-1014-13	10Wx14Dx3¼H	\$80.00 ea
3487-1020-13	10Wx20Dx3¼H	80.00 ea

Faux Cement/Slate Inserts

Specify Color: Faux Slate (65M), Faux Cement (77).

1522-1014	10Wx14Dx¼H	\$42.00 ea
1522-1020	10Wx20Dx¼H	60.00 ea

Stacking Brackets for 3487 Series *New*

Includes 2 Brackets. Works for 3487 Series Only, Not on Round 3486 Frames.

ITEM	DESCRIPTION	LIST PRICE
3487-13BRACKET	7H - Pair of Brackets	\$55.00 ea



Tabletop



Round Serving Trays *New*

ITEM	DESCRIPTION	LIST PRICE
1523-12-65	12DIA - Slate	\$95.00 ea
3502-12-65M	12DIA - Faux Slate	42.00 ea
1523-12-77	12DIA - Faux Cement	42.00 ea



Rectangular Faux Slate Serving Tray *New*

ITEM	DESCRIPTION	LIST PRICE
1522-712-65M	7Wx12Dx¼H	\$29.00 ea



Rectangular Slate Serving Tray *New*

ITEM	DESCRIPTION	LIST PRICE
1522-712-65	7Wx12Dx¼H	\$42.50 ea



3501-65M

3501-77



Faux Slate Square Platter *New*

ITEM	DESCRIPTION	LIST PRICE
SR252-65M	11½Wx11½Dx1H	\$32.00 ea

Melamine Enamelware Tray *New*

ITEM	DESCRIPTION	LIST PRICE
3463-15	13Wx9Dx1H	\$25.00



Faux Cement Serving Tray *New*

ITEM	DESCRIPTION	LIST PRICE
1522-712-77	7Wx12Dx¼H	\$29.00 ea



Faux Cement/Slate Taster Trays *New*

Ramekins and Crock Sold Separately.
Specify Color: Faux Slate (65M), Faux Cement (77).



3500-77

ITEM	DESCRIPTION	LIST PRICE
3500	11¾Wx5Dx¾H	\$26.00 ea

Faux Slate/Cement Taster Flights *New*

2.25" Cut-Outs for Glasses (Sold Separately).
Specify Color: Faux Slate (65M), Faux Cement (77).

ITEM	DESCRIPTION	LIST PRICE
3501	11¾Wx3¾Dx¾H	\$24.00 ea

a Stainless Steel French Fry Holder *New*

ITEM	DESCRIPTION	LIST PRICE
3441-55	4½Wx2½Dx3¾H	\$14.00 ea



b Faux Slate French Fry Holder *New*

ITEM	DESCRIPTION	LIST PRICE
3441-65M	4½Wx2½Dx3¾H	\$10.00 ea

c Concave French Fry Holder *New*

Constructed of Faux Slate Melamine.

ITEM	DESCRIPTION	LIST PRICE
3600-65M	4¾DIAx4¾H	\$10.00 ea

d Basket Side Servers *New*

ITEM	DESCRIPTION	LIST PRICE
3442-4	4Wx4Dx3H	\$13.00 ea
3442-5	5Wx5Dx3H	16.00 ea



e Cone Wire French Fry Holder *New*

ITEM	DESCRIPTION	LIST PRICE
3468	5Wx10½H	\$21.00 ea



f Round Basket Side Server *New*

ITEM	DESCRIPTION	LIST PRICE
3443	3¾DIAx3¾H	\$14.00 ea



g Enamelware French Fry Server *New*

Constructed of Melamine.

ITEM	DESCRIPTION	LIST PRICE
3462-15	3¾DIAx5H	\$9.00 ea

h Wire Taco Stands *New*

ITEM	DESCRIPTION	LIST PRICE
3476-2	2½Wx4½Dx1¾H - 2 Tacos	\$12.00 ea
3476-3	2½Wx6½Dx1¾H - 3 Tacos	16.00 ea

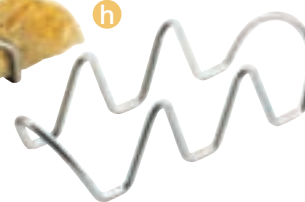

i Stainless Steel Taco Stand *New*

Holds 2-3 Tacos.

ITEM	DESCRIPTION	LIST PRICE
3479-55	7Wx3Dx2H	\$16.00 ea



j Enamelware Side Dish Bowls *New*

Constructed of Melamine.

ITEM	DESCRIPTION	LIST PRICE
3467-4-15	4½DIAx1¾H	\$6.00 ea
3467-5-15	5½DIAx2H	12.00 ea



k Melamine Ramekins *New*

Specify Color: Black (13) or White (15).

ITEM	DESCRIPTION	LIST PRICE
3484	2¾DIAx1½H	\$2.50 ea



Condiment & Packet Displays



One by One Jar Display

Glass Jars Included.
Colors: Black (13), Silver (74).

ITEM	DESCRIPTION	LIST PRICE
1149	6¼Wx13¼Dx11½H	\$115.80 ea



Extra Jars and Lids

ITEM	DESCRIPTION	LIST PRICE
C4X4GLCN	4Wx4D - Glass Jar	\$19.50 ea
C1432BODY	4Wx4D - White Melamine Jar	14.80 ea
C4X4-60	4Wx4D - Bamboo Bin	18.90 ea
C4X4-96	4Wx4D - Midnight Bamboo Bin	18.90 ea

ITEM	DESCRIPTION	LIST PRICE
1807	S/S Hinge Lid for C4X4GLCN	\$10.50 ea
1807-N	S/S Notched Hinge Lid for C4X4GLCN	10.50 ea
1811	Plastic Hinge Lid for C4X4GLCN	7.30 ea
1811-N	Plastic Notched Lid for C4X4GLCN	7.30 ea
C1432LID	Lid for 4x4 Melamine Jar	11.30 ea
C1432NL	Notched Lid for C1432BODY	11.30 ea

1807

1811



Iron Jar Display

Specify Color: Black (13), Chrome (49).

ITEM	DESCRIPTION	LIST PRICE
1803-4	4Wx12Dx10½H	\$102.50 ea



Squared 3 Jar Display

Black (13), Stainless Steel (55).

ITEM	DESCRIPTION	LIST PRICE
1604-13	4Wx12Dx10½H	\$125.00 ea
1604-55	4Wx12Dx10½H	159.00 ea



Bamboo/Midnight Bamboo Jar Display

Glass Jars Included.
Colors: Bamboo (60), Midnight Bamboo (96).

ITEM	DESCRIPTION	LIST PRICE
1486	5Wx14Dx13H - Bamboo	\$149.90 ea
1486-96	5Wx14Dx13H - Midnight Bamboo	149.90 ea

a Luxe Stair Step Jar Display

Stainless Steel (55).

ITEM	DESCRIPTION	LIST PRICE
3003-55-12	4½Wx12¼Dx9H - Glass Jars	\$125.00 ea
3003-55-15	4½Wx12¼Dx9H - Melamine Jars	133.90 ea

b Luxe 9 Bin/Jar Condiment Display

Stainless Steel Trim (55).

ITEM	DESCRIPTION	LIST PRICE
3018-55-12	12¼Wx9Dx15½H - Glass Jars	\$299.90 ea
3018-55-15	12¼Wx9Dx15½H - Melamine Jars	321.40 ea

c Eco Modern 9 Jar Stand 

Glass Jars Not Included.

ITEM	DESCRIPTION	LIST PRICE
1474	14Wx13½Dx7¼H	\$152.10 ea
C4X4GLCN	Glass Jar	19.50 ea

d Mission Jar Display 

Specify Color: Black (13), Platinum (39).

ITEM	DESCRIPTION	LIST PRICE
1723	14Wx9Dx7H	\$159.80 ea

e Iron 9 Glass Jar Display 

Specify Color: Black (13), Platinum (39).

ITEM	DESCRIPTION	LIST PRICE
1812	13Wx9½Dx17½H	\$258.00 ea

f Midnight Bamboo Iron 9 Jar Bin Display 

ITEM	DESCRIPTION	LIST PRICE
1817-96	13Wx9½Dx17½D	\$258.00 ea

g Bamboo Iron 9 Bin Display 

Specify Frame Color: Black (13), Platinum (39).

ITEM	DESCRIPTION	LIST PRICE
1817	13Wx9½Dx17½H	\$258.00 ea



Condiment & Packet Displays



Iron Jar Display BPA FREE

Glass Jars Included. Lids Sold Separately.
Specify Color: Black (13), Platinum (39).

ITEM	DESCRIPTION	LIST PRICE
1809	14Wx9Dx7H	\$158.60 ea



Iron Glass Jar Display BPA FREE

Includes 3 Glass Jars. Black (13).

ITEM	DESCRIPTION	LIST PRICE
1804-13	12½Wx11Dx13H	\$91.20 ea



Coffee and Tea Condiment Stair Step

Includes 4 (4x8) Glass Jars.

ITEM	DESCRIPTION	LIST PRICE
3338-13	18Wx9Dx17H	\$428.50 ea



Iron Iced Jar Display BPA FREE

Glass Jars Included.
Specify Color: Black (13), Platinum (39).

ITEM	DESCRIPTION	LIST PRICE
1806-5	13½Wx5½Dx7H	\$92.20 ea
1806-7	13½Wx5½Dx9H	92.20 ea



Aluminum Jar Riser BPA FREE

Glass Jars Included.

ITEM	DESCRIPTION	LIST PRICE
1560-2	12Wx4¼Dx2H	\$159.00 ea
1560-4	12Wx4¼Dx4H	159.00 ea

a Madera Single Jar Risers New

Includes Glass Jar. Reclaimed Wood (99).

ITEM	DESCRIPTION	LIST PRICE
3427-3-99	4¼Wx4¼D3H	\$50.00 ea
3427-5-99	4¼Wx4¼D5H	50.00 ea
3427-7-99	4¼Wx4¼D7H	50.00 ea



b Madera Jar Risers

Includes Glass Jars.

ITEM	DESCRIPTION	LIST PRICE
3406-3	14Wx5½Dx3H	\$133.90 ea
3406-6	14Wx5½Dx6H	144.20 ea



c Westport Jar Display BPA FREE

Includes Glass Jars.

ITEM	DESCRIPTION	LIST PRICE
1549-2-52	12½Wx4¾Dx2H	\$136.40 ea
1549-4-52	12½Wx4¾Dx4H	136.40 ea
1549-6-52	12½Wx4¾Dx6H	136.40 ea

Optional Melamine Jars

ITEM	DESCRIPTION	LIST PRICE
1432-15	4Wx4Dx4H - Jar w/ Lid	\$22.90 ea
1432-15N	4Wx4Dx4H-Notched	22.90 ea



d Union Square Jar Display

Includes Glass Jars.

ITEM	DESCRIPTION	LIST PRICE
3350-13	10Wx7Dx14H	\$123.60 ea



e Flat Iron Jar Display

Includes Glass Jars. Black (13), Chrome (49).

ITEM	DESCRIPTION	LIST PRICE
1805-2-13	6Wx3¼Dx5H- w/ 3x3 Glass Jars	\$78.30 ea
1805-4-13	12Wx4Dx5H- w/ 4x4 Glass Jars	85.50 ea



1805-4-13

visit us online at: www.calmil.com **CAL·MIL** call toll-free 800-321-9069

Condiment & Packet Displays



Mission Condiment Organizer

Holds up to 3.75" Diameter Cups & Lids. For Lids, Stir-Sticks, Creamers, and Packets. Specify Color: Black (13), Platinum (39).

ITEM	DESCRIPTION	LIST PRICE
1715	15Wx14Dx12H	\$110.50 ea



Soho Condiment Organizer

Holds up to 4" Diameter Cups & Lids. Includes Acrylic Insert for Stir Sticks and Packets.

Specify Color: Black (13), Silver (74).

ITEM	DESCRIPTION	LIST PRICE
1594	15Wx11Dx12H	\$110.50 ea



Iron Packet Organizer

Removable Frost Inserts.

ITEM	DESCRIPTION	LIST PRICE
1252	8Wx6Dx4H	\$100.70 ea



Packet and Straw Organizer

Specify Color: Bamboo (60), Midnight Bamboo (96), Reclaimed Wood (99).

ITEM	DESCRIPTION	LIST PRICE
796	9Wx6Dx4H	\$58.20 ea



Iron Coffee Condiment Display

Holds Up to 3.75" Diameter Cups or Lids.

ITEM	DESCRIPTION	LIST PRICE
1453	12Wx10Dx14H	\$95.90 ea



Luxe Three Compartment Condiment Organizer

Stainless Steel (55).

ITEM	DESCRIPTION	LIST PRICE
3014-55	9Wx4Dx2H	\$79.10 ea



Squared Packet Organizer

Black (13), Stainless Steel (55).

ITEM	DESCRIPTION	LIST PRICE
1611-13	9Wx4Dx2H	\$77.30 ea
1611-55	9Wx4Dx2H	91.00 ea



Bamboo and Midnight Bamboo Packet Organizer

ITEM	DESCRIPTION	LIST PRICE
1246	9Wx4Dx2H - Bamboo	\$29.60 ea
1246-96	9Wx4Dx2H - Midnight	29.60 ea



a Iron Condiment Display

Black (13), Platinum (39).

ITEM	DESCRIPTION	LIST PRICE
1081-39	9Wx6Dx8H	\$99.20 ea
1082-13	13½Wx6¼Dx9H	109.00 ea



2019-96



2019-60

b Midnight Bamboo Condiment Station

Each 298 Sold Separately.

ITEM	DESCRIPTION	LIST PRICE
2019-96	15Wx14¼Dx19¾H	\$93.70 ea
298-96	4½Wx4½Dx8H - 3 Shown	39.80 ea

c Bamboo Condiment Station

Each 298 Sold Separately.

ITEM	DESCRIPTION	LIST PRICE
2019-60	15Wx14¼Dx19¾H	\$93.70 ea
298-60	4½Wx4½Dx8H - 3 Shown	39.80 ea



d Condiment Station

Divider is Removable to Create More Capacity. Dimensions: 5½W13¼Dx14¾H. Specify Color.

ITEM	DESCRIPTION	LIST PRICE
2052	Classic Black	\$153.60 ea
2052-60	Bamboo	192.80 ea
2052-99	Reclaimed Wood	172.00 ea

e Classic Condiment/Airpot Display

Drip Trays Included. Airpots Not Included.

ITEM	DESCRIPTION	LIST PRICE
360-4	7½Wx23¼Dx15¼H	\$198.80 ea



f Midnight Bamboo Single Airpot Stand with Packet Drawer

Drip Tray Included. Airpot Not Included.

ITEM	DESCRIPTION	LIST PRICE
1051-1-96	8¾Wx12¾Dx6¼H	\$91.40 ea



Condiment & Packet Displays



Classic Food Pan Organizer

Includes 6 each 1/9th Pans.

ITEM	DESCRIPTION	LIST PRICE
469	15Wx15Dx10H	\$309.20 ea



Classic Condiment Organizer

Has 2 Slots for Standard Napkin Dispenser (Not Included).

ITEM	DESCRIPTION	LIST PRICE
2044	16Wx19¼Dx16¾H	\$372.90 ea



Classic Condiment Organizer

Has Slot for Standard Napkin Dispenser (Not Included).

ITEM	DESCRIPTION	LIST PRICE
2043	9Wx19¼Dx16¾H	\$293.80 ea



Classic Condiment Organizer

Has Slot for Standard Napkin Dispenser (Not Included). Holds Up to 3.75" Diameter Cups or Lids.

ITEM	DESCRIPTION	LIST PRICE
2042	10Wx17¼Dx14¾H	\$293.80 ea



High Capacity Packet Display

ITEM	DESCRIPTION	LIST PRICE
866	18½Wx16½Dx16H	\$697.90 ea

a Classic Condiment Organizer

Holds Up to 3.75" Diameter Cups or Lids.

ITEM	DESCRIPTION	LIST PRICE
2047	14Wx22½Dx20¼H	\$226.00 ea



b Classic Revolving Condiment Display

ITEM	DESCRIPTION	LIST PRICE
1719	14Wx12½Dx21½H	\$319.60 ea



c Classic 3 Tier Condiment Display

ITEM	DESCRIPTION	LIST PRICE
2053	5¼Wx6¾Dx16H	\$73.50 ea
2054	10¼Wx6¾Dx16H	\$99.20 ea

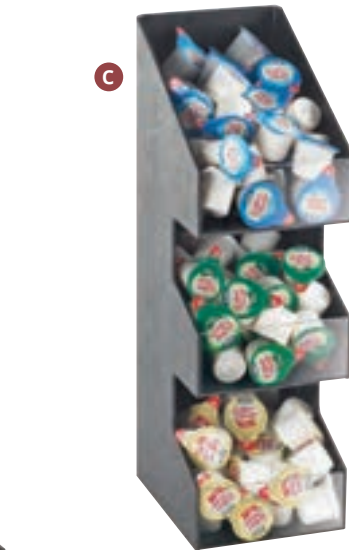

2053



2054

d Classic Condiment Organizer

Dividers are Adjustable.

ITEM	DESCRIPTION	LIST PRICE
2040	12Wx8½Hx4¼H	\$56.40 ea

e Classic Multi-Purpose Food Station BPA FREE

Includes Food Trays.
Each Station Sold Separately.

ITEM	DESCRIPTION	LIST PRICE
495	6Wx27Dx9H	\$287.30 ea
496	13Wx27Dx6H	\$357.60 ea

f Bamboo 3 Tier Condiment Display

ITEM	DESCRIPTION	LIST PRICE
2053-60	5¼Wx6¾Dx16H	\$92.70 ea
2054-60	10¼Wx6¾Dx16H	\$128.80 ea



d



495

496



f



Condiment & Packet Displays



Classic Adjustable Condiment Organizer

Dividers are Adjustable.

ITEM	DESCRIPTION	LIST PRICE
1260	12Wx12Dx5½H	\$64.70 ea

1714-60



Multi-Section Condiment Organizers

ITEM	DESCRIPTION	LIST PRICE
1714-60	12Wx12Dx5½H - Bamboo	\$73.90 ea
1714-96	12Wx12Dx5½H - Midnight Bamboo	73.90 ea
1714-99	12Wx12Dx5½H - Reclaimed Wood	110.00 ea



Luxe Multi-Section Condiment Organizer

Stainless Steel Trim (55).

ITEM	DESCRIPTION	LIST PRICE
3009-55	12¼Wx12¼Dx6½H	\$174.50 ea



Squared Condiment Organizers

Black (13), Stainless Steel (55).

ITEM	DESCRIPTION	LIST PRICE
1616-13	12Wx12Dx5¼H	\$170.50 ea
1616-55	12Wx12Dx5¼H	204.60 ea



Classic Coffee Condiment Display

ITEM	DESCRIPTION	LIST PRICE
1423	5¼Wx6¾Dx21H	\$76.10 ea



Classic Coffee Condiment Display

ITEM	DESCRIPTION	LIST PRICE
1261	6½Wx12Dx20½H	\$73.50 ea



Iron Condiment Display

Includes 3 Removable Bins.

ITEM	DESCRIPTION	LIST PRICE
841	14Wx9Dx7H	\$97.50 ea



a Classic Tri-Bowl Coffee Organizer

ITEM	DESCRIPTION	LIST PRICE
1092	18Wx11Dx9H	\$157.50 ea



b Mission Bowl Display

ITEM	DESCRIPTION	LIST PRICE
1712-8-13	10½Wx15½Dx15½H	\$83.50 ea
1712-10-13	12Wx19Dx17½H	98.40 ea



c 3 Tier Round Bowl Stand

Bowls Sold Separately.

ITEM	DESCRIPTION	LIST PRICE
C1222-8	8Wx16Dx18H - Black Frame	\$71.20 ea
C1222-10	10Wx18Dx18H - Black Frame	78.30 ea
C1223-8	8Wx16Dx18H - Chrome Frame	85.50 ea
C1223-10	10Wx18Dx18H - Chrome Frame	92.70 ea

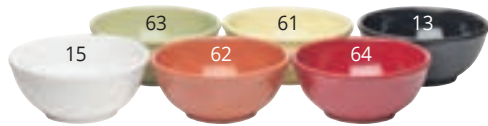

Round Melamine Bowls BPA FREE

Specify Color: Black (13), White (15), Butter Yellow (61), Terra Cotta (62), Sage (63), Cranberry (64).

ITEM	DESCRIPTION	LIST PRICE
418-6	6DIAx3H	\$22.20 ea
418-8	8DIAx3½H	33.00 ea
418-10	10DIAx5H	55.70 ea



d Classic Inline Condiment Organizer

ITEM	DESCRIPTION	LIST PRICE
709-3	7½Wx21Dx16H	\$176.10 ea



e Classic Coffee Condiment Organizer

ITEM	DESCRIPTION	LIST PRICE
1259	8Wx12Dx4H	\$53.40 ea



f Classic Coffee Condiment Organizer

Counter Top or Wall Mount.
White Melamine Jars Not Included.

ITEM	DESCRIPTION	LIST PRICE
786	12Wx8Dx9¼H	\$151.90 ea
C1432BODY	White Melamine Jar	14.80 ea

g Luxe Condiment and Stir Stick Organizer

Stainless Steel Trim (55).

ITEM	DESCRIPTION	LIST PRICE
3013-55	8¾Wx6Dx5H	\$107.50 ea



h Classic Condiment Organizer

ITEM	DESCRIPTION	LIST PRICE
925	8½Wx4Dx12H	\$154.80 ea



786



h

Flatware & Condiment Displays



1235-13-96

3 Tier Bin Displays

ITEM	DESCRIPTION	LIST PRICE
1235-13-43	5¼Wx14Dx18H - Faux Glass	\$189.30 ea
1235-13-60	5¼Wx14Dx18H - Bamboo	158.60 ea
1235-13-96	5¼Wx14Dx18H - Midnight Bamboo	158.60 ea



1235-13-43

Platinum Frame

1235-39-43	5¼Wx14Dx18H - Faux Glass	\$189.30 ea
1235-39-60	5¼Wx14Dx18H - Bamboo	158.60 ea



Glacier Tea Center Display

ITEM	DESCRIPTION	LIST PRICE
1235-TEA	7½Wx14½Dx18H	\$222.10 ea



Solid

Optional Cylinders ^{BPA FREE}

Stainless Steel Color: Perforated (39), (Solid).
Melamine Colors: Black (13), White (15),
Butter Yellow (61), Terra Cotta (62), Sage (63),
Cranberry (64).

ITEM	DESCRIPTION	LIST PRICE
1017-39	4½DIAx5½H	\$14.80 ea
1017-SOLID	4½DIAx5½H	14.80 ea
1017	4½DIAx5½H	18.80 ea



Adjustable Condiment Caddy

Cylinders Sold Separately.
Use for Condiments or Flatware.
Rings are Adjustable.

ITEM	DESCRIPTION	LIST PRICE
3371	10½Wx5¾Dx21H	\$164.80 ea



Union Square Cylinder Stand

Cylinders Sold Separately.

ITEM	DESCRIPTION	LIST PRICE
3375-13	5¾Wx6½Dx19½H	\$110.50 ea



Iron Condiment Display

Includes 3 Removable Bins.

ITEM	DESCRIPTION	LIST PRICE
1709	6½Wx12Dx20½H	\$75.60 ea



a Mission Vertical/Sloped Display

Will Hold Solid, Perforated S/S, or Melamine Cylinders (Sold Separately).
Frame Colors: Black (13), Platinum (39).

ITEM	DESCRIPTION	LIST PRICE
1746-3	7Wx13Dx10¾H	\$110.50 ea
1747-3	7Wx13Dx13H	110.50 ea

b Flat Cylinder Displays

Cylinders Sold Separately.
Colors: Bamboo (60), Midnight Bamboo (96).

ITEM	DESCRIPTION	LIST PRICE
1425-3	16Wx5½Dx6H	\$35.00 ea
1425-6	16Wx11Dx6H	56.10 ea

c Squared Cylinder Stand

Cylinders Sold Separately.
Black (13), Stainless Steel (55).

ITEM	DESCRIPTION	LIST PRICE
1608-13	16Wx5¼Dx6H	\$86.30 ea
1608-55	16Wx5¼Dx6H	99.90 ea

d Iron Single Ring Cylinder Display

Cylinder Included.
Cylinder Style: Perforated (39), (Solid).
Frame Colors: Black (13), Platinum (39).

ITEM	DESCRIPTION	LIST PRICE
1226-13-PERF	6Wx6Dx6H	\$42.80 ea
1226-13-SOLID	6Wx6Dx6H	42.80 ea
1226-39-PERF	6Wx6Dx6H	42.80 ea
1226-39-SOLID	6Wx6Dx6H	42.80 ea

e Iron Revolving Caddy

Cylinders Sold Separately.
ITEM DESCRIPTION LIST PRICE
1035 9Wx9Dx10½H \$86.00 ea

f Revolving Cylinder Stand

Cylinders Sold Separately.
Colors: Black (13), Platinum (39).
ITEM DESCRIPTION LIST PRICE
1227 12Wx12Dx15¾H \$128.10 ea

g Classic Flatware Display

Cylinders Sold Separately.
ITEM DESCRIPTION LIST PRICE
2049 11½Hx15¾Dx15¾H \$175.20 ea



Flatware & Condiment Displays

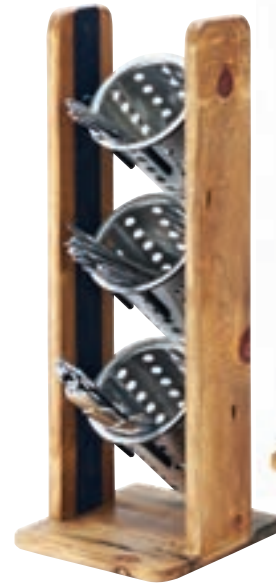

Iron Cylinder Displays

Cylinders Sold Separately.
Specify Frame Color: Black (13), Platinum (39).

ITEM	DESCRIPTION	LIST PRICE
1025-3	4¾Wx8Dx20H	\$103.30 ea
1025-6	9½Wx8Dx20H	161.50 ea

Madera Vertical Cylinder Display *New*

Cylinders Sold Separately. Reclaimed Wood (99).

ITEM	DESCRIPTION	LIST PRICE
3411-99	7¼Wx7¾Dx20½H	\$136.60 ea

Optional Cylinders

Available in Six Colors.
Stainless Steel Styles: Perforated (39), (Solid).
Melamine Colors: Black (13), White (15),
Butter Yellow (61), Terra Cotta (62), Sage
(63), Cranberry (64).



ITEM	DESCRIPTION	LIST PRICE
1017-39	4½DIAx5½H	\$14.80 ea
1017-SOLID	4½DIAx5½H	14.80 ea
1017	4½DIAx5½H	18.80 ea



Luxe Vertical Cylinder Display

Cylinders Sold Separately.
Stainless Steel Trim (55).

ITEM	DESCRIPTION	LIST PRICE
3010-55	6¾Wx7½Dx20¼H	\$159.00 ea



Urban Cylinder Display

Cylinders Sold Separately.
Stainless Steel (55).

ITEM	DESCRIPTION	LIST PRICE
3411-55	6¾Wx7½Dx20¼H	\$154.50 ea



One by One Metal Cylinder Display

Cylinders Sold Separately.
Specify Color: Black (13), Silver (74).

ITEM	DESCRIPTION	LIST PRICE
1134	7½Wx6½Dx17¾H	\$132.40 ea



a Madera Organizer 

Cylinders Sold Separately.
Reclaimed Wood (99).

ITEM	DESCRIPTION	LIST PRICE
3423-3-99	6¼Wx14½Dx15H	\$136.60 ea

b Squared 3 Cylinder Display

Cylinders Sold Separately.
Black (13), Stainless Steel (55).

ITEM	DESCRIPTION	LIST PRICE
1605-13	5Wx8Dx20½H	\$159.00 ea
1605-55	5Wx8Dx20½H	204.60 ea

c Soho Cylinder Display 

Cylinders Sold Separately.
Specify Color: Black (13), Silver (74).

ITEM	DESCRIPTION	LIST PRICE
1583	8¾Wx8½Dx21H	\$113.60 ea

d Eco Modern Cylinder Display 

Cylinders Sold Separately.

ITEM	DESCRIPTION	LIST PRICE
1283	6½Wx8Dx17H	\$136.40 ea

e Faux Stainless Organizer

Cylinders Sold Separately.
Faux Brushed Stainless Steel ABS.

ITEM	DESCRIPTION	LIST PRICE
1232	6Wx12Dx15½H	\$115.70 ea

f Bamboo/Midnight Bamboo Cylinder Display 

Cylinders Sold Separately. Specify Color:
Bamboo (60), Midnight Bamboo (96).

ITEM	DESCRIPTION	LIST PRICE
1016-3	6¼Wx9½Dx22¾H	\$136.60 ea

g Condiment Organizer

3 Solid Cylinders Included.

ITEM	DESCRIPTION	LIST PRICE
1016-3S	5½Wx9¼Dx21H	\$152.60 ea

h Classic Cylinder Display

Cylinders Sold Separately.
Made with Durable ABS.

ITEM	DESCRIPTION	LIST PRICE
1016-3	5½Wx8Dx20H	\$139.90 ea
1016-6	11Wx8Dx20H	192.20 ea



Flatware Displays



1244



1244-96

Bamboo Flatware Displays

ITEM	DESCRIPTION	LIST PRICE
1244	8¼Wx5½DX4¾H - Bamboo	\$58.20 ea
1244-96	8¼Wx5½DX4¾H - Midnight	58.20 ea



Urban Flatware Organizer

Stainless Steel (55).

ITEM	DESCRIPTION	LIST PRICE
3408-55	8¼Wx5¼DX6H	\$80.30 ea



Luxe Flatware Organizer

Stainless Steel Trim (55).

ITEM	DESCRIPTION	LIST PRICE
3015-55	8¼Wx5¾DX6H	\$107.50 ea



Glacier Flatware Display

ITEM	DESCRIPTION	LIST PRICE
H350-13	6Wx6DX6H	\$119.10 ea



Madera Flatware Display New

Plastic Insert Removable for Cleaning. Reclaimed Wood (99).

ITEM	DESCRIPTION	LIST PRICE
3408-99	9Wx6DX5¼H	\$80.30 ea



Classic Flatware/Napkin Display

ITEM	DESCRIPTION	LIST PRICE
910	8Wx8DX5H	\$44.60 ea



1544

Soho Flatware Display

Specify Color: Black (13), Silver (74).

ITEM	DESCRIPTION	LIST PRICE
1544	4Wx4DX4½H	\$45.40 ea



Silver Floor Flatware & Tray Display

Some Assembly Required. Cylinders Not Included. 12" x 20" Trays are Not Included.

ITEM	DESCRIPTION	LIST PRICE
2002-74*	20¾Wx24DX50¼H	\$551.70 ea

*Ships by Truck Only



Chrome Frosted Flatware Display

ITEM	DESCRIPTION	LIST PRICE
587-49	6½Wx6½DX4¾H	\$125.70 ea

a Glacier Napkin Holder 
 ITEM 1242 NAPKIN SIZE 8Wx8D LIST PRICE \$83.30 ea



b Bamboo Napkin Holders 
 ITEM 1234 NAPKIN SIZE 4Wx8H - Bamboo LIST PRICE \$27.00 ea
 1234-96 4Wx8H - Midnight Bamboo 26.30 ea



c Classic Paper Towel Holder
 ITEM 952 NAPKIN SIZE 4Wx8H LIST PRICE \$57.90 ea

d Classic Napkin Holder
 Counter or Wall Mount. 5" Napkin Size.
 Specify Color: Clear (12), Black (13).
 ITEM 635 NAPKIN SIZE 5Wx5H LIST PRICE \$40.10 ea

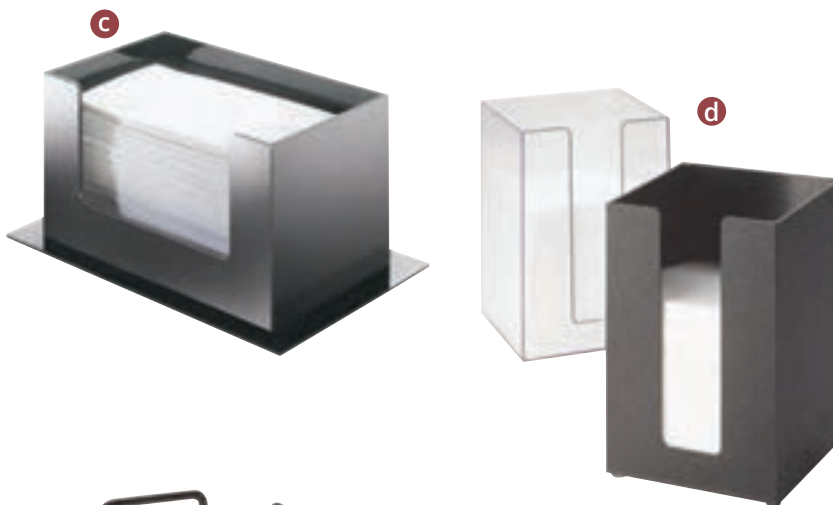

e Iron Napkin Holder 
 ITEM 1243 NAPKIN SIZE 5Wx5H LIST PRICE \$47.50 ea

f Squared Napkin Holder
 Black (13), Stainless Steel (55).
 ITEM 1606-13 NAPKIN SIZE 4Wx8H LIST PRICE \$62.50 ea
 1606-55 4Wx8H 68.10 ea

g Iron Napkin Holder 
 Removable Inner Body.
 ITEM 1253 NAPKIN SIZE 4Wx8H LIST PRICE \$75.60 ea

h Iron Paper Towel Holder 
 ITEM 808-13 NAPKIN SIZE 4Wx8H LIST PRICE \$51.60 ea

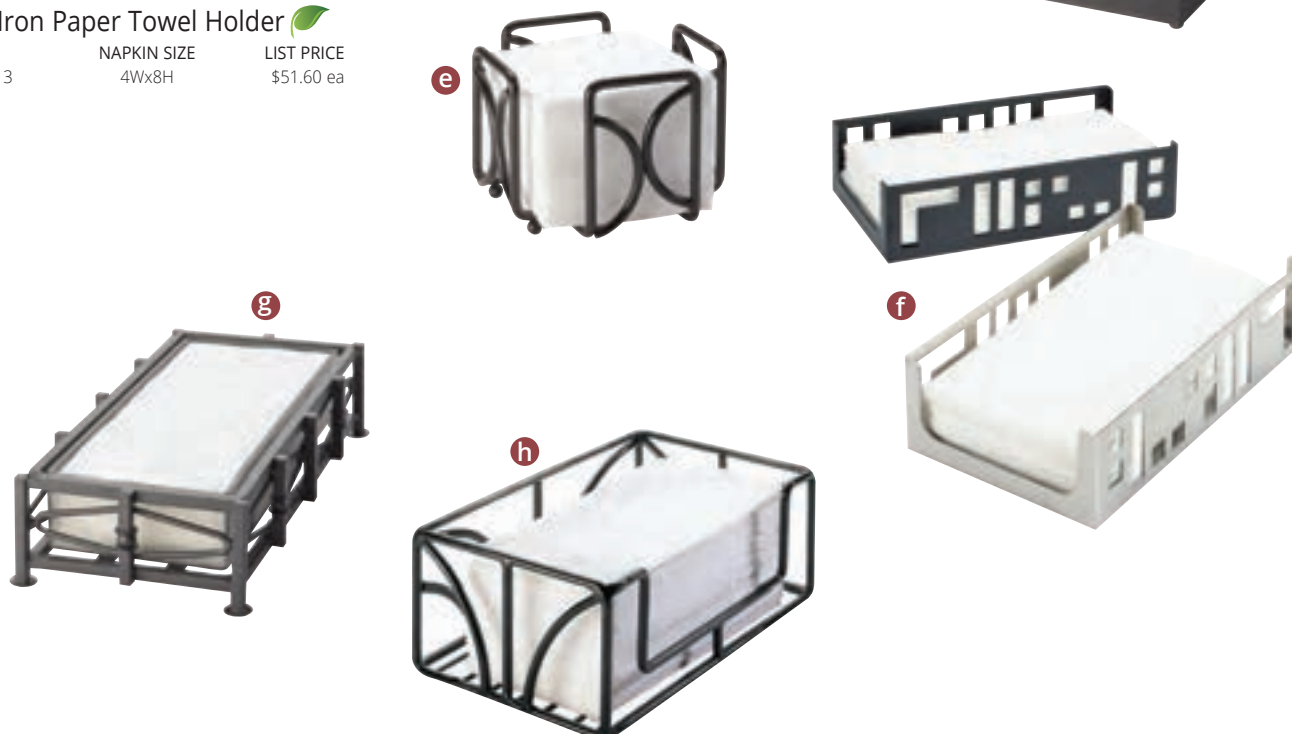

Cup & Lid Organizers



Bamboo Revolving Cup/Lid Organizer

Holds up to 3.75" Diameter Cups & Lids.

ITEM	DESCRIPTION	LIST PRICE
378-60	8Wx8Dx18¼H	\$110.50 ea



Midnight Bamboo Revolving Cup/Lid Organizer

Holds up to 3.75" Diameter Cups & Lids.

ITEM	DESCRIPTION	LIST PRICE
378-96	8Wx8Dx18¼H	\$113.90 ea



Madera Revolving Cup/Lid Organizer New

Holds Up to 3.75" Diameter Cups & Lids.
Reclaimed Wood (99).

ITEM	DESCRIPTION	LIST PRICE
378-99	9Wx9Dx18½H	\$160.00 ea



Bamboo Revolving Cup/Lid Organizer

Holds up to 3.75" Diameter Cups & Lids.

ITEM	DESCRIPTION	LIST PRICE
1468	9Wx9Dx18½H	\$140.40 ea



Iron Revolving Cup/Lid Organizer

Holds up to 3.75" Diameter Cups & Lids.
Specify Frame Color: Black (13), Platinum (39).

ITEM	DESCRIPTION	LIST PRICE
369	8Wx8Dx17½H	\$189.80 ea

a Urban Cup/Lid Organizer
Holds up to 3.75" Diameter Cups & Lids.
Stainless Steel (55).

ITEM	DESCRIPTION	LIST PRICE
3393-55	7¾Wx7¾Dx18H	\$159.00 ea



b Classic Revolving Cup/Lid Organizer
Holds up to 3.75" Diameter Cups & Lids.

ITEM	DESCRIPTION	LIST PRICE
378	8¼Wx8¼Dx18H	\$100.30 ea

c Luxe Revolving Cup/Lid Organizer
Holds up to 3.75" Diameter Cups & Lids.
Stainless Steel (55).

ITEM	DESCRIPTION	LIST PRICE
3001-55	8¼Wx8¼Dx19H	\$159.00 ea

d One by One Revolving Cup/Lid Organizer 
Holds up to 3.75" Diameter Cups & Lids.
Specify Color: Black (13), Silver (74).

ITEM	DESCRIPTION	LIST PRICE
1133	10Wx10Dx15¾H	\$159.00 ea



e Squared Revolving Cup/Lid Dispenser
Holds up to 3.75" Diameter Cups & Lids.
Specify Color: Black (13), Stainless Steel (55).

ITEM	DESCRIPTION	LIST PRICE
1615-13	8¼Wx8¼Dx18¼H	\$159.00 ea
1615-55	8¼Wx8¼Dx18¼H	204.60 ea

f Iron Cup/Lid Organizer 
Holds up to 3.75" Diameter Cups & Lids.

ITEM	DESCRIPTION	LIST PRICE
1229	13Wx4½Dx8¾H	\$73.90 ea
1233	22Wx6Dx9H	98.40 ea

g 3 Tier Cup/Lid Organizer 
Holds up to 3.75" Diameter Cups & Lids.

ITEM	DESCRIPTION	LIST PRICE
1452	5Wx12Dx15H	\$58.50 ea

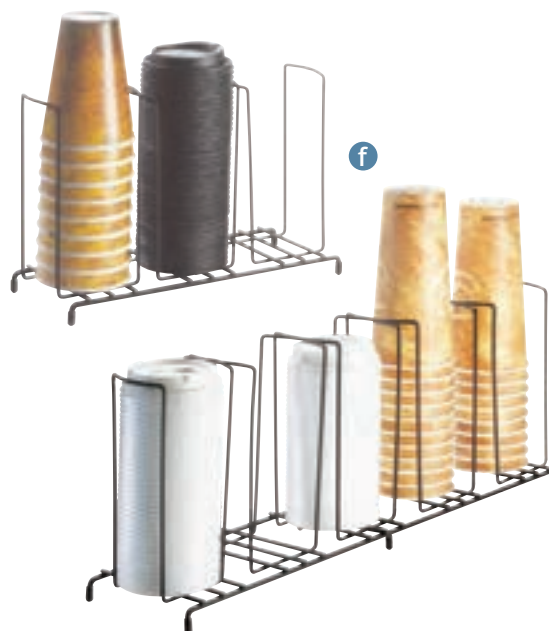

Cup & Lid Organizers



Classic Condiment Organizer

Holds up to 3.75" Diameter Cups & Lids.

ITEM	DESCRIPTION	LIST PRICE
2047	14Wx22½Dx20¼H	\$226.00 ea



Soho Condiment Organizer

Holds up to 3.75" Diameter Cups & Lids. Includes Acrylic Insert for Stir Sticks & Packets. Specify Color: Black (13), Silver (74).

ITEM	DESCRIPTION	LIST PRICE
1594	15¾Wx11¾Dx12H	\$110.50 ea



Iron Coffee Condiment Display

Holds up to 3.75" Diameter Cups & Lids.

ITEM	DESCRIPTION	LIST PRICE
1453	12Wx10½Dx14½H	\$95.90 ea



Classic Cup, Lid and Condiment Organizer

Has Slot for Standard Napkin Dispenser (Not Included). Dividers are Adjustable. Holds up to 3.75" Diameter Cups & Lids.

ITEM	DESCRIPTION	LIST PRICE
2046	9¼Hx19¼Dx16¾H	\$293.80 ea



Classic Cup/Lid Organizer with Coffee Sleeve Dispenser

Coffee Sleeve Dispenser Sold Separately. Holds up to 3.75" Diameter Cups & Lids.

ITEM	DESCRIPTION	LIST PRICE
2045	9¼Wx19¼Dx16¾H	\$307.40 ea
2050	Coffee Sleeve Dispenser	90.40 ea



Iron Bowl and Plate Holders

ITEM	DESCRIPTION	LIST PRICE
1236	9½Wx9½Dx6½H	\$49.10 ea
1237	6½Wx6½Dx8H	36.90 ea



Iron Cup/Lid Holder

ITEM	DESCRIPTION	LIST PRICE
1238	4½Wx4½Dx8¾H	\$36.90 ea
1239	4½Wx4½Dx8¾H	36.90 ea



Iron Cup/Lid Organizer

ITEM	DESCRIPTION	LIST PRICE
3036-13	4¾W11½Dx11¾H	\$73.70 ea

a Condiment Stations

Pieces Sold Separately.
Bamboo (60), Midnight Bamboo (96)

ITEM	DESCRIPTION	LIST PRICE
2019-60	15Wx14½Dx19¾H	\$93.70 ea
298-60	4½Wx4½Dx8H - 3 Shown	39.80 ea
2019-96	15Wx14¾Dx9¾H	93.70 ea
298-96	4½Wx4½Dx8H - 3 Shown	39.80 ea



b Napkin/Lid/Cup Organizers

Bamboo (60), Midnight Bamboo (96),
Reclaimed Wood (99).

ITEM	DESCRIPTION	LIST PRICE
298-60	4½Wx4½Dx8H	\$39.80 ea
298-96	4½Wx4½Dx8H	39.80 ea
298-99	4½Wx4½Dx8H	48.00 ea



2019-60

c Stackable Cup Dispenser and Condiment Display

Each Sold Separately.

ITEM	DESCRIPTION	LIST PRICE
2055	6½Wx22¾Dx6½H	\$285.20 ea
2059	6½Wx22¾Dx6¼D	71.20 ea



d Cup, Lid and Straw Organizers

Holds up to 3.75" Diameter Cups & Lids.

ITEM	DESCRIPTION	LIST PRICE
Classic Black		
2048-3	4½Wx16¼Dx16¼H	\$146.90 ea
2048-4	4½Wx19½Dx19¼H	169.40 ea
2051	4½Wx20Dx19½H	170.00 ea
Bamboo		
2048-3-60	4½Wx16¼Dx16¼H	\$192.80 ea
2048-4-60	4½Wx19½Dx19¼H	225.00 ea
2051-60	4½Wx20Dx19½H	225.00 ea



2051-60

2048-3

2048-3-60

e Ramekin/Lid Organizer

Countertop or Wall Mount.

ITEM	DESCRIPTION	LIST PRICE
278-2	Up to 2½ Diameter	\$49.40 ea
278-3	Up to 3 Diameter	58.70 ea
278-4	Up to 4 Diameter	70.90 ea



f Classic Lid and Cup Organizer

Holds up to 3.75" Diameter Cups & Lids.

ITEM	DESCRIPTION	LIST PRICE
724	15½Wx5Dx12H	\$106.60 ea



g Classic Cup and Lid Organizer with Straw/Stir Stick Holder

Holds up to 3.75" Diameter Cups & Lids.

ITEM	DESCRIPTION	LIST PRICE
2041	14¾Wx8¾Dx10¾H	\$101.70 ea



Cup & Lid Organizers



Classic Napkin/Lid Organizer

Specify Color: Clear (12), Black (13).

ITEM	DESCRIPTION	LIST PRICE
375	13¼Wx5¼Dx8H	\$101.70 ea



Napkin, Lid and Condiment Dispenser

Counter Top or Wall Mount. Hardware Not Included. Holds up to 3.75" Diameter Cups & Lids.

ITEM	DESCRIPTION	LIST PRICE
387-13	17½Wx5Dx8H	\$139.40 ea



Classic Napkin/Lid Organizer

ITEM	DESCRIPTION	LIST PRICE
377-12	26½Wx5Dx6H	\$143.70 ea



Classic Cup/Lid Organizer

Counter Top or Wall Mount. Hardware Not Included.

ITEM	DESCRIPTION	LIST PRICE
1013	13½Wx7¼Dx11½H	\$119.40 ea



Classic Napkin, Lid and Straw Organizers

Counter Top or Wall Mount. Hardware Not Included.

ITEM	DESCRIPTION	LIST PRICE
298	4½Wx4½Dx8H	\$37.90 ea
299	5¼Wx5¼Dx8H	40.10 ea
378	4¼Wx4¼Dx6H	35.60 ea



Classic Napkin, Lid and Straw Organizers

Counter Top or Wall Mount. Hardware Not Included. Specify Color: Clear (12), Black (13).

ITEM	DESCRIPTION	LIST PRICE
298	4½Wx4½Dx8H	\$37.90 ea
299	5¼Wx5¼Dx8H	40.10 ea
378	4¼Wx4¼Dx6H	35.60 ea

a Madera Stir Stick Holder

Reclaimed Wood (99).

ITEM	DESCRIPTION	LIST PRICE
3308-99	5¼Wx5¼Dx5½H	\$60.00 ea



b Classic Straw Stir Stick Organizer

ITEM	DESCRIPTION	LIST PRICE
293	10¼Wx5¼Dx8¼H	\$97.50 ea
294	10¼Wx5¼Dx7¾H	97.50 ea
296	6½Wx5¼Dx8¼H	88.70 ea
1310	12½Wx6Dx7H	48.60 ea
1311	6Wx3½Dx5½H	32.40 ea



293

c Iron Revolving Lid/Ramekin Organizer

ITEM	DESCRIPTION	LIST PRICE
1212-2	Up to 2½ Diameter	\$69.70 ea
1212-3	Up to 3 Diameter	78.30 ea
1212-4	Up to 4 Diameter	86.80 ea



294

d Iron Lid/Ramekin Organizer

ITEM	DESCRIPTION	LIST PRICE
1516-2-13	Up to 2½ Diameter	\$45.40 ea
1516-3-13	Up to 3 Diameter	54.50 ea
1516-4-13	Up to 4 Diameter	64.80 ea



296

e 3 Jar Straw and Stir Stick Holder

Includes 3 Jars and Cut Out Lids.

ITEM	DESCRIPTION	LIST PRICE
3334-13	12¾Wx5Dx3¾H	\$64.30 ea



1311

f Faux Glass Straw and Stir Stick Holder

ITEM	DESCRIPTION	LIST PRICE
1228	3½Wx3½Dx3½H	\$35.40 ea
1228-4	4¾Wx4¾Dx5½H	43.30 ea



1310

g Classic Toothpick Dispenser

ITEM	DESCRIPTION	LIST PRICE
295	3¾Wx3¼Dx5¼H	\$21.30 ea
304	4½Wx3½Dx5¼H	67.50 ea



1228



1228-4

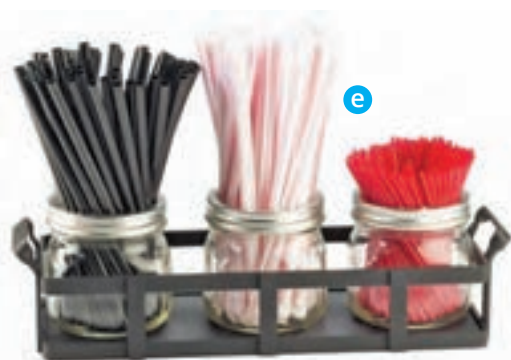

1228



1228-4



295

Signage Displays



Forma Frame Cardholder

ITEM	CARD SIZE	LIST PRICE
828	8½Wx11H	\$62.80 ea
829	4¼Wx5½H	35.00 ea
830	3Wx2½H	19.30 ea



Luxe Signage and Menu Holder

Stainless Steel Trim (55).

ITEM	CARD SIZE	LIST PRICE
3016-811-55	8Wx11H	\$48.00 ea



Iron Signage

ITEM	CARD SIZE	LIST PRICE
1262	3½Wx2H	\$20.10 ea
1264	8½Wx11H	35.20 ea



Midnight Bamboo Signage

ITEM	CARD SIZE	LIST PRICE
1510-32-96	3½Wx2H	\$20.00 ea
1510-46-96	4Wx6H	21.40 ea
1510-811-96	8½Wx11H	34.70 ea



Bamboo Signage

ITEM	CARD SIZE	LIST PRICE
1510-32-60	3½Wx2H	\$20.00 ea
1510-411-60	4Wx11H	29.40 ea
1510-46-60	4Wx6H	21.40 ea
1510-811-60	8½Wx11H	34.70 ea

a Madera Cardholders New

Madera Base, Acrylic Signholder.

ITEM	CARD SIZE	LIST PRICE
3483-23-99	3½Wx2H	\$24.00 ea
3483-46-99	4Wx6H	32.00 ea
3483-811-99	8½Wx11H	48.00 ea



b Brochure Holders

ITEM	CARD SIZE	LIST PRICE
208	4Wx1½Dx8H	\$12.60 ea
209	6Wx1½Dx8H	26.90 ea
210	8½Wx1½Dx10H	47.40 ea

c U-Frame Tabletop Cardholder

ITEM	CARD SIZE	LIST PRICE
1510-32	3½Wx2H	\$20.00 ea
1510-411	4Wx11H	29.40 ea
1510-46	4Wx6H	21.40 ea
1510-811	8½Wx11H	34.70 ea



d Deluxe Cardholder

ITEM	CARD SIZE	LIST PRICE
650-17	4Wx6H	\$24.80 ea
653-17	5½Wx8½H	29.10 ea
695-17	8½Wx11H	40.10 ea

e Classic Acrylic Arched Cardholder

ITEM	CARD SIZE	LIST PRICE
633	8½Wx11H	\$17.90 ea
654	4Wx6H	8.60 ea

f Menu Boards

Specify Color: Black (13), Natural (14).

ITEM	CARD SIZE	LIST PRICE
2034-411	4Wx11H	\$13.30 ea
2034-57	5Wx7H	13.30 ea
2034-811	8½Wx11H	19.80 ea



g Classic Turntable Cardholder

ITEM	CARD SIZE	LIST PRICE
507	4Wx6H	\$19.20 ea
530	4Wx6H	21.40 ea

h Classic Open Book Cardholder

ITEM	CARD SIZE	LIST PRICE
586	4Wx1Dx6H	\$7.20 ea



530



507



Signage Displays



Classic Standard Tabletop Cardholders

ITEM	CARD SIZE	LIST PRICE
P406	4Wx7H	\$5.00 ea
500	4½Wx3½H - Reserved	4.70 ea
521	4¼Wx5½H	4.70 ea
523	4½Wx6½H	5.30 ea
524	5½Wx8½H	7.00 ea
526	8½Wx11H	13.80 ea
532	4Wx6H	4.70 ea
537	4Wx8H	5.50 ea
538	5Wx7H	6.30 ea
591	2¼Wx2¼H	2.50 ea



Classic Upright Tabletop Cardholder

ITEM	CARD SIZE	LIST PRICE
506	4Wx6H	\$5.30 ea
580	5Wx7H	7.00 ea
583	8½Wx11H	16.30 ea



Classic Tabletop Cardholder

ITEM	CARD SIZE	LIST PRICE
541	4Wx4Dx6H	\$12.50 ea
542	4¼Wx4¼Dx7½H	14.90 ea



Classic 3-Wing Tabletop Cardholder

ITEM	CARD SIZE	LIST PRICE
575	4Wx6H - Regular	\$8.50 ea
576	4Wx6H - Footed	9.90 ea

Classic Easel Tabletop Cardholder

ITEM	CARD SIZE	LIST PRICE
509	3½Wx2H	\$4.70 ea
513	8½Wx11H	11.50 ea
515	5Wx7H	6.00 ea
561	5½Wx3½H	4.30 ea



Classic Black Trim Cardholder

ITEM	CARD SIZE	LIST PRICE
534-13	4Wx6H	\$28.10 ea
536-13	8½Wx11H	44.50 ea



Classic T-Type Tabletop Cardholder

ITEM	CARD SIZE	LIST PRICE
512	4Wx6H	\$4.70 ea
570	5Wx7H	6.30 ea



Wall Mount Menu Rack

Mounting Hardware Not Included.

ITEM	DESCRIPTION	LIST PRICE
291	9¼Wx3Dx10H	\$61.70 ea

a One by One Magnetic Sign Displays

Features a Metal Sign with Magnetic Front for Secure Display. Holds 8½x11 Card Size. Specify Color: Black (13), Silver (74).

ITEM	DESCRIPTION	LIST PRICE
1153-15	8½Wx7Dx15H	\$90.40 ea



1153-15

b One by One Tall Magnetic Sign Displays

Features a Metal Sign with Magnetic Front for Secure Display. Holds 8½x11 Card Size. Specify Color: Black (13), Silver (74).

ITEM	DESCRIPTION	LIST PRICE
1153-46	10Wx10Dx46H	\$158.20 ea



1153-46

c Stainless Steel Wet Floor Sign

Double Sided.

ITEM	DESCRIPTION	LIST PRICE
852-55	12Wx17½Dx22H	\$288.40 ea



c

d Wet Floor Signs

Double Sided. Westport (52), Bamboo (60).

ITEM	DESCRIPTION	LIST PRICE
851-WET	12Wx17½Dx20H	\$276.90 ea
852-52	12Wx17½Dx22H - Hinge Stop	221.10 ea
852-60	12Wx17½Dx22H - Hinge Stop	221.10 ea

e Outdoor Wet Floor Sign *New*

Double Sided. Constructed of Composite.

ITEM	DESCRIPTION	LIST PRICE
3504	12Wx17½Dx22H	\$276.90 ea



d

e

Signage Displays



Iron Number Stand

Numbers Sold Separately.

ITEM	DESCRIPTION	LIST PRICE
661-2-13	2Wx2Dx2H	\$5.00 ea
661-9-13	2Wx2Dx9H	7.70 ea
661-12-13	4Wx4Dx12H	10.40 ea



Number Cards

Set of 50.

ITEM	DESCRIPTION	LIST PRICE
671-1	1-50	\$18.30 ea
671-2	51-100	18.30 ea



Coat Check Tags

1½ Diameter Tag.
Set has 2 of Each Number.

ITEM	DESCRIPTION	LIST PRICE
869	1-100	\$117.40 ea
869-1	101-200	117.40 ea
869-2	201-300	117.40 ea



248-13



Card Holders

Holds Business Sized Cards. 1543-60
Good for Chafer Signs or Table Numbers.
Black (13), Bamboo (60).

ITEM	DESCRIPTION	LIST PRICE
248-13	2Wx1Dx2½H	\$4.00 ea
1543-60	2¼Wx¾Dx¾H	5.10 ea



Suggestion Boxes

5" Slot Size. Complete with Locking Feature.

ITEM	DESCRIPTION	LIST PRICE
388	12Wx3½Dx15H	\$131.20 ea
390	7Wx7Dx16H	108.20 ea



Wall Mounted U-Style Holder

Mounting Hardware Not Included.

ITEM	CARD SIZE	LIST PRICE
214	8½Wx¼Dx11H	\$16.60 ea

a Bamboo Beverage Signs

Dimensions: 3"W x 2"H.

ITEM	DESCRIPTION	LIST PRICE
606-1	COFFEE	\$11.30 ea
606-2	DECAF	11.30 ea
606-3	HOT WATER	11.30 ea
606-4	TEA	11.30 ea



b Chalkboard Beverage Signs

Dimensions: 3"W x 2"H.

ITEM	DESCRIPTION	LIST PRICE
3047	Write-On	\$15.50 ea
3047-1	COFFEE	15.50 ea
3047-2	DECAF	15.50 ea
3047-3	HOT WATER	15.50 ea
3047-4	TEA	15.50 ea



c Beverage Tents

Dimensions: 3"W x 1"D x 1½"H.

Specify Color: Silver (010) or Gold (011).

ITEM	DESCRIPTION	LIST PRICE
228-1	COFFEE	\$8.00 ea
228-2	DECAF	8.00 ea
228-3	HOT WATER	8.00 ea
228-5	ICED TEA	8.00 ea
228-7	2% MILK	8.00 ea
228-8	HALF & HALF	8.00 ea



d Urn Chain Signs

Urn Chains: 4"W x 2"H.

ITEM	DESCRIPTION	LIST PRICE
618-1	Coffee	\$18.30 ea
618-2	Decaf	18.30 ea
618-3	Hot Water	18.30 ea



Signage Displays



Break Resistant Number Tents

Numbered on Both Sides. Sets Only.
Dimensions: 3½"W x 3"H.

ITEM	DESCRIPTION	LIST PRICE
White		
234	1-25	\$106.90 ea
234-1	26-50	106.90 ea
Black		
234-13	1-25	106.90 ea
234-1-13	26-50	106.90 ea



Break Resistant Number Tents

Numbered on Both Sides.
Dimensions: 3"W x 3"H.

ITEM	DESCRIPTION	LIST PRICE
White		
227	1-25	\$106.90 ea
227-1	26-50	106.90 ea
227-2	51-75	106.90 ea
227-3	76-100	106.90 ea
Red		
226	1-25	106.90 ea
226-1	26-50	106.90 ea
226-2	51-75	106.90 ea
226-3	76-100	106.90 ea



Engraved Number Tent Sets

Numbered on Both Sides
269 - 3"W x 3"H.
271 - 3½" W x 5" H.

Specify Color: See Color Chart Below.

ITEM	DESCRIPTION	LIST PRICE
269A	1-25	\$162.00 ea
269B	26-50	162.00 ea
269C	51-75	162.00 ea
269D	76-100	162.00 ea
271A	1-25	259.10 ea
271B	26-50	259.10 ea
271C	51-75	259.10 ea
271D	76-100	259.10 ea

Engraved Number Tent

Specify Number and Color: See Chart Below.

ITEM	DESCRIPTION	LIST PRICE
269	3Wx3H	\$7.20 ea
271	3½Wx5H	11.50 ea



Color Chart



Engraved Reserved Tents

Message Imprinted on Both Sides.
Customized Messages Available.
Specify Color: See Color Chart Below.

ITEM	DESCRIPTION	LIST PRICE
273	5Wx1Dx3H	\$14.70 ea



Color Chart



Black Vinyl Tents

Message Imprinted on Both Sides.

ITEM	DESCRIPTION	LIST PRICE
283	9¼Wx1Dx3H	\$11.70 ea
285	5¾Wx1Dx2H	6.80 ea



Black Base Signage

Specify Color: Silver (10), Gold (11).

ITEM	DESCRIPTION	LIST PRICE
956	5Wx1Dx3H	\$18.20 ea



a Chalkboard Beverage Sign

ITEM	DESCRIPTION	LIST PRICE
3047	3Wx2H	\$15.50 ea



b Paddle Write-On Signs

Includes Base.

Specify Color: Black (13), White (15).

ITEM	DESCRIPTION	LIST PRICE
3345	4½Wx2H - w/ Base	\$5.20 ea



c Aztec Write-On Signs

Includes Base.

Specify Color: Black (13), White (15).

ITEM	DESCRIPTION	LIST PRICE
3344	3Wx2H	\$5.20 ea

d Black Stands for Write-On

Write-On Signs Sold Separately.

ITEM	DESCRIPTION	LIST PRICE
3346-5-13	5"H	\$7.40 ea
3346-10-13	10"H	10.00 ea

Signs

3344-13SIGN	Black Aztec (C)	\$3.60 ea
3344-15SIGN	White Aztec (C)	3.60 ea
3345-13SIGN	Black Paddle (B)	3.60 ea
3345-15SIGN	White Paddle (B)	3.60 ea

e Write-On Pens

ITEM	DESCRIPTION	LIST PRICE
240	5 Colored Pens	\$60.20 SET



f Black and White Pens

ITEM	DESCRIPTION	LIST PRICE
3061-13	Black Wet-Erase	\$12.40 ea
3062-15	White Chalkboard Pen	12.40 ea



g Write-On Forma Board

ITEM	DESCRIPTION	LIST PRICE
891	3Wx2Dx2½H	\$19.30 ea

h Classic Write-On Easel

ITEM	DESCRIPTION	LIST PRICE
993-17	8½Wx2Dx12H	\$42.20 ea

i Classic Write-On Easel

ITEM	DESCRIPTION	LIST PRICE
216-13	8½Wx11H	\$19.60 ea
950-13	5Wx7H	10.70 ea



Chalkboard Displays



Chalkboard Signs

"If You Can't Stay, Take Me Away" and "Enjoy Our Specials" are Pre-Printed on Chalkboard.

ITEM	DESCRIPTION	LIST PRICE
3031-811	8½Wx11H - Pre-printed	\$76.00 ea
3031-1224	12Wx24H - Pre-printed Header	120.00 ea
3031-2435	24Wx35H - Pre-Printed "Enjoy Our Specials"	160.00 ea
3348-2435	24Wx35H - Blank	140.00 ea

Chalkboard Pen

3062-15	White Chalkboard Pen	12.40 ea
---------	----------------------	----------

3031-1224
(Pre-printed Header)

3031-811 (Pre-printed)



3031-2435 (Pre-printed Header)



3031-2435 (Pre-printed Header)

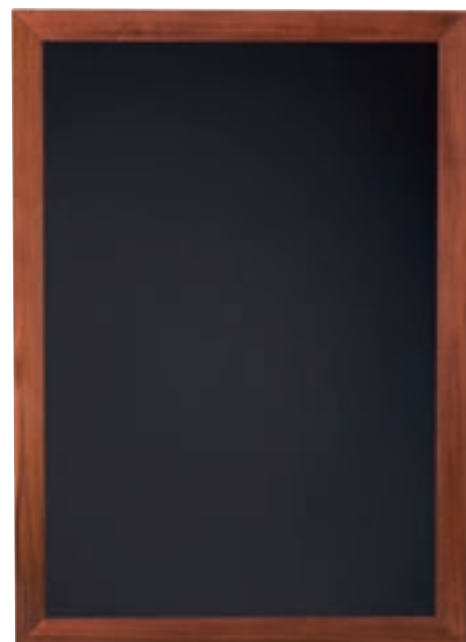

3348-2435 (Blank)

a Madera Chalkboard Signs *New*

Reclaimed Wood (99).

ITEM	CHALKBOARD SIZE	LIST PRICE
3489-23-99	3Wx2H	\$24.00 ea
3489-46-99	4Wx6H	32.00 ea
3489-811-99	8Wx11H	48.00 ea

b Madera Write-On Tasting Crates

Customization is Always Possible!
Glasses Not Included.

ITEM	DESCRIPTION	LIST PRICE
3058	10¼Wx3¼D2¾H	\$28.80 ea

c Chalkboard Write-On Tent

ITEM	DESCRIPTION	LIST PRICE
3047	3Wx2H	\$15.50 ea

d White Chalkboard Pen

ITEM	DESCRIPTION	LIST PRICE
3062-15	White Chalkboard Pen	\$12.40 ea

e Madera Jar Display

Includes 3 Glass Jars, Chalkboard Stick-On's Sold Separately.

ITEM	DESCRIPTION	LIST PRICE
3406-3	14Wx5½D3H	\$133.90 ea
3406-6	14Wx5½D6H	144.20 ea

Optional Chalkboard Stick-On's

3057	3Wx2D	\$15.50 ea
------	-------	------------

f Chalkboard Crate Housings

Includes Clear Polycarbonate Bin for Ice Housings.
Can be Used as Crates or Ice Housings.

ITEM	DESCRIPTION	LIST PRICE
3354-6	7Wx7Dx8H	\$72.10 ea
3354-10	13Wx11Dx7H	123.60 ea
3354-12	13½Wx21½Dx7H	154.50 ea

g Write-On Tasting Boards

2.25" Cut Outs for Glasses. Customization is
Always Possible! Glasses Not Included.

ITEM	DESCRIPTION	LIST PRICE
2063	12Wx6Dx¾H - Reclaimed Wood	\$26.80 ea
2064	12Wx6Dx¾H - Crushed Bamboo	26.80 ea



Room Service & Amenities



Classic Hotel Tray

Black (13), Burl (19).

ITEM	DESCRIPTION	LIST PRICE
958-1-13	22½Wx17Dx1½H - Black	\$53.30 ea
958-1-19	22½Wx17Dx1½H - Burl	97.50 ea
958-2-13	16Wx13Dx1½H - Black	35.60 ea
958-2-19	16Wx13Dx1½H - Burl	71.00 ea



Bamboo Hotel Tray

ITEM	DESCRIPTION	LIST PRICE
958-1-60	22½Wx17Dx1½H	\$66.20 ea



Classic Hotel Tray

ITEM	DESCRIPTION	LIST PRICE
354-1-13	24Wx18Dx2H	\$57.90 ea



Amenity Trays & Organizers

ITEM	DESCRIPTION	LIST PRICE
490-12	7½Wx9½Dx5½H	\$33.60 ea



3 Step Acrylic Amenity Tray

ITEM	DESCRIPTION	LIST PRICE
161-12	7½Wx7½Dx5H	\$24.80 ea



Acrylic Amenity Tray

ITEM	DESCRIPTION	LIST PRICE
809-12	9¾Wx4½Dx2½H	\$14.00 ea



a



b

a Madera Amenity Tray *New*

Reclaimed Wood (99).

ITEM	DESCRIPTION	LIST PRICE
3474-99	12Wx13Dx1½H	\$57.00 ea

b Black Amenity Tray

ITEM	DESCRIPTION	LIST PRICE
353-13	15½Wx12½Dx2H	\$37.90 ea



c

d

c Classic Packet Organizer

ITEM	DESCRIPTION	LIST PRICE
399-13	4Wx3Dx3¼H	\$9.40 ea

d K-Cup Holders *New*

ITEM	DESCRIPTION	LIST PRICE
3485-4-13	4½Wx2Dx5¼H	\$10.00 ea
3485-6-13	6½Wx2Dx5¼H	12.00 ea

e White ABS Room Service Trays *New*

ITEM	DESCRIPTION	LIST PRICE
3475-1-15	15Wx12Dx2¾H	\$40.00 ea
3475-2-15	19½Wx15½Dx2¾H	60.00 ea



e

f Classic Stackable Hotel Tray

ITEM	DESCRIPTION	LIST PRICE
930-1-13	22½Wx17Dx1H	\$53.30 ea
930-2-13	16Wx13Dx1H	35.60 ea
930-3-13	26Wx18Dx1H	61.70 ea



f

Ice Scoops & Holders



Polycarbonate Wall Mount Scoop Holders

Hardware Not Included for Wall Mount.

ITEM	DESCRIPTION	LIST PRICE
790	4½Wx4Dx10H - 6 oz.	\$85.60 ea
356	6Wx5¼Dx11½H - 32 oz.	104.40 ea
793	7½Wx7Dx13H - 64 oz.	133.40 ea



Polycarbonate Freestanding Scoop Holders

Hardware Not Included for Wall Mount.

ITEM	DESCRIPTION	LIST PRICE
789	4½Wx4Dx10H - 6 oz.	\$85.60 ea
355	6Wx5¼Dx11½H - 32 oz.	104.40 ea
792	7½Wx7Dx13H - 64 oz.	133.40 ea



Scoop Guards

Wall Mount Includes Scoop.
Hardware Not Included.

ITEM	DESCRIPTION	LIST PRICE
623	3Wx6Dx10¼H - 6 oz.	\$49.40 ea
624	4¼Wx8Dx11¾H - 32 oz.	70.30 ea
631	7¼Wx5Dx9¾H - 64 oz.	88.40 ea
638	9Wx9Dx8H - 54 oz.	88.40 ea



Ice Scoops

Made from Durable Polycarbonate!

ITEM	DESCRIPTION	LIST PRICE
1029-3S	2¾Wx1¾Dx8¼H - 3 oz. Short Handle	\$8.40 ea
1029-6	3¼Wx2¼Dx10¼H - 6 oz.	7.20 ea
1029-32	4¾Wx3½Dx11H - 32 oz.	13.80 ea
1029-64	6Wx4½Dx14¼H - 64 oz.	15.50 ea



Angled Scoop Guards

Wall Mount Includes Scoop.
Hardware Not Included.

ITEM	DESCRIPTION	LIST PRICE
1031-6	3Wx6Dx10¼H - 6 oz.	\$27.60 ea
1031-32	4¼Wx7½Dx11¼H - 32 oz.	40.10 ea
1031-64	5Wx8½Dx13¾H - 64 oz.	49.40 ea

Yogurt & Ice Cream



1 oz. Candy Scoop

Accommodates All Notched and Holster Topping Dispensers!

ITEM	DESCRIPTION	LIST PRICE
1029-1L	1½Wx1Dx8¼H	\$4.60 ea



287



393

Acrylic Topping Drawers

Notched Drawers to Accommodate Spoons.

ITEM	DESCRIPTION	LIST PRICE
287	13Wx8Dx5H - 8 Drawer	\$237.20 ea
393	13Wx8Dx5H - 4 Drawer	232.30 ea



396

398

Acrylic Cone Holders

Hole Size: Sugar 1.5" Diameter. Waffle or Standard 2" Diameter.

ITEM	DESCRIPTION	LIST PRICE
396	7Wx7Dx4H	\$46.80 ea
398	12Wx4Dx4½H	46.80 ea



1539-12

Revolving Yogurt Cup Dispenser

Holds up to 4½" Diameter Cups.

ITEM	DESCRIPTION	LIST PRICE
1539-12	10Wx10Dx16¾H	\$114.00 ea

Cup & Dome Lid Holder

Holds up to 3.75" Diameter Cups & Lids. Made with Durable ABS.

ITEM	DESCRIPTION	LIST PRICE
724	15½Wx5Dx12H	\$106.60 ea



a Acrylic Cone Cabinet

Hole Size: Waffle or Standard 2" Diameter.

ITEM	DESCRIPTION	LIST PRICE
386	12Wx12Dx15H	\$463.70 ea

b Acrylic Cone Holder w/Guard

Hole Size: Waffle or Standard 2" Diameter.

ITEM	DESCRIPTION	LIST PRICE
297	19Wx6Dx16H	\$88.70 ea

c Acrylic Cone Holder w/Guard

Hole Size: Waffle or Standard 2" Diameter.

ITEM	DESCRIPTION	LIST PRICE
394	20Wx4Dx16H	\$108.60 ea

d Classic Acrylic Protein Powder Bins

ITEM	DESCRIPTION	LIST PRICE
946	13Wx12Dx16½H - 3 Bin	\$485.40 ea
947	4½Wx12Dx16½H - 1 Bin	185.60 ea

e Portion Control Powder Dispensers *New*

Dispense Exact Portions of Protein Powders, Supplements, Drink Mixes, Spices, and More! Includes 5 Interchangeable Portion Cassettes.

ITEM	DESCRIPTION	LIST PRICE
Freestanding		
3522-1-13	6Wx6Dx18¼H - 1.5 Liter	\$265.00 ea
3532-1-13	6Wx6Dx23H - 5 Liter	285.00 ea
Wall Mount		
3531-1-13	6¼Wx7¾Dx9½H - 1.5 Liter	\$190.00 ea
3521-1-13	6Wx6Dx18¼H - 5 Liter	210.00 ea
Replacement Portion Cassette Pack		
3530-PKIT	10,15,20,30, and 35 CC's	\$20.00 ea



visit us online at: www.calmil.com **CAL·MIL** call toll-free 800-321-9069

Yogurt & Ice Cream

All Yogurt and Ice Cream Products are BPA Free.



a Stackable Topping Dispensers

Holster (H), Notch (N).

ITEM	DESCRIPTION	LIST PRICE
927	4Wx11Dx7H	\$88.70 ea
927-H	4Wx11Dx7H	88.70 ea
927-N	4Wx11Dx7H	88.70 ea
1029-1L	1 oz. Spoon	4.60 ea

b Stackable Topping Dispensers

Holster (H), Notch (N).

ITEM	DESCRIPTION	LIST PRICE
492	4½Wx11Dx5½H	\$90.70 ea
492-H	4½Wx11Dx5½H	90.70 ea
492-N	4½Wx11Dx5½H	90.70 ea
1029-1L	1 oz. Spoon	4.60 ea

c Classic Acrylic Topping Dispenser

ITEM	DESCRIPTION	LIST PRICE
1739	4¼Wx12Dx7H	\$93.20 ea
1029-1L	1 oz. Spoon	4.60 ea

d Tall Topping Dispensers

Holster (H), Notch (N).

ITEM	DESCRIPTION	LIST PRICE
373	4Wx11Dx11H	\$117.20 ea
373-N	4Wx11Dx11H	117.20 ea
373-H	4Wx11Dx11H	117.20 ea
1029-1L	1 oz. Spoon	4.60 ea



Notch (N)



Holster (H)



For Additional Sneeze Guards See Pages 131-133.

Portion Control System



a 1.5 Liter Wall Mount Dispenser *New*

Portion Controlled Topping Dispenser Includes 5 Interchangeable Portion Cassettes from 2-7 Tsp. Wall Mounting Hardware Not Included.

ITEM	DESCRIPTION	LIST PRICE
3533-1-13	6¼Wx7¾Dx9½H	\$190.00 ea

Replacement Portion Cassette Pack
3530-PKIT 10,15,20,30, and 35 CC's \$20.00 ea



b 5 Liter Wall Mount Dispenser *New*

Portion Controlled Topping Dispenser Includes 5 Interchangeable Portion Cassettes from 2-7 Tsp. Wall Mounting Hardware Not Included.

ITEM	DESCRIPTION	LIST PRICE
3523-1-13	6Wx6Dx16H	\$210.00 ea

Replacement Portion Cassette Pack
3530-PKIT 10,15,20,30, and 35 CC's \$20.00 ea



c 5 Liter Freestanding Dispenser *New*

Portion Controlled Topping Dispenser Includes 5 Interchangeable Portion Cassettes from 2-7 Tsp.

ITEM	DESCRIPTION	LIST PRICE
3534-1-13	6Wx8Dx23H	\$285.00 ea

Replacement Portion Cassette Pack
3530-PKIT 10,15,20,30, and 35 CC's \$20.00 ea

d 1.5 Liter Freestanding Dispenser *New*

Portion Controlled Topping Dispenser Includes 5 Interchangeable Portion Cassettes from 2-7 Tsp.

ITEM	DESCRIPTION	LIST PRICE
3524-1-13	6¼Wx8Dx16¼H	\$265.00 ea

Replacement Portion Cassette Pack
3530-PKIT 10,15,20,30, and 35 CC's \$20.00 ea

e Triple Cylinder Click Dispensers *New*

Portion Control Mechanism Ensures Equal Portions Without Any Damage and with a Simple Click! Wall Mount Only, Hardware Not Included. 1 Liter Capacity. Specify Color: Red (14), Green (40), Yellow (42), Purple (79), or Orange (80).

ITEM	DESCRIPTION	LIST PRICE
3525-3	15¾Wx7¼Dx12H	\$470.00 ea



Bar & Mixology Displays



1733-3



1733-2



1745



1748-2

Glass Infusion Dispensers ^{BPA FREE}

ITEM	DESCRIPTION	LIST PRICE
1733-2	7½Wx7½Dx12H - 2 Gallon	\$172.00 ea
1733-3	8Wx8Dx19H - 3 Gallon	196.50 ea
1745	10Wx11Dx17¼H - 2 Gallon	172.00 ea
1748-2	8½xWx13¾Dx13¾H - 2 Gallon	170.50 ea
1748-3	8½xWx13¾Dx17½H - 3 Gallon	193.20 ea

Pulp Filter for Dispensers

148-FILTER	2¼Wx2¼	\$50.90 ea
------------	--------	------------



a 3 Tier Chilled Mixology Displays

Complete Set with Cold Pucks.

ITEM	DESCRIPTION	LIST PRICE
16 oz. Jars (14Wx11Dx11¼H)		
1855-4-55	w/ Solid S/S Lids	\$167.10 ea
1855-4-55HL	w/ Hinged S/S Lids	199.20 ea
32 oz. Jars (16Wx12Dx11¼H)		
1855-5-55	w/ Solid S/S Lids	\$221.80 ea
1855-5-55HL	w/ Hinged S/S Lids	253.90 ea

Place Pucks in Freezer for a Minimum of 6 Hours. Keeps Contents Cold for Hours!



b 6 Tier Rotating Mixology Displays

Complete Set with Cold Pucks.

ITEM	DESCRIPTION	LIST PRICE
16 oz. Jars (15Wx15Dx17¼H)		
1858-4-55	w/ Solid S/S Lids	\$319.30 ea
1858-4-55HL	w/ Hinged S/S Lids	350.20 ea
32 oz. Jars (15Wx15Dx17¼H)		
1858-5-55	w/ Solid S/S Lids	\$412.00 ea
1858-5-55HL	w/ Hinged S/S Lids	442.90 ea

c Luxe Jar Displays *New*

Complete Set with Cold Pucks.

Unit Dimensions: 13½Wx5Dx4¾H.

ITEM	DESCRIPTION	LIST PRICE
3492-4-15	w/ Solid S/S Lids	\$144.60 ea
3492-4-15HL	w/ Hinged S/S Lids	176.70 ea



d Stainless Steel Mixology Displays

Complete Set with Cold Pucks.

ITEM	DESCRIPTION	LIST PRICE
16 oz. Jars (13½Wx5Dx4¾H)		
1850-4-55	w/ Solid S/S Lids	\$144.60 ea
1850-4-55HL	w/ Hinged S/S Lids	176.70 ea
32 oz. Jars (13½Wx5Dx6¾H)		
1850-5-55	w/ Solid S/S Lids	\$211.00 ea
1850-5-55HL	w/ Hinged S/S Lids	253.90 ea



e Bamboo Jar Displays

Complete Set with Cold Pucks.

Unit Dimensions: 16Wx6Dx4H.

ITEM	DESCRIPTION	LIST PRICE
1850-4-60	w/ Solid S/S Lids	\$144.60 ea
1850-4-60HL	w/ Hinged S/S Lids	171.40 ea



f Mixology Jars and Components

Jar Sets Include Base and Lid. Cold Pucks Sold Separately. The Base of the Jar is Double Walled for Insulation. The Lid is Lined with Silicone to Ensure a Good Seal.

ITEM	DESCRIPTION	LIST PRICE
Jar Sets		
1851-4	16 oz. Jar w/ Solid S/S Lids	\$19.80 ea
1851-4HL	16 oz. Jar w/ Hinged S/S Lids	30.00 ea
1851-5	32 oz. Jar w/ Solid Lids	28.70 ea

Other Components

1851-4JAR	Replacement Jar for 1851-4	\$11.00 ea
1851-5JAR	Replacement Jar for 1851-5	15.50 ea
1851-4PUCK	Cooling Puck for 16 oz. Jars	5.70 ea
1851-5PUCK	Cooling Puck for 32 oz. Jars	11.30 ea
1851-4LID	Solid S/S Lid for 16 oz. Jar	8.80 ea
1851-5LID	Solid S/S Lid for 32 oz. Jar	11.00 ea
1852-4	S/S Hinged Lid for 16 oz. Jar	12.80 ea
1852-5	S/S Hinged Lid for 32 oz. Jar	14.90 ea



Cooling Puck for Jars (Sold Separately)

Bar & Mixology Displays



a Madera Jar Displays

Includes 3 Glass Jars.
Chalkboard Stick-On's Sold Separately.

ITEM	DESCRIPTION	LIST PRICE
3406-3	14Wx5½Dx3H	\$133.90 ea
3406-6	14Wx5½Dx6H	144.20 ea

Optional Chalkboard Stick-On and Pens

3057	3Wx2D	\$15.50 ea
3062-15	White Chalkboard Pen	12.40 ea



b Madera Single Jar Risers *New*

Includes Glass Jar. Reclaimed Wood (99).

ITEM	DESCRIPTION	LIST PRICE
3427-3-99	4¼Wx4¼Dx3H	\$50.00 ea
3427-5-99	4¼Wx4¼Dx5H	50.00 ea
3427-7-99	4¼Wx4¼Dx7H	50.00 ea



c Urban Stair-Step Jar Displays

Includes 3 Glass Jars. Stainless Steel (55).

ITEM	DESCRIPTION	LIST PRICE
3412-3-55	13Wx13Dx3H	\$154.50 ea
3412-5-55	13Wx13Dx5H	154.50 ea
3412-7-55	13Wx13Dx7H	154.50 ea



d Urban Jar Risers

Includes 1 Glass Jar. Stainless Steel (55).

ITEM	DESCRIPTION	LIST PRICE
3405-3-55	4¼Wx4¼Dx3H	\$67.00 ea
3405-5-55	4¼Wx4¼Dx5H	67.00 ea
3405-7-55	4¼Wx4¼Dx7H	67.00 ea



e 3 Jar Straw and Stir Stick Holder

Includes 3 Jars and Cut Out Lids.

ITEM	DESCRIPTION	LIST PRICE
3334-13	12¾Wx5Dx5¾H	\$64.30 ea
C3334JAR	Replacement Jar	7.80 ea



f Rustic Jar Condiment Display

Includes 3 Jars.

ITEM	DESCRIPTION	LIST PRICE
3335-13	12¾Wx5Dx4H - 17 oz. Jars	\$85.50 ea
3336-13	12¾Wx5Dx6¼H - 32 oz. Jars	91.10 ea

Replacement Jars

C3335JAR	17 oz. Jars	\$13.90 ea
C3336JAR	32 oz. Jars	16.50 ea



Optional Jar and Lids

ITEM	DESCRIPTION	LIST PRICE
Glass Jar		
C4X4GLCN	4x4x4 Glass Jar	\$19.50 ea
Lids		
1807	Solid - Metal Hinge	\$10.50 ea
1807-N	Notched - Metal Hinge	10.50 ea
1811	Solid - Soft Hinge	7.30 ea
1811-N	Notched - Soft Hinge	7.30 ea



Iron 3 Glass Jar Display 
 ITEM DESCRIPTION LIST PRICE
 1805-4-13 12Wx4Dx5H \$85.50 ea



Iron 6 Glass Jar Display 
 Specify Color: Black (13), Platinum (39).
 ITEM DESCRIPTION LIST PRICE
 1809 14Wx9Dx7H \$158.60 ea



Iron High Rise Iced Glass Jar Display 

Includes Glass Jars.
 Specify Color: Black (13), Platinum (39).
 ITEM DESCRIPTION LIST PRICE
 1806-5 13½Wx5½Dx7H \$92.20 ea
 1806-7 13½Wx5½Dx9H 92.20 ea



Aluminum Jar Risers  **BPA FREE**
 Glass Jars Included.
 ITEM DESCRIPTION LIST PRICE
 1560-2 12Wx4¼Dx2H \$159.00 ea
 1560-4 12Wx4¼Dx4H 159.00 ea



Westport Jar Display **BPA FREE**
 Glass Jars Included.
 ITEM DESCRIPTION LIST PRICE
 1549-2-52 12½Wx4¾Dx2H \$136.40 ea
 1549-4-52 12½Wx4¾Dx4H 136.40 ea
 1549-6-52 12½Wx4¾Dx6H 136.40 ea



Iron 3 Step Glass Jar Display 
 Glass Jars Included.
 Black (13), Chrome (49).
 ITEM DESCRIPTION LIST PRICE
 1803-4-13 4Wx12Dx10½H \$102.50 ea
 1803-4-49 4Wx12Dx10½H 102.50 ea



Iron 3 Tier Glass Jar Display 
 Glass Jars Included.
 ITEM DESCRIPTION LIST PRICE
 1804-13 12½Wx11Dx13H \$91.20 ea

Bar & Mixology Displays

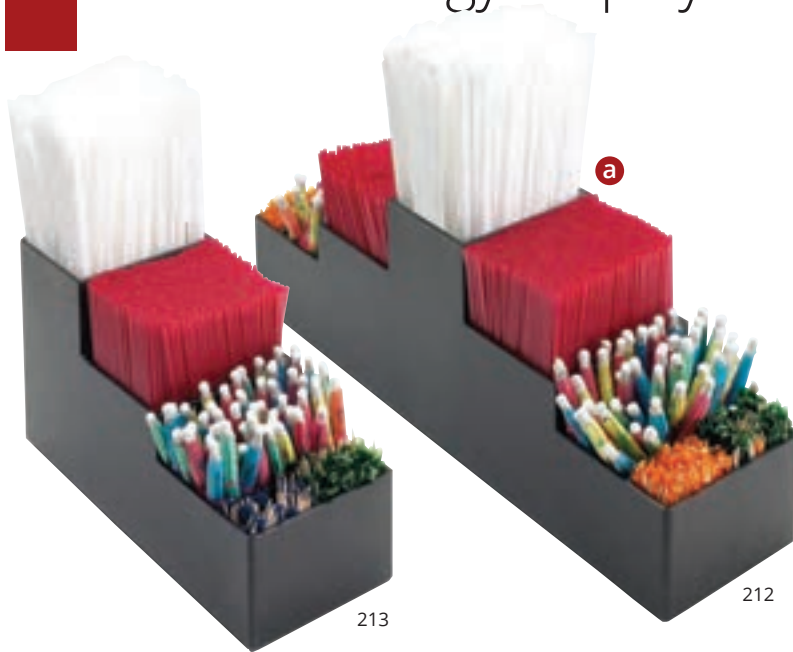

a Classic Bar Organizer

ITEM	DESCRIPTION	LIST PRICE
212	3¾Wx15½Dx5¼H	\$59.40 ea
213	3½Wx9¼Dx5¼H	57.80 ea

b Bar Organizers *New*

Specify Color: Bamboo (60), Reclaimed Wood (99).

ITEM	DESCRIPTION	LIST PRICE
3499	10¾Wx7Dx4¾H	\$85.00 ea

c Madera Stir-Stick Holder *New*

ITEM	DESCRIPTION	LIST PRICE
3308-99	5¼Wx5¼Dx5½H	\$60.00 ea

d Stainless Mixology Organizer

ITEM	DESCRIPTION	LIST PRICE
1853-55	7¼Wx10Dx5¼H	\$154.50 ea

e Iron Napkin Holder *New*

ITEM	NAPKIN SIZE	LIST PRICE
1243	5Wx5H	\$47.50 ea

f Bamboo Bar Napkin Holder *New*

ITEM	DESCRIPTION	LIST PRICE
3309-60	6¼Wx6¼Dx5½H	\$38.50 ea

g Bamboo Straw Holder *New*

ITEM	DESCRIPTION	LIST PRICE
3307-60	5Wx5Dx3½H	\$58.20 ea
3308-60	5Wx5Dx5½H	58.20 ea



3499-60



c



d



e



f



3307

g



3308



Write-On Tasting Boards

2.25" Cut Outs for Glasses.
Customization is Always Possible!
Glasses Not Included.

ITEM	DESCRIPTION	LIST PRICE
2063	12Wx6Dx3¼H - Reclaimed Wood	\$26.80 ea
2064	12Wx6Dx3¼H - Crushed Bamboo	26.80 ea
3062-15	White Chalkboard Pen	12.40 ea

Madera Write-On Tasting Crates

Customization is Always Possible!
Glasses Not Included.

ITEM	DESCRIPTION	LIST PRICE
3058	10¼Wx3¼Dx2¼H	\$28.80 ea
3062-15	White Chalkboard Pen	12.40 ea



Trio Taster Caddy

2.25" Rings for Glasses.
Glasses Not Included.

ITEM	DESCRIPTION	LIST PRICE
3366-13	5¼DIAx11¼H	\$23.20 ea



Madera Taster Caddy *New*

2.25" Cut Outs for Glasses.
Customization is Always Possible!
Glasses Not Included.

ITEM	DESCRIPTION	LIST PRICE
3480-99	13Wx4Dx2½H	\$28.00 ea
3062-15	White Chalkboard Pen	12.40 ea



Faux Slate and Cement Taster Flights *New*

Constructed of Melamine.
Specify Color: Faux Slate (65M), Faux Cement (77).

ITEM	DESCRIPTION	LIST PRICE
3500	11¾Wx5Dx3¼H	\$26.00 ea
3061-13	Black Wet Erase Pen	12.40 ea
3062-15	White Chalkboard Pen	12.40 ea

Bar & Mixology Displays



Classic Bottle Display

Specify Color: Crystal Ice (67) or Graphite (69).

ITEM	DESCRIPTION	LIST PRICE
1491	12Wx13Dx6¾H	\$124.30 ea



Under Lit Bottle Display

Includes LED Light with Multiple Colors and Sequences to Synchronize with Music!

ITEM	DESCRIPTION	LIST PRICE
1269	24Wx14½Dx15½H	\$877.60 ea



Sound-Reduction Blender Housing

ITEM	DESCRIPTION	LIST PRICE
498	12Wx12Dx24½H	\$529.80 ea



Frost Lit Step Bottle Display

Includes LED Light with Multiple Colors and Sequences to Synchronize with Music!

ITEM	DESCRIPTION	LIST PRICE
LQ31	30Wx18Dx18H	\$1,097.00 ea



a Single Wall Mount Dispenser *New*

3.5 Liter Capacity.
Mounting Hardware Not Included.

ITEM	DESCRIPTION	LIST PRICE
3512-1-39	6Wx6Dx12¼H	\$130.00 ea

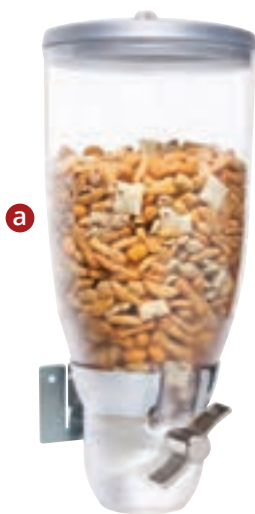

b Double Cylinder Dispenser *New*

5 Liter Capacity Per Cylinder.

ITEM	DESCRIPTION	LIST PRICE
3516-2-13	12¾Wx11Dx25¾H	\$590.00 ea



c Silver Double Cylinder Dispenser *New*

3.5 Liter Capacity Per Cylinder.

ITEM	DESCRIPTION	LIST PRICE
3510-2-39	12¼Wx6Dx17¾H	\$262.00 ea



d Stainless Dry Food Dispenser *New*

3.5 Liter Capacity Per Cylinder.

ITEM	DESCRIPTION	LIST PRICE
3511-2-55	12¼Wx6Dx17¾H	\$440.00 ea



e Stainless Steel Wine Chiller

Keep Cold Pack in Freezer for Minimum of 6 Hours to Keep Wine Chilled.

ITEM	DESCRIPTION	LIST PRICE
3051-55	10¼Wx4½D10H	\$206.00 ea



f Clear Ice Bucket

ITEM	DESCRIPTION	LIST PRICE
694	8Wx8½Dx8H	\$49.00 ea



Custom

We Make Custom Easy

- No Minimums & No Maximums
- Quick Turn Around from Prototype to Production
- Metal, Plastics, Bamboo, Glass, Wood, Stainless
- We Make It Right!



Replacement Parts for Beverage Dispensers

ITEM	BASE	PRICE	ICE CHAMBER	PRICE	BEV CHMBR	PRICE	LID	PRICE	INFUSION	PRICE	SPIGOT	PRICE	DRIP	PRICE
972-1	C972-3B*	197.60	C972-1ICE	76.40	C972-1BEV	371.10	C972-3LID	65.50	C972-1INF	76.40	148	44.60	308-4-13	9.90
972-2	C972-2B	187.30	C972-2ICE	76.40	C972-2BEV	417.60	C972-2LID	57.40	C972-2INF	76.40	148	44.60	308-4-13	9.90
972-3	C972-3B*	197.60	C972-3ICE	76.40	C972-3BEV	574.70	C972-3LID	65.50	C972-3INF	76.40	148	44.60	308-4-13	9.90
972-5	C972-5B*	296.30	C972-5ICE	76.40	C972-5BEV	741.90	C972-5LID	81.90	C972-5INF	76.40	148	44.60	308-4-13	9.90
153-2	C972-2B	187.30	C972-2ICE	76.40	C972-2BEV	417.60	C972-2LID	57.40	C972-2INF	76.40	148	44.60	308-4-13	9.90
153-3	C972-3B*	187.30	C972-3ICE	76.40	C972-3BEV	574.70	C972-3LID	65.50	C972-3INF	76.40	148	44.60	308-4-13	9.90
153-5	C153-5B*	187.30	C972-5ICE	76.40	C972-5BEV	741.90	C972-5LID	81.90	C972-5INF	76.40	148	44.60	308-4-13	9.90
971-5	C972-5B*	296.30	C971-5ICE	76.40	C971-5BEV	834.20	C972-5LID	81.90	N/A	76.40	148	44.60	308-4-13	9.90
1111	C1111BASE	154.90	C972-2ICE	76.40	C1111-BEV	137.40	C1111LID	31.80	C972-2INF	76.40	148-1111	44.60	308-4-13	9.90
1111a	C1111BASE	154.90	C972-2ICE	76.40	C1111A	136.70	C1111LID	31.80	C972-2INF	76.40	148-1111	44.60	308-4-13	9.90
1111-55	C111155BASE	154.90	C972-2ICE	76.40	C1111-BEV	137.40	BR103LID	49.10	C972-2INF	76.40	148-1111	44.60	308-4-13	9.90
932-2	C1111BASE	154.90	C972-2ICE	76.40	C932-2BEV	417.60	C932-2LID	57.40	C972-2INF	76.40	148	44.60	308-4-13	9.90
932-3	C932-3B	197.60	C972-3ICE	76.40	C932-3BEV	574.70	C932-3LID	65.50	C972-3INF	76.40	148	44.60	308-4-13	9.90
1112-1	N/A		C1112-1ICE	76.40	N/A		C938LID	43.70	C1112-1INF	76.40	148-1111	44.60	308-4-13	9.90
1112-3	N/A		C1112-3ICE	76.40	N/A		C938LID	43.70	C1112-3INF	76.40	148-1111	44.60	308-4-13	9.90
1112-1A	N/A		C1112-1ICE	76.40	N/A		C1112-LID	43.70	C1112-1INF	76.40	148	44.60	308-4-13	9.90
1112-3A	N/A		C1112-3ICE	76.40	N/A		C1112-LID	43.70	C1112-3INF	76.40	148	44.60	308-4-13	9.90
1112-5A	N/A		C1112-5ICE	76.40	N/A		C1112-5LID	43.70	C1112-5INF	76.40	148	44.60	308-4-13	9.90

Replacement Parts

ITEM	BASE	PRICE	ICE CHAMBER	PRICE	BEV CHMBR	PRICE	LID	PRICE	INFUSION	PRICE	SPIGOT	PRICE	DRIP	PRICE
1112-1-13	C1112GBASE	158.60	C1112-1ICE	76.40	C1112-1BEV	385.90	C938LID	43.70	C1112-1INF	76.40	148-1111	44.60	308-4-13	9.90
1112-3-13	C1112GBASE	158.60	C1112-3ICE	76.40	C1112-3BEV	395.20	C938LID	43.70	C1112-3INF	76.40	148-1111	44.60	308-4-13	9.90
1112-1A-13C	C1112GBASE	158.60	C1112-1ICE	76.40	C1112-1ABEV	395.20	C1112-LID	43.70	C1112-1INF	76.40	148	44.60	681-4-13	9.90
1112-3A-13C	C1112GBASE	158.60	C1112-3ICE	76.40	C1112-3ABEV	594.20	C1112-LID	43.70	C1112-3INF	76.40	148	44.60	681-4-13	9.90
1132-1	C11321†	154.90	C1112-1ICE	76.40	C1527-1BEV §	327.80	C1527LID	43.70	C1112-1INF	76.40	148	44.60	681-4-13	9.90
1132-3	C11321†	154.90	C1112-3ICE	76.40	C1527-3BEV §	371.10	C1527LID	43.70	C1112-3INF	76.40	148	44.60	681-4-13	9.90
1132-5	C11325†	154.90	C1527-5ICE	76.40	C1527-5BEV	574.70	C1527-5LID	43.70	C1527-5INFICE	76.40	148	44.60	681-4-13	9.90
1282-3A	N/A		C2016ICE	76.40	N/A		1282-3ALID	81.90	C2016ICEINF	76.40	148-1580-49	44.60	N/A	
1494	N/A		N/A		N/A		N/A		N/A		148	44.60	N/A	
1610	C1610BASE	113.60	C1610ICE	76.40	C1610BEV	109.30	C1610LID	43.70	C1610INF	76.40	148	44.60	308-4-13	9.90
1010	N/A		C1010ICE	76.40	C1010BEV	142.00	N/A		C1010INF	76.40	148-1010	44.60	N/A	
152-SS	N/A		C972-3ICE	76.40	C972-3BEV	574.70	C152SSLID	127.30	C972-3INF	76.40	148	44.60	308-4-13	9.90
155	N/A		C1010ICE	76.40	C1010BEV	142.00	N/A		C1010INF	76.40	148-1010	44.60	N/A	
1527-1	C1527-BASE**	154.90	C1112-1ICE	76.40	C1527-1BEV	327.80	C1527LID	43.70	C1112-1INF	76.40	148	44.60	681-4-13	9.90
1527-3	C1527-BASE**	154.90	C1112-3ICE	76.40	C1527-3BEV	371.10	C1527LID	43.70	C1112-3INF	76.40	148	44.60	681-4-13	9.90
1580-2	C1580-BASE†	154.90	C972-2ICE	76.40	C1580-2BEV §	136.10	C1580-LID	65.50	C972-2INF	76.40	148	44.60	308-4-13	9.90
1580-3	C1580-BASE†	154.90	C971-5ICE	76.40	C1580-3BEV §	186.80	C1580-LID	65.50	C971-5INF	76.40	148	44.60	308-4-13	9.90
1602-1	C1602-BASE††	154.90	C1112-1ICE	76.40	C1527-1BEV §	327.80	C1527LID	43.70	C1112-1INF	76.40	148	44.60	681-4-13	9.90
1602-3	C1602-BASE††	154.90	C1112-3ICE	76.40	C1527-3BEV §	371.10	C1527LID	43.70	C1112-3INF	76.40	148	44.60	681-4-13	9.90
1733-2	N/A		N/A		N/A		C938LID	43.70	N/A		148-1111	44.60	N/A	
1733-3	N/A		N/A		N/A		C938LID	43.70	N/A		148-1111	44.60	N/A	
1745	N/A		N/A		N/A		C1111LID	31.80	N/A		148-1111	44.60	N/A	
1990-3	N/A		C1990SSTUBE	104.00	C1990-3BEV	371.10	N/A		C1112-3INF	76.40	148	44.60	308-4-13	9.90
1991-3	N/A		C1991SSTUBE	104.00	C1991-3BEV	371.10	N/A		C1112-3INF	76.40	148	44.60	681-4-13	9.90
2016	N/A		C2016ICE	76.40	C20163BEV	186.80	C2016LID	81.90	C2016INF	76.40	148-1111	44.60	681-4-13	9.90
3002-3	C3002355	154.90	C1112-3ICE	76.40	C1991-3BEV	371.10	N/A		C1112-3INF	76.40	148-1580-49	44.60	681-4-13	9.90
3324-3	C3324BASE	154.90	C2016ICE	76.40	C20163BEV	186.80	C2016LID	81.90	C2016INF	76.40	148-1111	44.60	681-4-13	9.90
JC201	CJC200BASE	154.90	C971-5ICE	76.40	CJC310	186.80	N/A		C971-5INF	76.40	148	44.60	N/A	
JC301	C30113	154.90	C971-5ICE	76.40	CJC310	186.80	CJUICELID	81.90	C971-5INF	76.40	148	44.60	308-4-13	9.90

*Specify Base Color: Black (17), Dark Wood (52), Light Wood (53).

** Specify Base Color: Dark Wood (52), Bamboo (60), Midnight Bamboo (96).

†† Specify Base Color: Black (13), Stainless Steel (55).

§ Specify spigot color: Black or Chrome

Replacement Shelves, Drawers, & Bins

ITEM	Description	PART#	PRICE	ITEM	Description	PART#	PRICE
1203	Top Tray	1203-TOP	117.40	1720-3	Clear	1204DRAWER	30.80
	Bottom Tray	1203-BOTTOM	131.80	1720-4	Clear	1204DRAWER	30.80
204	Clear	1204DRAWER	30.80	1718-60	Clear	C1718DRAWER	58.10
1204-13	Black	1204DRAWER-13	33.40	813-52	Dark Wood	813-52DRAWER	58.10
1204-52	Black	1204DRAWER-13	33.40	3054	Cold Concept Items	Cold Pack	14.40

visit us online at: www.calmil.com **CAL-MIL** call toll-free 800-321-9069

Index

Part #	Pack	Shipping Weight	Page	Price Ea.	Part #	Pack	Shipping Weight	Page	Price Ea.	Part #	Pack	Shipping Weight	Page	Price Ea.
1001	1	66	72	230.50	1051-1-96	1	11	38	91.40	1132-3-74	1	32	67	498.00
1006	1	66	72	230.50	1081-39	1	7	195	99.20	1132-3INF-13	1	32	67	498.00
1009	1	30	78	441.40	1082-13	1	11	195	109.00	1132-3INF-74	1	32	67	498.00
1010	1	25	98	498.20	1092	1	25	198	157.50	1132-5-13	1	51	67	685.60
1010INF	1	30	98	498.20	1102	1	53	81	256.10	1132-5-74	1	51	67	685.60
1011	1	30	175	305.50	1103-23-12	6	3	23	18.20	1132-5INF-13	1	51	67	685.60
1011-S	1	30	175	320.20	1103-23-60	6	3	23	18.20	1132-5INF-74	1	51	67	685.60
1012	1	43	175	381.70	1103-811-12	6	15	23	34.10	1133-13	1	19	68	159.00
1012-S	1	43	175	405.30	1103-811-60	6	15	23	34.10	1133-74	1	19	68	159.00
1013	1	13	80	119.40	1111	1	36	97	441.40	1134-13	1	11	68	132.40
1014	1	30	81	349.60	1111-55	1	26	95	441.40	1134-74	1	11	68	132.40
1016-3	1	12	77	139.90	1111A	1	36	97	452.00	1135-12-13	1	24	69	488.80
1016-3-60	1	12	22	136.60	1111INF	1	36	97	441.40	1135-12-74	1	24	69	488.80
1016-3-96	1	15	37	136.60	1111INF-55	1	30	95	441.40	1140-13	1	18	66	176.50
1016-3S	1	12	77	152.60	1112-1	1	30	97	451.90	1140-74	1	18	66	176.50
1016-6	1	26	77	192.20	1112-1-13	1	30	70	462.70	1143-13	1	51	68	508.40
1017-13	3	5	200	18.80	1112-1A	1	22	97	462.70	1143-74	1	51	68	508.40
1017-15	3	5	200	18.80	1112-1A-13	1	22	47	462.70	1143-S-13	1	51	68	508.40
1017-39	3	2	200	14.80	1112-1AINF	1	26	97	462.70	1143-S-74	1	51	68	508.40
1017-61	3	5	200	18.80	1112-1INF	1	30	97	451.90	1145-13	1	86	68	576.20
1017-62	3	5	200	18.80	1112-3	1	58	97	486.60	1145-74	1	86	68	576.20
1017-63	3	5	200	18.80	1112-3-13	1	43	47	498.20	1145-S-13	1	104	68	576.20
1017-64	3	5	200	18.80	1112-3A	1	32	97	498.20	1145-S-74	1	104	68	576.20
1017-SOLID	3	2	200	14.80	1112-3A-13	1	32	47	498.20	1146-13	1	26	68	291.50
1018	1	68	131	314.00	1112-3AH	1	32	97	498.20	1146-74	1	26	68	291.50
1019	1	20	174	220.40	1112-3AINF	1	32	97	498.20	1148-13	1	16	67	155.80
1025-3-13	1	10	202	103.30	1112-3AINFH	1	32	97	498.20	1148-74	1	16	67	155.80
1025-3-39	1	10	202	103.30	1112-3INF	1	56	97	486.60	1149-13	1	15	67	115.80
1025-6-13	1	13	202	161.50	1112-5A	1	51	97	685.60	1149-74	1	15	67	115.80
1025-6-39	1	13	202	161.50	1112-5AH	1	51	97	685.60	1153-15-13	1	11	67	90.40
1029-1L	12	3	226	4.60	1112-5AINF	1	51	97	685.60	1153-15-74	1	11	67	90.40
1029-32	12	15	225	13.80	1112-5AINFH	1	51	97	685.60	1153-46-13	1	50	67	158.20
1029-3S	12	3	225	8.40	1128-1212-15	3	7	66	39.40	1153-46-74	1	50	67	158.20
1029-6	12	5	225	7.20	1128-1212-60	1	4	66	38.50	1155-13	1	26	68	248.50
1029-64	12	23	225	15.50	1132-1-13	1	19	67	462.70	1155-74	1	26	68	248.50
1031-32	1	5	225	40.10	1132-1-74	1	19	67	462.70	1201	1	26	172	220.40
1031-6	1	2	225	27.60	1132-1INF-13	1	19	67	462.70	1202	1	82	170	1014.10
1031-64	1	7	225	49.40	1132-1INF-74	1	19	67	462.70	1202-S	1	96	170	1014.10
1035	1	9	201	86.00	1132-3-13	1	32	67	498.00	1203-13	1	53	164	524.60

Part #	Pack	Shipping Weight	Page	Price Ea.	Part #	Pack	Shipping Weight	Page	Price Ea.	Part #	Pack	Shipping Weight	Page	Price Ea.
1203-49	1	53	164	524.60	1244-96	1	5	39	58.20	1290TRAY	3	14	161	54.20
1204	1	26	165	163.50	1245-12-43	3	10	58	88.20	1291-2	1	26	161	160.10
1204-12	1	26	165	146.90	1246	1	3	23	29.60	1291-3	1	26	161	214.20
1204-13	1	32	165	205.70	1246-13	1	3	76	30.30	1291TRAY	2	9	161	54.20
1204-52	1	26	41	419.60	1246-96	1	3	38	29.60	1292-2	1	16	161	140.70
1204-99	1	32	3	258.00	1247-11	1	26	70	172.00	1292-3	1	26	161	191.00
1204-P	1	30	165	253.70	1247-3	1	10	70	147.50	1292TRAY	3	7	161	46.50
1204P-12	1	36	165	226.80	1247-7	1	18	70	159.80	129-31	1	20	179	644.40
1212-2	1	7	211	69.70	1250-10-13	1	12	71	352.50	1293-2	1	16	161	131.70
1212-3	1	7	211	78.30	1250-12-13	1	26	71	490.90	1293-3	1	26	161	183.20
1212-4	1	14	211	86.80	1250-6-13	1	5	71	113.20	1293TRAY	3	7	161	43.90
1226-13-PERF	1	4	201	42.80	1252	1	5	71	100.70	1308	1	13	117	31.50
1226-13-SOLID	1	4	201	42.80	1253	1	4	71	75.60	1310	1	7	211	48.60
1226-39-PERF	1	4	201	42.80	125-31	1	7	179	267.80	1311	1	3	211	32.40
1226-39-SOLID	1	4	201	42.80	1254	1	49	45	307.40	1318-60	1	16	26	204.60
1227-13	1	17	201	128.10	1256-13	1	32	135	239.30	1324-12	1	8	159	64.10
1227-39	1	17	201	128.10	1259	1	7	75	53.40	1324-16	1	10	159	93.10
1228	6	5	59	35.40	1260	1	9	75	64.70	1324-24	1	13	159	128.00
1228-4	6	12	59	43.30	1261	1	18	77	73.50	1330-12-13	1	76	5	244.30
1229	1	7	207	73.90	1262	6	2	71	20.10	1332-12-60	1	26	29	79.90
123	1	26	164	220.90	126-31	1	13	179	449.50	1332-12-99	1	26	5	150.00
1232	1	13	203	115.70	1264	3	7	71	35.20	1332-12-INSERT	1	18	5	46.80
1233	1	12	207	98.40	1265	1	11	156	60.20	1333-60	1	26	29	191.80
1234	1	3	23	27.00	1269	1	78	236	877.60	1335-15	3	6	115	28.30
1234-96	1	3	39	26.30	127-31	1	7	179	214.70	1335-15N	3	6	115	28.30
1235-13-43	1	13	59	189.30	1278	1	42	30	187.30	1336-15	3	7	115	28.30
1235-13-60	1	12	21	158.60	1279	1	42	30	374.60	1336-15N	3	7	115	28.30
1235-13-96	1	12	37	158.60	1280-2	1	66	165	532.70	1337-60	1	20	24	452.40
1235-39-43	1	13	59	189.30	1280-3	1	96	165	732.60	1338-60	1	12	26	231.80
1235-39-60	1	13	21	158.60	1281-2	1	83	165	666.10	1339-60	1	26	24	101.60
1235-TEA	1	15	59	222.10	1282-3A	1	47	95	498.20	1339-RISER	6	7	24	33.90
1236	3	10	73	49.10	1282-3AINF	1	47	95	498.20	1344-10-13	1	18	124	198.60
1237	3	7	73	36.90	1283	1	13	31	136.40	1344-7-13	1	11	124	198.60
1238	3	5	73	36.90	1284-60	1	19	26	359.60	1348-12-13	1	11	69	187.40
1239	3	3	73	36.90	1285	1	Inquire	139	373.00	1348-22-13	1	18	69	304.40
124	1	66	172	572.40	1286-12-13	1	14	69	187.40	1360-12-13	1	14	44	210.70
1242	1	6	59	83.30	1286-18-13	1	19	69	210.70	1360-22-13	1	26	44	344.20
1243	6	10	205	47.50	1290-2	1	26	160	167.80	1361-12	1	14	70	184.40
1244	1	5	23	58.20	1290-3	1	26	160	219.40	1361-22	1	26	70	319.50

visit us online at: www.calmil.com **CAL-MIL** call toll-free 800-321-9069

Index

Part #	Pack	Shipping Weight	Page	Price Ea.	Part #	Pack	Shipping Weight	Page	Price Ea.	Part #	Pack	Shipping Weight	Page	Price Ea.
1362	1	21	44	123.00	1414-V-13	1	20	44	234.10	1435-2424-60	3	21	151	154.50
1363-13	1	16	44	224.80	142	4	32	81	26.90	1435-2424-96	3	21	151	154.50
1364-12-13	1	11	44	210.70	1423	1	10	198	76.10	1443-12	1	7	151	58.50
1364-22-13	1	20	44	344.20	1425-3-60	1	11	26	35.00	1443-12-60	3	7	151	66.20
1365-12-13	1	26	45	503.50	1425-3-96	1	11	37	35.00	1443-12-96	3	7	151	66.20
1365-18-13	1	41	45	898.80	1425-3-99	1	11	7	48.00	1443-16	1	14	151	93.60
1367-10-60	2	5	29	43.10	1425-6-60	1	15	26	56.10	1443-16-60	3	11	151	96.40
1367-10-99	2	6	5	58.00	1425-6-96	1	15	37	56.10	1443-16-96	3	11	151	96.40
1367-12-60	2	10	29	55.40	1426-60	1	35	22	220.00	1443-24	1	19	151	140.40
1367-12-99	2	14	5	72.00	1431-16	1	5	151	108.80	1443-24-60	3	19	151	154.50
1368-13	1	51	45	500.10	1431-16-60	3	11	151	108.80	1443-24-96	3	19	151	154.50
1375	4	26	121	86.00	1431-16-96	3	11	151	108.80	1444-16	1	6	151	105.40
1391-12	1	4	128	22.90	1431-24	1	19	151	152.10	1444-16-60	3	10	151	108.80
1391-13M	2	4	128	35.30	1431-24-60	3	19	151	154.50	1444-16-96	3	10	151	108.80
1391-15M	2	5	128	35.30	1431-24-96	3	19	151	154.50	1444-24	1	13	151	152.10
1391-LID	12	4	128	2.80	1432-15	3	6	115	22.90	1444-24-60	3	19	151	154.50
1393-12	1	7	128	39.20	1432-15C	3	6	115	26.20	1444-24-96	3	19	151	154.50
1393-13M	2	10	128	60.70	1432-15N	3	6	30	22.90	1449-60	3	30	153	128.80
1393-15M	2	10	128	60.70	1432-15N-C	3	6	115	26.20	1449-68	3	30	153	128.80
1393-LID	12	9	128	6.60	1433-13	1	13	156	159.00	1449-96	3	30	153	128.80
1395-12	1	2	128	21.60	1433-55	1	13	156	159.00	1449-99	3	30	153	245.90
1395-13M	2	5	128	23.20	1434-13	1	8	156	99.60	1452	1	12	71	58.50
1395-15M	2	5	128	23.20	1434-55	1	8	156	99.60	1453	1	23	71	95.90
1396-12	1	6	128	38.10	1435-1212	1	7	151	44.50	1454	1	20	71	87.90
1396-13M	2	13	128	57.40	1435-1212-60	3	6	151	66.20	1455	1	15	71	64.50
1396-15M	2	13	128	57.40	1435-1212-96	3	6	151	66.20	1456	1	10	133	76.10
1396-LID	12	9	128	7.90	1435-1224-60	3	13	18	108.80	1458-30	1	30	133	202.90
1397-12	1	10	128	46.90	1435-1224-96	3	13	32	108.80	1458-48	1	33	133	228.40
1397-13M	2	15	128	83.80	1435-1232-60	3	19	18	139.30	1458-72	1	49	133	253.60
1397-15M	2	15	128	83.80	1435-1232-96	3	19	32	139.30	1461	1	30	69	234.10
1397-LID	12	10	128	9.00	1435-1248-60	2	22	18	154.50	1463	1	18	58	132.10
1398-12	1	38	128	208.10	1435-1248-96	2	22	32	154.50	1464-13	1	66	153	210.70
1398-55	1	41	128	463.40	1435-1616	1	11	151	58.60	1464-48	1	66	153	210.70
1399-12	1	25	128	116.70	1435-1616-60	3	11	151	108.80	1465-10-13	1	14	150	152.10
1399-55	1	16	128	364.10	1435-1616-96	3	11	151	108.80	1465-15-13	1	11	150	187.40
1409-12-13	1	14	69	187.40	1435-1624	1	13	151	70.30	1465-5-13	1	6	150	112.50
1409-22-13	1	22	69	304.40	1435-1624-60	3	15	151	132.40	1466-10-13	1	18	150	175.60
1412-60	1	Inquire	27	3072.60	1435-1624-96	3	15	151	132.40	1466-15-13	1	30	150	222.40
1414-S-13	1	20	44	210.70	1435-2424	1	19	151	93.60	1466-5-13	1	11	150	128.80

Part #	Pack	Shipping Weight	Page	Price Ea.	Part #	Pack	Shipping Weight	Page	Price Ea.	Part #	Pack	Shipping Weight	Page	Price Ea.
1468	1	22	20	140.40	1516-4-13	1	6	211	64.80	1531-612-14	3	3	181	12.50
1471	1	26	31	199.00	1522-1014-65	6	17	184	50.10	1531-616-13	3	3	181	20.50
1471-SET	1	66	31	483.90	1522-1014-65M	3	9	186	42.00	1531-616-14	3	3	181	19.30
1472	1	26	31	383.60	1522-1014-77	6	9	185	42.00	1535-12-13	3	3	181	21.60
1473	1	51	31	468.20	1522-1020-65	6	43	184	84.00	1535-12-14	3	3	181	20.50
1474	1	20	30	152.10	1522-1020-65M	6	20	186	60.00	1535-16-13	3	3	181	26.20
1476-10	1	7	25	124.10	1522-1020-77	6	20	185	60.00	1535-16-14	3	2	181	25.00
1476-12	1	11	25	128.80	1522-1212-65	6	22	184	55.10	1535-24-13	3	4	181	35.20
1477-10-60	1	5	25	42.10	1522-1212-65M	6	14	186	42.00	1535-24-14	3	4	181	34.10
1477-12-60	1	7	25	46.80	1522-1212-77	6	14	185	42.00	1539-12	1	19	92	114.00
1478	1	18	31	114.10	1522-44-65	6	5	184	16.20	1541-3-13	1	56	160	340.90
1479	1	26	31	177.60	1522-518-65	6	21	184	52.30	1542-13	1	42	160	227.30
1480	1	13	30	101.50	1522-518-65M	6	14	186	32.00	1543-60	6	2	23	5.10
1481-10-60	1	5	25	28.00	1522-518-77	6	20	185	32.00	1544-13	4	5	63	45.40
1481-12-60	3	6	25	32.80	1522-712-65	6	16	184	42.50	1544-74	4	5	63	45.40
1486	1	20	22	149.90	1522-712-65M	6	9	186	29.00	1547-3-74	1	31	132	459.70
1486-96	1	20	39	149.90	1522-712-77	6	9	185	29.00	1547-4-74	1	37	132	552.90
1491-67	1	16	236	124.30	1523-12-65	6	15	184	95.00	1547-6-74	1	48	132	640.00
1491-69	1	20	236	124.30	1523-15-65	3	42	184	130.00	1549-2-52	1	9	193	136.40
1494	1	29	98	756.40	1526-55	4	18	120	128.00	1549-4-52	1	11	193	136.40
1499	1	51	31	721.60	1527-1-52	1	30	42	462.70	1549-6-52	1	12	193	136.40
150-10	6	17	119	46.80	1527-1-60	1	22	16	462.70	155	1	65	98	1034.50
1501-13	1	51	59	594.50	1527-1-96	1	30	37	462.70	1556-52	1	20	43	220.60
150-12	6	25	119	62.30	1527-1INF-52	1	30	42	462.70	1560-2	1	9	192	159.00
150-15	4	24	119	84.00	1527-1INF-60	1	30	16	462.70	1560-4	1	11	192	159.00
1505-3	1	49	173	447.10	1527-1INF-96	1	30	37	462.70	1562-2	1	10	25	136.40
1510-32	12	4	213	20.00	1527-3-52	1	32	42	498.20	1562-4	1	10	25	136.40
1510-32-60	6	4	23	20.00	1527-3-60	1	32	16	498.20	1562-6	1	12	25	136.40
1510-32-96	6	4	39	20.00	1527-3-96	1	32	37	498.20	1563-2	1	26	160	227.30
1510-411	6	12	213	29.40	1527-3-99	1	32	4	498.20	1563-3	1	53	160	340.90
1510-411-60	6	9	23	29.40	1527-3INF-52	1	32	42	498.20	1574-13	1	51	64	508.40
1510-46	6	5	213	21.40	1527-3INF-60	1	32	16	498.20	1574-74	1	51	64	508.40
1510-46-60	6	7	23	21.40	1527-3INF-96	1	32	37	498.20	1574-S-13	1	51	64	508.40
1510-46-96	6	7	39	21.40	1527-3INF-99	1	32	4	498.20	1574-S-74	1	51	64	508.40
1510-811	6	20	213	34.70	1528-12-13	1	17	150	109.20	1575-13	1	86	64	576.20
1510-811-60	6	18	23	34.70	152-SS	1	46	95	1013.60	1575-74	1	86	64	576.20
1510-811-96	6	18	39	34.70	1530-616-13	3	3	181	20.50	1575-S-13	1	86	64	576.20
1516-2-13	1	5	211	45.40	1530-616-14	3	3	181	19.30	1575-S-74	1	86	64	576.20
1516-3-13	1	5	211	54.50	1531-612-13	3	3	181	14.80	1576-13	1	16	65	176.50

visit us online at: www.calmil.com **CAL·MIL** call toll-free 800-321-9069

Index

Part #	Pack	Shipping Weight	Page	Price Ea.	Part #	Pack	Shipping Weight	Page	Price Ea.	Part #	Pack	Shipping Weight	Page	Price Ea.
1576-74	1	16	65	176.50	1605-13	1	10	56	159.00	166-3-99	1	13	2	100.00
1580-2-13	1	22	62	462.70	1605-55	1	10	56	204.60	166-7-60	1	26	17	119.00
1580-2-74	1	22	62	462.70	1606-13	1	4	55	62.50	166-7-96	1	26	36	119.00
1580-2INF-13	1	22	62	462.70	1606-55	1	4	55	68.10	166-7-99	1	31	2	136.00
1580-2INF-74	1	22	62	462.70	1607-5-13	1	4	57	68.10	1702-13	1	35	47	186.50
1580-3-13	1	30	62	498.20	1607-5-55	1	4	57	79.60	1702-39	1	35	47	186.50
1580-3-74	1	30	62	498.20	1607-7-13	1	5	57	96.60	1703	2	28	121	55.50
1580-3INF-13	1	30	62	498.20	1607-7-55	1	5	57	113.60	1704-13	1	32	47	155.10
1580-3INF-74	1	30	62	498.20	1607-9-13	1	8	57	147.70	1707-10-13	3	12	115	77.60
1581-12-33	1	26	62	488.80	1607-9-55	1	8	57	170.50	1707-10-15	3	12	114	77.60
1581-12-43	1	26	62	488.80	1608-13	1	6	56	86.30	1707-10-61	3	12	115	77.60
1582-12-33	1	26	62	488.80	1608-55	1	14	56	99.90	1707-10-62	3	12	115	77.60
1582-12-43	1	26	62	488.80	1610	1	36	100	245.80	1707-10-63	3	12	115	77.60
1583-13	1	10	63	113.60	1611-13	1	4	56	77.30	1707-10-64	3	12	115	77.60
1583-74	1	10	63	113.60	161-12	8	24	222	24.80	1708-1014	1	56	73	519.50
1584-12-13	1	74	64	227.30	1611-55	1	4	56	91.00	1708-1318	1	83	73	586.10
1584-12-74	1	74	64	227.30	1612-12-13	1	10	57	204.60	1709	1	18	200	75.60
1586-13	1	30	65	290.90	1612-12-55	1	10	57	272.70	1710-13	1	63	58	416.20
1586-74	1	30	65	290.90	1612-22-13	1	47	57	284.10	1711-3-60	1	10	24	98.40
1588-33	1	5	63	69.80	1612-22-55	1	47	57	329.60	1711-3-65	1	10	155	98.40
1588-43	1	5	63	69.80	1613-13	1	53	55	500.10	1711-5-60	1	11	24	100.80
1593-12-13	3	10	64	51.20	1613-55	1	53	55	613.70	1711-5-65	1	11	155	100.80
1593-12-74	3	10	64	51.20	1614-13	1	26	55	296.80	1711-7-60	1	11	24	110.50
1594-13	1	26	63	110.50	1614-55	1	26	55	337.50	1711-7-65	1	14	155	110.50
1594-74	1	26	63	110.50	1615-13	1	22	54	159.00	1712-10-13	1	35	46	98.40
1595-33	1	5	63	69.80	1615-55	1	22	54	204.60	1712-8-13	1	23	46	83.50
1595-43	1	5	63	69.80	1616-13	1	9	56	170.50	1714	1	10	23	73.90
1602-1-13	1	30	54	462.70	1616-55	1	9	56	204.60	1714-96	1	10	198	73.90
1602-1-55	1	30	54	462.70	1617-13	1	16	57	227.30	1714-99	1	10	9	110.00
1602-1INF-13	1	30	54	462.70	1617-55	1	16	57	272.70	1715-13	1	23	47	110.50
1602-1INF-55	1	30	54	462.70	1621-13	1	51	55	508.40	1715-39	1	23	47	110.50
1602-3-13	1	32	54	498.20	1621-55	1	51	55	558.30	1717-15	1	5	53	37.00
1602-3-55	1	32	54	498.20	1623-13	1	97	55	576.20	1717-60	1	4	27	37.00
1602-3INF-13	1	32	54	498.20	1623-55	1	97	55	633.50	1717-96	1	4	38	37.00
1602-3INF-55	1	32	54	498.20	166-11-60	1	26	17	131.60	1718-60	1	56	17	604.10
1603-12-13	1	26	55	488.80	166-11-96	1	26	36	131.60	1719	1	48	74	319.60
1603-12-55	1	26	55	570.20	166-11-99	1	31	2	160.00	1720-3	1	26	165	226.40
1604-13	1	11	56	125.00	166-3-60	1	12	17	73.50	1720-4	1	30	165	293.10
1604-55	1	11	56	159.00	166-3-96	1	12	36	73.50	1722	1	16	5	270.30

Part #	Pack	Shipping Weight	Page	Price Ea.	Part #	Pack	Shipping Weight	Page	Price Ea.	Part #	Pack	Shipping Weight	Page	Price Ea.
1723-13	1	23	45	159.80	1850-4-13	1	8	90	144.60	1917-2-15	1	24	157	79.10
1723-39	1	23	45	159.80	1850-4-55	1	8	90	144.60	1929-12-60	1	17	27	121.30
1729-3	1	32	132	465.80	1850-4-55HL	1	8	90	176.70	1929-12-96	1	18	35	121.30
1729-4	1	35	132	553.80	1850-4-55NL	1	8	90	176.70	1929-12-99	1	25	3	136.00
1729-6	1	49	132	654.60	1850-4-60	1	8	17	144.60	1930-60	1	47	26	441.40
1733-2	1	22	230	172.00	1850-4-60HL	1	8	17	171.40	1933-60	1	Inquire	27	573.70
1733-3	1	30	230	196.50	1850-5-13	1	11	90	211.00	1933-96	1	Inquire	35	573.70
1735-1014	1	56	73	519.50	1850-5-55	1	11	90	211.00	1933-99	1	Inquire	3	573.70
1735-1318	1	83	73	586.10	1850-5-55HL	1	11	90	253.90	1934-12-60	1	37	144	108.00
1739	6	42	228	93.20	1850-5-55NL	1	11	90	253.90	1934-12-96	1	37	36	108.00
1744	1	32	77	73.20	1851-4	3	5	231	19.80	1934-4-60	1	18	144	64.00
1745	1	29	230	172.00	1851-4-13	3	6	231	19.80	1934-4-96	1	10	36	64.00
1746-3-13	1	12	46	110.50	1851-4HL	3	7	231	30.00	1934-8-60	1	26	144	81.60
1746-3-39	1	12	46	110.50	1851-4JAR	3	6	231	11.00	1934-8-96	1	26	36	81.60
1747-3-13	1	16	46	110.50	1851-4LID	3	2	231	8.80	1940-96	1	76	35	375.10
1747-3-39	1	16	46	110.50	1851-4LID-13	3	2.5	231	8.80	1943-11-60	1	18	16	132.40
1748-2	1	17	230	170.50	1851-4PUCK	3	2	231	5.70	1943-11-96	1	18	36	132.40
1748-3	1	22	230	193.20	1851-5	3	9	231	28.70	1943-3-96	1	10	36	73.80
1750-13	1	35	46	110.50	1851-5-13	3	10	231	28.70	1943-7-60	1	18	16	119.10
1803-4-13	1	11	190	102.50	1851-5JAR	3	11	231	15.50	1943-7-96	1	18	36	119.10
1803-4-49	1	11	190	102.50	1851-5PUCK	3	2	231	11.30	1944-12-60	1	21	16	132.40
1804-13	1	20	192	91.20	1852-4	3	3	231	12.80	1944-12-96	1	21	36	132.40
1805-2-13	1	5	193	78.30	1852-5	3	4	231	14.90	1944-6-60	1	5	16	39.80
1805-4-13	1	9	193	85.50	1853-55	1	6	234	154.50	1944-6-96	1	5	36	39.80
1806-5-13	1	11	192	92.20	1855-4-13	1	22	90	167.10	1944-9-60	1	14	16	79.50
1806-5-39	1	11	192	92.20	1855-4-55	1	25	90	167.10	1944-9-96	1	14	36	79.50
1806-7-13	1	11	192	92.20	1855-4-55HL	1	25	90	199.20	1949-60	3	30	151	93.60
1806-7-39	1	11	192	92.20	1855-4-55NL	1	25	90	199.20	1949-96	3	30	151	93.60
1807	3	2	190	10.50	1855-5-13	1	25	90	221.80	1950-16-13	4	5	115	18.80
1807-N	3	2	190	10.50	1855-5-55	1	25	90	221.80	1950-16-15	4	5	115	18.80
1809-13	1	20	192	158.60	1855-5-55HL	1	25	90	253.90	1950-16-15C	4	4	115	22.50
1809-39	1	20	192	158.60	1855-5-55NL	1	25	90	253.90	1950-16LID	3	2	130	10.50
1811	3	2	190	7.30	1858-4-55	1	35	231	319.30	1950-16LIDN	3	2	130	10.50
1811-N	3	2	190	7.30	1858-4-55HL	1	35	231	350.20	1950-32-13	4	9	115	25.30
1812-13	1	42	191	258.00	1858-5-55	1	43	231	412.00	1950-32-15	4	9	115	25.30
1812-39	1	42	191	258.00	1858-5-55HL	1	43	231	442.90	1950-32-15C	1	11	115	28.90
1817-13	1	25	21	258.00	1915	1	14	42	152.10	1950-32LID	3	2	130	11.30
1817-39	1	25	21	258.00	1915-96	1	14	35	151.90	1950-32LIDN	3	2	130	11.30
1817-96	1	25	37	258.00	1917-1-15	1	10	157	62.20	1950-64-13	4	13	115	34.20

visit us online at: www.calmil.com **CAL·MIL** call toll-free 800-321-9069

Index

Part #	Pack	Shipping Weight	Page	Price Ea.	Part #	Pack	Shipping Weight	Page	Price Ea.	Part #	Pack	Shipping Weight	Page	Price Ea.
1950-64-15	4	13	115	34.20	2048-3	1	11	75	146.90	227-3	1	2	218	106.90
1950-64-15C	4	16	115	38.00	2048-3-60	1	14	20	192.80	228-1-010	12	2	217	8.00
1950-64LID	3	4	130	13.40	2048-4	1	19	75	169.40	228-1-011	12	2	217	8.00
1950-64LIDN	3	4	130	13.40	2048-4-60	1	24	20	225.00	228-2-010	12	2	217	8.00
1990-3-55	1	32	94	603.40	2049	1	23	75	175.20	228-2-011	12	2	217	8.00
1990-3INF-55	1	32	94	603.40	2050	1	5	76	90.40	228-3-010	12	2	217	8.00
1991-3-55	1	32	94	603.40	2050-60	1	11	20	123.20	228-3-011	12	2	217	8.00
1991-3INF-55	1	32	94	603.40	2050-99	1	7	4	136.00	228-5-010	12	2	217	8.00
2002-74	1	69	204	551.70	2051	1	16	75	170.00	228-5-011	12	2	217	8.00
2016-13	1	22	98	246.80	2051-60	1	16	20	225.00	228-7-010	12	2	217	8.00
2016-74	1	22	98	246.80	2051-99	1	24	7	208.00	228-7-011	12	2	217	8.00
2016INF-13	1	22	98	246.80	2052	1	16	77	153.60	228-8-010	12	2	217	8.00
2016INF-74	1	22	98	246.80	2052-60	1	13	21	192.80	228-8-011	12	2	217	8.00
2019-60	1	23	23	93.70	2052-99	1	20	9	172.00	234	1	2	218	106.90
2019-96	1	23	39	93.70	2053	1	13	77	73.50	234-1	1	2	218	106.90
2019-99	1	28	8	120.00	2053-60	1	13	22	92.70	234-1-13	1	2	218	106.90
2026-36-55	1	32	131	474.50	2053-99	1	16	9	108.00	234-13	1	2	218	106.90
2026-4-55	1	35	131	553.60	2054	1	13	77	99.20	237	1	9	157	125.70
2026-6-55	1	49	131	655.30	2054-60	1	15	22	128.80	238	1	9	157	115.70
2027-36-13	1	32	131	565.00	2054-99	1	16	9	132.00	239	1	9	157	271.00
2027-36-74	1	32	131	565.00	2055	1	13	75	285.20	239-2	1	2	157	40.70
2027-4-13	1	35	131	644.10	2056	1	11	78	65.80	239-4	1	4	157	51.50
2027-4-74	1	35	131	644.10	2059	1	13	75	71.20	239-6	1	4	157	70.50
2027-6-13	1	49	131	734.40	2063	6	6	10	26.80	239-8	1	5	157	113.70
2027-6-74	1	49	131	734.40	2064	6	6	221	26.80	240	1	2	219	60.20
2034-411-13	6	5	213	13.30	208	12	9	213	12.60	241	1	66	172	561.90
2034-411-14	6	5	213	13.30	209	6	7	213	26.90	241-S	1	66	172	572.40
2034-57-13	6	5	213	13.30	210	6	12	213	47.40	242-12-24	1	18	138	343.50
2034-57-14	6	5	213	13.30	212	1	9	234	59.40	248-13	24	2	216	4.00
2034-811-13	6	3	213	19.80	213	1	5	234	57.80	252	1	53	174	367.90
2034-811-14	6	3	213	19.80	214	12	11	216	16.60	253	1	51	168	528.50
2040	1	7	76	56.40	216-13	6	7	219	19.60	253-S	1	51	168	558.20
2041	1	15	75	101.70	226	1	2	218	106.90	254	1	42	172	270.10
2042	1	24	76	293.80	226-1	1	2	218	106.90	255	1	51	172	347.30
2043	1	35	76	293.80	226-2	1	2	218	106.90	255-S	1	51	172	347.30
2044	1	43	76	372.90	226-3	1	2	218	106.90	257	1	51	174	449.50
2045	1	38	76	307.40	227	1	2	218	106.90	258	1	20	173	194.40
2046	1	35	76	293.80	227-1	1	2	218	106.90	260	1	51	172	408.50
2047	1	64	76	226.00	227-2	1	2	218	106.90	261	1	56	172	429.30

Part #	Pack	Shipping Weight	Page	Price Ea.	Part #	Pack	Shipping Weight	Page	Price Ea.	Part #	Pack	Shipping Weight	Page	Price Ea.
263-S	1	51	172	429.30	271C-2	1	3	218	259.10	3001-55	1	22	52	159.00
267	1	2	173	26.90	271D-1	1	3	218	259.10	3002-3-55	1	32	52	498.20
268	1	66	168	675.50	271D-10	1	3	218	259.10	3002-3INF-55	1	32	52	498.20
268-S	1	66	168	704.90	271D-11	1	3	218	259.10	3003-55-12	1	11	50	125.00
269-1	1	2	218	7.20	271D-2	1	3	218	259.10	3003-55-15	1	11	50	133.90
269-10	1	2	218	7.20	272	1	14	164	92.10	3004-55	1	14	49	203.50
269-11	1	2	218	7.20	273-1	12	2	218	14.70	3005-10-55	1	12	52	416.80
269-2	1	2	218	7.20	273-10	12	2	218	14.70	3005-12-55	1	18	52	460.70
269A-1	1	2	218	162.00	273-11	12	2	218	14.70	3008-55	1	20	53	257.10
269A-10	1	2	218	162.00	273-2	12	2	218	14.70	3009-55	1	14	51	174.50
269A-11	1	2	218	162.00	278-2	1	5	209	49.40	3010-55	1	13	50	159.00
269A-2	1	2	218	162.00	278-3	1	5	209	58.70	301-10	6	17	118	65.30
269B-1	1	2	218	162.00	278-4	1	7	209	70.90	301-12	6	26	118	84.30
269B-10	1	2	218	162.00	280	1	18	173	173.80	301-15	4	30	118	115.80
269B-11	1	2	218	162.00	280-T	2	6	173	29.90	3011-55	1	14	48	204.60
269B-2	1	2	218	162.00	283	12	2	218	11.70	301-18	2	35	118	173.80
269C-1	1	2	218	162.00	284-52	1	104	40	1040.60	3012-55	1	26	48	284.10
269C-10	1	2	218	162.00	284-60	1	97	17	1040.60	3013-55	1	8	199	107.50
269C-11	1	2	218	162.00	284-96	1	97	34	1040.60	3014-55	1	5	51	79.10
269C-2	1	2	218	162.00	284-S-52	1	97	40	1040.60	3015-55	1	7	51	107.50
269D-1	1	2	218	162.00	284-S-60	1	97	17	1040.60	3016-811-55	3	8	51	48.00
269D-10	1	2	218	162.00	284-S-96	1	97	34	1040.60	3017-51	1	53	127	500.10
269D-11	1	2	218	162.00	285	12	2	218	6.80	3017-55	1	53	48	500.10
269D-2	1	2	218	162.00	287	1	12	226	237.20	3018-55-12	1	36	49	299.90
271-1	1	3	218	11.50	288	1	Inquire	170	2144.00	3018-55-15	1	36	49	321.40
271-10	1	3	218	11.50	289	1	35	174	327.00	3019-55	1	87	51	1156.50
271-11	1	3	218	11.50	291	2	13	214	61.70	3020-55	1	87	51	576.20
271-2	1	3	218	11.50	293	1	7	211	97.50	302-10	6	19	118	91.70
271A-1	1	3	218	259.10	294	1	7	211	97.50	302-12	6	26	118	107.60
271A-10	1	3	218	259.10	295	1	2	211	21.30	302-15	2	30	118	141.60
271A-11	1	3	218	259.10	296	1	7	211	88.70	3021-55	1	26	53	296.80
271A-2	1	3	218	259.10	297	1	24	227	88.70	3022-55	1	35	49	278.50
271B-1	1	3	218	259.10	298-12	4	9	80	37.90	3023-55	1	16	48	227.30
271B-10	1	3	218	259.10	298-13	4	9	80	37.90	3024-55	1	57	49	455.30
271B-11	1	3	218	259.10	298-60	4	9	21	39.80	3025-55	1	18	50	359.90
271B-2	1	3	218	259.10	298-96	4	9	38	39.80	3026-55	1	13	50	325.70
271C-1	1	3	218	259.10	298-99	4	9	8	48.00	3028-57	1	12	158	206.00
271C-10	1	3	218	259.10	299-12	4	12	80	40.10	3028-57L	1	12	158	206.00
271C-11	1	3	218	259.10	299-13	4	12	80	40.10	3028-60	1	12	25	206.00

visit us online at: www.calmil.com **CAL·MIL** call toll-free 800-321-9069

Index

Part #	Pack	Shipping Weight	Page	Price Ea.	Part #	Pack	Shipping Weight	Page	Price Ea.	Part #	Pack	Shipping Weight	Page	Price Ea.
3028-60L	1	12	25	206.00	3055-88-71	3	6	158	41.20	315-15-12	4	7	118	39.10
3029-57	1	25	158	236.90	3056-333	3	6	158	20.60	315-15-13	4	7	118	39.10
3029-57L	1	25	158	236.90	3056-336	3	6	158	24.70	315-18-12	2	13	118	45.50
3029-60	1	25	25	236.90	3056-338	3	10	158	28.80	316-10-12	6	6	118	27.00
3029-60L	1	25	25	236.90	3056-533	3	9	158	24.70	316-12-12	6	11	118	44.60
3031-1224	1	19	220	120.00	3056-536	3	9	158	28.80	316-12-13	6	11	118	51.60
303-12	6	25	118	107.60	3056-538	3	10	158	33.00	316-15	4	16	118	51.70
3031-2435	1	43	220	160.00	3057	12	3	10	15.50	316-18	2	19	118	64.70
303-15	4	29	118	141.60	3058	6	13	10	28.80	319-12B7	2	25	119	77.70
3031-811	1	7	220	76.00	3059	3	2	100	18.50	321-10	4	14	121	50.90
3033-55	1	54	140	899.40	3060-13	1	31	137	103.00	321-12	4	32	121	64.80
3034-55	1	Inquire	140	1563.70	3061-13	3	3	219	12.40	321-13	4	25	121	72.30
3036-13	1	9	73	73.70	3062-15	3	3	219	12.40	321-18	2	41	121	89.10
3037-55	1	43	180	1081.50	3063	1	9	104	129.20	322-10	4	14	121	55.30
3038-12	1	32	144	206.00	3064	1	9	105	144.60	322-12	4	32	121	79.70
3038-4	1	21	144	164.80	3065	1	9	106	88.40	322-18	2	41	121	99.70
3038-8	1	26	144	185.40	3066	1	7	106	88.40	323-12	4	31	121	81.80
304	1	2	211	67.50	3067	1	17	44	123.00	324-10	6	18	121	55.50
3040-60	3	10	182	61.80	3068	1	26	69	234.10	324-12	4	32	121	79.70
3040-71	3	10	182	49.40	308-4-13	12	2	103	9.90	324-18	2	41	121	100.50
3040-78	3	10	182	82.40	308-4-49	12	2	103	13.40	325-10-12	12	10	120	31.00
3041-21	3	10	182	49.40	308-6-13	12	4	103	11.20	325-10-13	12	9	120	37.10
3041-78	3	10	182	61.80	308-6-49	12	4	103	16.50	325-12-12	4	10	120	61.20
3042-21	3	7	182	49.40	310-4-31	6	5	103	45.50	325-12-13	4	10	120	67.50
3042-78	3	7	182	61.80	310-6-31	6	8	103	59.30	325-12-15	4	10	120	67.50
3043-21	3	6	182	49.40	311-10	6	12	119	35.00	325-13-12	4	10	120	36.50
3043-78	3	6	182	61.80	311-12	6	18	119	44.60	325-13-13	4	10	120	42.20
3044-12-78	3	12	183	123.60	311-15	4	30	119	69.80	325-13-15	4	10	120	42.20
3047	12	3	3	15.50	311-18	2	35	119	80.20	325-18-12	4	17	120	86.30
3047-1	12	3	217	15.50	311-7	24	20	119	24.80	325-18-13	4	17	120	128.40
3047-2	12	3	217	15.50	311-9	12	17	119	30.10	325-9-12	6	13	120	40.10
3047-3	12	3	217	15.50	312-10	6	17	119	37.90	327-12	4	18	120	64.80
3047-4	12	3	217	15.50	312-12	6	25	119	46.80	327-13	4	19	120	68.20
3050-32	4	11	110	36.70	312-15	4	30	119	73.20	327-18	2	26	120	85.90
3051-55	1	9	237	206.00	312-18	2	35	119	93.10	327-9	4	26	120	59.00
3052-78	3	9	183	61.80	315-10-12	6	5	118	25.50	328-12	4	26	120	86.70
3053-78	3	9	183	61.80	315-10-13	6	5	118	25.50	328-13	4	19	120	91.20
3055-1212-71	3	11	158	82.40	315-12-12	6	8	118	31.00	328-18	4	41	120	100.50
3055-1216-71	1	5	158	113.30	315-12-13	6	6	118	31.00	329-12	4	26	120	86.00

Part #	Pack	Shipping Weight	Page	Price Ea.	Part #	Pack	Shipping Weight	Page	Price Ea.	Part #	Pack	Shipping Weight	Page	Price Ea.
329-13	4	19	120	91.20	3320-9-55	1	43	111	321.40	3343-8-15	3	7	116	33.00
329-18	2	26	120	101.70	3321-13	1	31	69	455.30	3344-13	6	2	219	5.20
3300-28	4	8	129	23.70	332-12	4	25	121	77.70	3344-13SIGN	12	2	219	3.60
3300-28CLIP	12	2	129	1.60	3322-5-55	1	32	111	278.50	3344-15	6	2	219	5.20
3300-28JP	12	2	129	2.10	3322-9-55	1	43	111	321.40	3344-15SIGN	12	2	219	3.60
3300-28LIDL	12	2	129	2.10	3324-3-55	1	28	94	246.80	3345-13	6	2	219	5.20
3300-28LIDSM	12	2	129	2.10	3324-3INF-55	1	28	94	246.80	3345-13SIGN	12	2	219	3.60
3300-28NODRIP	12	5	129	2.50	3325-55	1	18	126	299.90	3345-15	6	2	219	5.20
3300-28SL	12	2	129	2.10	3326-10-55	1	9	130	139.30	3345-15SIGN	12	2	219	3.60
3300-CLIPSET	1	2	129	15.00	3326-7-55	1	5	130	96.40	3346-10-13	6	10	219	10.00
3300-RACK	1	11	129	68.00	3328-12-55	1	14	53	230.40	3346-5-13	6	2	219	7.40
3300-SET	1	18	129	201.90	3329-12-55	1	35	53	230.40	3347-3-60	1	43	27	329.60
3301-3-60	1	32	16	498.20	3330-13	1	56	156	235.70	3348-2435	1	25	220	140.00
3301-3-96	1	28	37	498.20	3330-39	1	56	156	235.70	3350-13	1	19	193	123.60
3301-3INF-60	1	32	16	498.20	333-10	4	20	120	60.50	335-10-12	6	7	120	32.50
3301-3INF-96	1	38	37	498.20	3331-60	1	9	18	171.40	335-10-13	6	7	120	39.00
3302-3-13	1	36	67	597.60	3331-96	1	22	32	171.40	335-12-12	4	10	120	49.50
3302-3-74	1	36	67	597.60	3332-10-60	1	16	18	139.30	3354-10	1	12	138	123.60
3302-3INF-13	1	36	67	597.60	3332-10-96	1	18	32	139.30	3354-12	1	23	138	154.50
3302-3INF-74	1	36	67	597.60	3332-4-60	1	9	18	96.40	3354-6	1	7	138	72.10
3303-60	1	Inquire	28	642.70	3332-4-96	1	11	32	96.40	3358-13	1	12	28	133.90
3303-96	1	Inquire	66	642.70	3332-7-60	1	14	18	107.10	3359-12-13	1	38	137	484.10
330-4-31	6	6	103	42.10	3332-7-96	1	14	32	107.10	3360-10	1	13	4	123.60
330-4-52	6	4	42	39.90	3334-13	1	11	211	64.30	3360-12	1	26	4	154.50
330-4-60	6	4	17	39.90	3335-13	1	11	232	85.50	336-12	4	14	120	60.50
3304-60	1	Inquire	28	642.70	3336-13	1	15	232	91.10	3361-55	1	51	107	437.80
3304-96	1	Inquire	66	642.70	3337-1218-13	1	3	180	68.60	3364	1	42	92	736.50
330-4-99	1	4	4	39.90	3337-1218-14	1	3	180	68.60	3365-12-13	1	10	65	196.70
330-6-31	6	9	103	57.90	3337-1520-13	1	7	180	101.80	3365-12-74	1	10	65	196.70
330-6-52	6	7	42	50.00	3337-1520-14	1	7	180	101.80	3365-22-13	1	26	65	309.00
330-6-60	12	14	17	50.00	3337-1824-13	1	11	180	133.90	3365-22-74	1	26	65	309.00
330-6-99	6	7	4	50.00	3337-1824-14	1	3	180	133.90	3366-13	3	5	235	23.20
3307-60	1	4	23	58.20	3337-612-13	1	2	180	23.10	3367-13	1	7	104	164.80
3308-60	1	4	23	58.20	3337-612-14	1	4	180	23.10	3367-15	1	7	104	164.80
3308-99	1	4	9	60.00	3338-13	1	43	192	428.50	3367-55	1	7	104	164.80
3309-60	1	5	23	38.50	334-12	4	25	120	82.10	3367-60	1	7	104	123.60
3315	1	23	128	131.60	3342-11-15	3	14	115	55.70	3367-99	1	9	104	123.60
3316	1	13	128	98.80	3342-8-15	3	7	115	33.00	3369-13	1	17	81	164.80
3320-5-55	1	32	111	278.50	3343-10-15	3	12	116	55.70	3370-3-13	1	26	98	498.20

visit us online at: www.calmil.com **CAL-MIL** call toll-free 800-321-9069

Index

Part #	Pack	Shipping Weight	Page	Price Ea.	Part #	Pack	Shipping Weight	Page	Price Ea.	Part #	Pack	Shipping Weight	Page	Price Ea.
3370-3INF-13	1	26	98	498.20	3410-55	1	20	14	164.80	3440-99	1	10	6	220.00
3371	1	18	22	164.80	3411-55	1	10	14	154.50	3441-55	12	6	189	14.00
3372	1	11	75	71.20	3411-99	1	20	7	136.60	3441-65M	12	5	189	10.00
3374-12-60	1	30	29	185.40	3412-3-55	1	9	15	154.50	3442-4	6	6	189	13.00
3374-4-60	1	26	29	164.80	3412-5-55	1	11	15	154.50	3442-5	6	7	189	16.00
3374-8-60	1	30	29	175.10	3412-7-55	1	12	15	154.50	3443	6	9	189	14.00
3375-13	1	11	200	110.50	3413-55	1	66	14	536.60	3444-71	1	48	152	280.00
3390-55	1	20	13	227.30	3414-15	3	8	170	24.70	3446-7	3	6	130	44.00
339-12	4	32	121	102.40	3415-15	3	14	170	41.20	3446-9	3	10	130	60.00
3391-55	1	26	13	283.30	3416	1	41	3	401.70	3447-71	1	48	152	280.00
3393-55	1	22	15	159.00	3417-3	1	9	154	82.40	3448-99	1	41	6	300.00
3394-3-55	1	32	12	498.20	3417-5	1	14	154	84.50	3451-55	1	55	124	350.00
3394-3INF-55	1	32	12	498.20	3417-7	1	14	154	86.50	3451-55FLAT	1	14	124	48.00
3395-10-55	1	12	15	416.80	3418-3	1	10	154	119.50	3451-55GRIDDLE1	14	124	60.00	
3395-12-55	1	18	15	460.70	3418-5	1	31	154	121.50	3454-1014-99	1	19	5	120.00
3396-55	1	53	13	500.10	3418-7	1	31	154	123.60	3454-1220-99	1	26	5	120.00
3397-2-13	1	66	165	566.50	3419-13	1	Inquire	170	1854.00	3455	1	48	47	350.00
3397-2-55	1	66	165	566.50	3421-2	1	30	95	441.40	3456-13	1	24	113	235.70
3397-2-60	1	56	165	566.50	3421-2INF	1	30	95	441.40	3457-13	1	41	124	90.00
3397-3-13	1	96	165	824.00	3422-2	1	42	4	441.40	3458-13	1	36	124	120.00
3397-3-55	1	96	165	824.00	3422-2INF	1	42	4	441.40	3459-1310-65M	3	7	186	34.00
3397-3-60	1	96	165	824.00	3423-3-99	1	16	7	136.60	3459-137-65M	3	7	186	25.00
3398-55	1	6	15	80.30	3427-3-99	1	4	11	50.00	3459-1515-65M	3	9	186	60.00
3398-99	1	5	9	80.30	3427-5-99	1	5	11	50.00	3459-2113-65M	3	10	186	65.00
3399	1	3	110	56.70	3427-7-99	1	13	11	50.00	3459-217-65M	3	10	186	40.00
3401-55	1	98	14	1081.50	3428-99	1	36	3	300.00	3460-1-13	1	30	101	345.00
3402	1	11	104	56.70	3429-99	1	51	6	468.20	3460-1BEV	1	21	4	220.00
3403-12-13	1	14	65	201.90	3432-99	1	104	3	700.00	3461-99	1	Inquire	11	1200.00
3403-12-74	1	21	65	201.90	3432-S-99	1	104	3	700.00	3462-15	6	13	116	9.00
3404-13	1	25	112	257.50	3434-99	1	66	11	800.00	3463-15	6	7	116	25.00
3405-3-55	1	5	15	67.00	3435-99	1	16	6	236.00	3464-15	6	12	116	36.00
3405-5-55	1	7	15	67.00	3436-3	1	32	95	498.20	3465-15	3	13	116	50.00
3405-7-55	1	8	15	67.00	3436-3INF	1	32	95	498.20	3466-15	3	2	116	36.00
3406-3	1	11	10	133.90	3437-3-12	1	67	60	486.60	3467-4-15	6	2	116	6.00
3406-6	1	20	10	144.20	3437-3-43	1	67	60	486.60	3467-5-15	6	4	116	12.00
3407-55	1	14	13	204.60	3437-3INF-12	1	67	60	486.60	3468	6	12	189	21.00
3408-55	1	6	15	80.30	3437-3INF-43	1	67	60	486.60	3469-156-15	3	7	109	32.00
3408-99	1	7	4	80.30	3438-12	1	26	139	488.80	3469-2010-15	3	16	109	78.00
3409-55	1	11	15	144.20	3439-99	1	18	6	300.00	3469-206-15	3	10	109	50.00

Part #	Pack	Shipping Weight	Page	Price Ea.	Part #	Pack	Shipping Weight	Page	Price Ea.	Part #	Pack	Shipping Weight	Page	Price Ea.
3470-15	6	12	116	33.00	3497-3-55	1	55	101	320.00	3516-5-98FF	1	55	82	1150.00
3473-99	1	53	2	220.00	3497-3BEV	1	41	101	200.00	3517-3-39	1	38	82	510.00
3474-99	2	9	5	57.00	3498-10-65M	3	14	115	42.90	3518-3-39	1	36	88	440.00
3475-1-15	2	17	223	40.00	3498-5-65M	3	5	115	15.00	3518-3-39FF	1	30	82	440.00
3475-2-15	2	17	223	60.00	3498-8-65M	3	9	115	32.10	3518-5-39	1	56	88	780.00
3476-2	24	17	189	12.00	3499-60	1	9	234	85.00	3518-5-39FF	1	33	88	780.00
3476-3	24	37	189	16.00	3499-99	1	9	9	85.00	3519-2-39	1	57	89	900.00
3478-3-39	1	40	132	230.00	3500-65M	6	9	188	26.00	3520-5-39	1	37	89	1160.00
3479-55	12	9	116	16.00	3500-77	6	9	188	26.00	3521-1-13	1	18	86	210.00
3480-99	6	12	10	28.00	3501-65M	6	5	188	24.00	3522-1-13	1	10	86	265.00
3481-99	1	9	5	80.00	3501-77	6	5	188	24.00	3523-1-13	1	12	87	210.00
3483-23-99	6	3	11	24.00	3502-12-65M	6	6	186	42.00	3524-1-13	1	12	87	265.00
3483-46-99	6	9	11	32.00	3502-12-77	6	6	185	42.00	3525-3-14	1	20	8	470.00
3483-811-99	6	19	11	48.00	3502-15-65M	3	16	186	60.00	3525-3-40	1	20	229	470.00
3484-13	12	2	115	2.50	3502-15-77	3	16	185	60.00	3525-3-42	1	20	229	470.00
3484-15	12	2	115	2.50	3503-1318	1	104	174	576.20	3525-3-79	1	20	229	470.00
3485-4-13	12	2	79	10.00	3504	1	20	215	276.90	3525-3-80	1	20	229	470.00
3485-6-13	12	3	79	12.00	3510-2-39	1	25	84	262.00	3526-2-13	1	12	85	275.00
3486-12-13	1	9	187	80.00	3510-3-39	1	24	84	340.00	3526-3-13	1	19	85	400.00
3486-15-13	1	16	187	84.00	3511-2-55	1	18	84	440.00	3527-1-13	1	18	85	265.00
3487-1014-13	1	7	187	80.00	3511-3-55	1	24	84	600.00	3527-2-13	1	22	85	315.00
3487-1020-13	1	12	187	80.00	3512-1-39	1	9	84	130.00	3527-3-13	1	29	85	475.00
3487-1212-13	1	9	187	80.00	3513-1-13	1	48	83	765.00	3528-3-11	1	23	89	1050.00
3487-13BRACKET1	5	187	55.00	3513-1-98	1	48	83	765.00	3529-2-11	1	57	89	840.00	
3488	3	22	5	52.00	3513-2-13	1	76	83	1150.00	3530-PKIT	1	2	87	20.00
3489-23-99	6	3	11	24.00	3513-2-98	1	76	83	1150.00	3531-1-13	1	10	86	190.00
3489-46-99	6	9	11	32.00	3514-4-39	1	26	84	590.00	353-13	6	16	79	37.90
3489-811-99	3	16	11	48.00	3515-5-98	1	65	83	1580.00	3532-1-13	1	10	86	285.00
3490-71	1	50	180	925.00	3516-2-13	1	29	82	590.00	3533-1-13	1	10	87	190.00
3492-4-15	1	11	53	144.60	3516-2-13FF	1	24	82	590.00	3534-1-13	1	10	87	285.00
3492-4-15HL	1	11	53	176.70	3516-2-98	1	29	82	590.00	354-1-13	12	38	79	57.90
3492-4-15NL	1	11	53	176.70	3516-2-98FF	1	24	82	590.00	355	1	4	224	104.40
3493-13L	1	65	171	1385.25	3516-3-13	1	51	82	735.00	3550	6	2	11	17.80
3493-13S	1	65	171	760.00	3516-3-13FF	1	44	82	735.00	3551-55	1	9	102	38.00
3494-2-99	1	36	6	230.00	3516-3-98	1	51	82	735.00	3552-10-65M	1	16	139	132.20
3494-3-99	1	45	6	280.00	3516-3-98FF	1	44	82	735.00	3552-12-65M	1	23	139	188.80
3495	1	38	180	700.00	3516-5-13	1	65	82	1150.00	3552-6-65M	1	7	139	69.20
3496-1111-21	3	9	183	46.00	3516-5-13FF	1	55	82	1150.00	3553ICE	1	34	11	278.10
3496-1111-71	3	9	183	52.00	3516-5-98	1	56	82	1150.00	3553INF	1	34	11	278.10

visit us online at: www.calmil.com **CAL·MIL** call toll-free 800-321-9069

Index

Part #	Pack	Shipping Weight	Page	Price Ea.	Part #	Pack	Shipping Weight	Page	Price Ea.	Part #	Pack	Shipping Weight	Page	Price Ea.
3554ICE	1	31	101	333.30	398	4	9	226	46.80	418-8-63	3	7	115	33.00
3554INF	1	31	101	333.30	399-13	48	12	79	9.40	418-8-64	3	7	115	33.00
356	1	4	224	104.40	401-12-34	6	14	79	22.50	432-13-43	1	9	60	117.40
3600-65M	6	4	189	10.00	401-15-34	6	20	79	36.10	432-3-60	1	6	17	86.00
360-2	1	23	74	168.10	401-18-34	6	35	79	51.10	432-3-96	1	6	36	86.00
360-2-60	1	23	22	158.80	401-24-34	4	49	79	77.70	432-3-99	1	13	2	112.00
360-2-96	1	24	38	158.80	403-10-34	6	12	79	29.10	432-6-60	1	14	17	98.40
360-4	1	23	74	198.80	403-15-34	6	23	79	57.90	432-6-96	1	14	36	98.40
361-12	4	32	121	119.90	403-18-34	6	35	79	77.70	432-6-99	1	18	2	120.00
362-12	4	25	120	102.40	407-8-13	12	9	131	23.70	432-8-43	1	9	60	88.20
367-10	6	18	121	78.80	411-12	6	10	177	61.70	432-9-60	1	23	17	110.50
367-12	4	32	121	102.40	411-16	3	9	177	98.20	432-9-96	1	20	36	110.50
368-12-17	1	26	137	507.90	411-24	1	9	177	224.30	432-9-99	1	28	2	128.00
368-12-24	1	26	137	507.90	412-12-52	1	41	43	379.10	438	6	10	102	12.90
369	1	19	206	189.80	412-18-52	1	53	43	524.40	451-12	1	26	136	323.00
369-39	1	19	206	189.80	413-12-13	1	26	60	527.50	451-18	1	53	136	447.50
370	1	35	93	203.10	413-18-13	1	35	60	898.80	453-13	6	8	131	57.90
372	1	24	93	218.50	413-24-13	1	Inquire	60	1850.10	463-12-13	1	41	137	287.30
373	2	18	228	117.20	414-10	6	6	177	51.30	463-12-24	1	41	137	375.30
373-H	2	18	228	117.20	414-12	6	8	177	61.70	463-18-13	1	53	137	419.30
373-N	2	18	228	117.20	414-16	3	7	177	98.20	463-18-24	1	53	137	579.80
375-12	1	11	80	101.70	414-24	1	7	177	224.30	469	1	20	196	309.20
375-13	1	11	80	101.70	414-32	1	14	177	428.40	473-12-24	1	26	137	357.60
376-12	1	15	80	128.40	418-10-13	3	12	115	55.70	473-18-24	1	41	137	695.10
376-13	1	15	80	128.40	418-10-15	3	12	115	55.70	475-10-13	1	12	81	132.20
377-12	1	17	80	143.70	418-10-61	3	12	115	55.70	475-10-15	1	12	81	132.20
378	1	22	206	100.30	418-10-62	3	12	115	55.70	475-10-51	1	12	135	124.80
378-60	1	22	20	110.50	418-10-63	3	12	115	55.70	475-10-55	1	12	135	124.80
378-96	1	22	39	113.90	418-10-64	3	12	115	55.70	475-10-60	1	12	27	121.80
378-99	1	22	8	160.00	418-6-13	12	11	115	22.20	475-10-96	1	12	37	121.80
386	1	28	227	463.70	418-6-15	12	11	115	22.20	475-12-13	1	18	81	188.80
387-13	1	15	80	139.40	418-6-61	12	11	115	22.20	475-12-15	1	18	81	188.80
388	1	13	216	131.20	418-6-62	12	11	115	22.20	475-12-51	1	18	135	166.60
390	1	9	216	108.20	418-6-63	12	11	115	22.20	475-12-55	1	18	135	166.60
391-010	12	5	103	22.50	418-6-64	12	11	115	22.20	475-12-60	1	18	27	156.90
392-010	12	3	103	18.30	418-8-13	3	7	115	33.00	475-12-96	1	26	37	156.90
393	1	12	226	232.30	418-8-15	3	7	115	33.00	475-6-13	1	5	81	69.20
394	1	19	227	108.60	418-8-61	3	7	115	33.00	475-6-15	1	5	81	69.20
396	4	9	226	46.80	418-8-62	3	7	115	33.00	475-6-51	1	4	135	55.50

Part #	Pack	Shipping Weight	Page	Price Ea.	Part #	Pack	Shipping Weight	Page	Price Ea.	Part #	Pack	Shipping Weight	Page	Price Ea.
475-6-55	1	4	135	55.50	576	24	43	214	9.90	682-ICE	1	7	102	31.90
475-6-60	1	5	27	69.20	580	24	14	214	7.00	682-INFUSION	1	7	102	31.90
475-6-96	1	5	37	69.20	583	12	13	214	16.30	694	6	20	237	49.00
476-10	1	26	138	81.30	586	24	14	213	7.20	695-17	6	12	213	40.10
476-10-13	1	32	138	81.30	587-49	1	4	204	125.70	707-12	1	10	137	110.80
476-6	1	9	138	64.70	591	48	5	214	2.50	709-3	1	24	78	176.10
477-12CL	4	32	138	79.90	606-1	12	3	21	11.30	710-4	1	34	132	458.80
477-18	2	41	138	130.50	606-2	12	3	21	11.30	710-6	1	49	132	521.10
482-12-13	1	11	119	60.50	606-3	12	3	21	11.30	716-12	6	8	177	66.80
482-15-13	1	13	119	64.60	606-4	12	3	21	11.30	718	1	83	91	1156.50
490-12	8	24	222	33.60	618-1	12	2	217	18.30	723	1	35	90	588.50
492	2	13	228	90.70	618-2	12	2	217	18.30	723-53	1	35	90	588.50
492-H	2	13	228	90.70	618-3	12	2	217	18.30	724	1	11	78	106.60
492-N	2	13	228	90.70	623	1	3	225	49.40	728-13	1	26	131	397.20
495	1	30	197	287.30	624	1	5	225	70.30	741	1	10	150	284.00
496	1	30	197	357.60	631	1	7	225	88.40	751-3	1	32	131	466.20
498	1	53	236	529.80	632-1	12	2	103	22.50	751-4	1	35	131	553.80
500	24	6	214	4.70	632-2	12	2	103	22.50	751-6	1	49	131	655.50
506	24	9	214	5.30	632-3	12	2	103	22.50	761-13	2	41	81	132.80
507	12	30	213	19.20	633	12	29	213	17.90	766	1	41	93	437.00
509	24	3	214	4.70	635-12	2	7	80	40.10	768	1	25	132	330.90
512	24	9	214	4.70	635-13	2	7	80	40.10	772-S	1	Inquire	133	573.60
513	12	13	214	11.50	638	1	7	225	88.40	774-S	1	Inquire	133	661.90
515	24	10	214	6.00	639	1	43	93	191.00	776-S	1	34	133	353.30
521	24	9	214	4.70	642	1	41	93	463.70	778-S	1	48	133	419.30
523	24	9	214	5.30	650-17	12	7	213	24.80	786	1	15	199	151.90
524	24	14	214	7.00	653-17	12	11	213	29.10	787-12	4	7	80	35.60
526	12	13	214	13.80	654	12	10	213	8.60	787-13	4	7	80	35.60
530	12	30	213	21.40	656	1	26	93	198.90	789	1	2	224	85.60
532	24	9	214	4.70	658	1	30	81	159.80	790	2	4	224	85.60
534-13	6	7	214	28.10	661-12-13	12	8	216	10.40	791-52	1	51	42	234.10
536-13	12	23	214	44.50	661-2-13	12	2	216	5.00	791-99	1	38	152	468.20
537	24	9	214	5.50	661-9-13	12	4	216	7.70	792	1	13	224	133.40
538	24	12	214	6.30	671-1	1	2	216	18.30	793	1	8	224	133.40
541	24	25	214	12.50	671-2	1	2	216	18.30	796-60	1	5	23	58.20
542	24	30	214	14.90	677	1	12	78	150.30	796-96	1	5	38	58.20
561	24	7	214	4.30	681-4-13	12	2	103	9.90	796-99	1	5	9	58.20
570	24	12	214	6.30	681-6-13	12	4	103	11.20	808-13	1	5	205	51.60
575	24	35	214	8.50	682	1	7	102	31.90	809-12	24	20	222	14.00

visit us online at: www.calmil.com **CAL·MIL** call toll-free 800-321-9069

Index

Part #	Pack	Shipping Weight	Page	Price Ea.	Part #	Pack	Shipping Weight	Page	Price Ea.	Part #	Pack	Shipping Weight	Page	Price Ea.
810-52	1	36	43	587.60	927-N	2	12	228	88.70	972-5-17INF	1	53	97	953.00
810-53	1	36	43	587.60	930-1-13	12	34	79	53.30	977-10-13	1	20	72	72.00
813-52	1	56	40	604.10	930-2-13	12	21	79	35.60	977-10-49	1	20	72	72.00
813-96	1	56	34	604.10	930-3-13	12	43	79	61.70	977-8-13	2	11	72	68.10
814-1-52	1	56	41	594.50	932-2	1	30	60	591.10	977-8-49	1	11	72	68.10
814-52	1	56	41	594.50	932-2INF	1	30	60	591.10	978-12	2	7	126	77.70
815-52	1	66	41	910.60	932-3	1	30	60	764.20	985-12	1	36	143	419.30
815-52A	1	66	41	910.60	932-3INF	1	30	60	764.20	986-12	1	32	143	661.90
823	1	7	24	37.00	941	1	43	175	507.90	987-12	1	Inquire	143	772.30
828	6	30	212	62.80	942-S	1	44	175	529.80	989-12	1	32	143	485.40
829	12	12	212	35.00	943	1	34	164	330.90	992	1	26	164	265.00
830	24	7	212	19.30	944	1	26	164	276.10	993-17	6	9	219	42.20
831-RD	2	10	42	58.60	945	1	30	164	375.30	999	1	19	164	209.80
831-SQ	2	10	42	52.70	946	1	42	227	485.40	BH4220-13	1	4	138	264.40
841	1	13	198	97.50	947	1	18	227	185.60	BH4618-13	1	4	138	310.80
851-WET	1	18	43	276.90	948	1	28	164	221.00	C1222-10	1	24	72	78.30
852-52	1	15	43	221.10	950-13	6	4	219	10.70	C1222-8	1	20	72	71.20
852-55	1	17	215	288.40	952	1	9	205	57.90	C1223-10	1	24	72	90.00
852-60	1	15	29	221.10	956-10	12	4	218	18.20	C1223-8	1	20	72	83.00
866	1	91	196	697.90	956-11	12	4	218	18.20	C1235INSERT	3	5	59	33.10
869	1	3	216	117.40	958-1-13	12	38	79	53.30	C1280B	1	24	165	236.30
869-1	1	2	216	117.40	958-1-19	12	38	79	97.50	C1281B	1	36	165	314.90
869-2	1	2	216	117.40	958-1-60	6	41	23	66.20	C1432BODY	3	5	190	14.80
872-12	1	5	159	43.30	958-2-13	12	23	79	35.60	C1432BODYC	3	5	115	18.30
872-16	1	6	159	53.90	958-2-19	12	23	79	71.00	C1432LID	6	2	190	11.30
872-24	1	8	159	64.70	960	1	26	175	397.20	C1432NL	6	2	190	11.30
879-12	1	5	159	34.00	963-S	1	26	175	419.30	C3334JAR	6	6	232	7.80
879-16	1	6	159	43.30	971-5-17	1	53	97	953.00	C3335JAR	3	9	232	13.90
879-24	1	8	159	53.90	972-1-17	1	29	97	545.80	C3336JAR	3	7	232	16.50
891	24	6	219	19.30	972-1-17INF	1	29	97	545.80	C4X4-60	3	4	190	18.90
902-12	1	Inquire	143	1279.70	972-2-17	1	22	97	591.10	C4X4-96	3	4	190	18.90
903-12	1	Inquire	143	1652.30	972-2-17INF	1	22	97	591.10	C4X4GLCN	3	6	190	19.50
904-12	1	Inquire	143	1963.10	972-2-52	1	Inquire	42	591.10	C732-60	3	10	18	86.90
910	4	13	204	44.60	972-2-53	1	Inquire	42	591.10	C732-96	3	10	32	86.90
920	1	32	173	278.60	972-3-17	1	30	97	764.20	C732GLASS	1	10	42	79.90
921	1	49	173	428.20	972-3-17INF	1	30	97	764.20	CC306	1	4	159	108.50
925	1	9	199	154.80	972-3-52	1	25	42	764.20	CC308	1	8	159	138.90
927	2	12	228	88.70	972-3-53	1	25	42	764.20	CC310	1	14	159	152.40
927-H	2	12	228	88.70	972-5-17	1	53	97	953.00	CC312	1	21	159	179.60

Part #	Pack	Shipping Weight	Page	Price Ea.	Part #	Pack	Shipping Weight	Page	Price Ea.	Part #	Pack	Shipping Weight	Page	Price Ea.
CC3328	1	6	53	87.80	IP402-13	1	Inquire	140	2398.40	P295	1	9	78	154.80
CC3329	1	6	53	87.80	IP402-39	1	Inquire	140	2398.40	P296	1	20	78	199.70
CC334	1	25	159	418.10	IP501-110	1	100	142	3865.20	P297	1	32	78	244.10
CH107	1	8	156	128.50	IP501-220	1	100	142	3865.20	P302	6	25	117	30.20
CR400	1	42	92	556.20	IPAD	3	3	140	125.80	P306	6	7	117	28.00
CR402	1	78	92	721.00	JC100	1	9	102	44.10	P308	1	11	117	60.50
DE1030-31	1	32	178	449.60	JC102	3	15	102	54.20	P311	3	26	117	44.60
DM005	2	16	103	66.20	JC201	1	31	100	394.90	P313	6	18	117	31.40
DM252	6	11	110	62.10	JC301-13	1	29	100	394.90	P406	48	16	214	5.00
GE242-43	3	12	61	131.60	JC302-13	1	22	100	329.10	PC200-13	1	56	73	861.00
GE243-43	3	14	61	131.60	JC303-13	1	51	100	438.80	PC200-39	1	56	73	861.00
GL11-43	3	10	61	131.60	JC303-39	1	51	100	438.80	PC300-13	1	108	73	1023.70
GL1600-13	1	78	59	351.00	LED100	1	10	140	755.90	PC300-39	1	108	73	1023.70
GL1600-39	1	78	59	351.00	LED200	1	16	140	1006.70	PP103-13	1	30	108	462.40
GL2400-13	1	42	58	702.00	LQ31	1	Inquire	236	1097.00	PP1033-13	1	30	108	493.40
GL2400-39	1	42	58	702.00	MC700	1	14	159	745.70	PP1033-39	1	36	108	493.40
GL2450-43	1	14	61	241.30	MC706	1	7	159	142.30	PP103-39	1	30	108	462.40
GL250-43	3	7	61	41.70	MC708	1	25	159	202.30	PP1151	3	10	109	27.50
GL252-43	6	7	61	54.90	MC710	1	14	159	264.40	PP1153	12	11	109	18.70
GL352-43	4	12	61	153.60	MC712	1	25	159	341.20	PP1167	1	9	109	38.50
GL353-43	4	22	61	153.60	MR1300-13	1	12	155	302.30	PP150	3	8	109	51.80
GT12	6	14	177	44.10	MT100	1	54	178	841.70	PP151	4	16	109	76.10
GT1288	1	62	177	959.20	MT220	1	36	178	841.70	PP152	3	26	109	94.90
H350-13	1	4	59	119.10	MT240	1	17	178	841.70	PP1600-13	1	78	106	462.40
HU891	4	32	72	123.30	MT300	1	56	178	1020.30	PP2000-13	1	26	107	346.40
IP101-110	1	54	142	2276.60	P232-12	4	10	120	44.90	PP2000-39	1	26	107	346.40
IP101-220	1	54	142	2276.60	P235-12	4	13	120	55.10	PP203-13	1	42	108	361.80
IP1020-13	1	54	140	1120.80	P241	1	70	172	572.40	PP203-39	1	42	108	361.80
IP1020-39	1	54	140	1120.80	P241SS	1	70	172	572.40	PP2100-13	1	42	107	482.00
IP102-13	1	54	141	899.40	P254	1	Inquire	171	1249.50	PP2100-39	1	42	107	482.00
IP102-39	1	54	141	899.40	P254SS	1	Inquire	171	1249.50	PP2150	3	43	109	107.10
IP152	1	49	141	623.80	P255	1	56	174	449.50	PP2200-13	1	30	108	493.40
IP201-110	1	212	142	4376.00	P255-13	1	67	168	551.90	PP2200-39	1	30	108	493.40
IP201-220	1	212	142	4376.00	P255-48	1	56	168	551.90	PP2301-13	1	56	106	462.40
IP2020-13	1	102	140	1866.60	P255-52	1	64	40	727.30	PP2301-39	1	56	106	462.40
IP2020-39	1	102	140	1866.60	P255-52S	1	67	40	857.80	PP250	3	7	109	23.20
IP202-13	1	117	141	1563.80	P255-96	1	64	34	727.30	PP251	3	7	109	27.50
IP202-39	1	117	141	1563.80	P255-96S	1	64	34	857.80	PP252	3	20	109	40.80
IP252	1	79	141	1087.00	P257	1	30	173	235.10	PP302-13	1	25	106	303.30

visit us online at: www.calmil.com **CAL-MIL** call toll-free 800-321-9069

Index

Part #	Pack	Shipping Weight	Page	Price Ea.	Part #	Pack	Shipping Weight	Page	Price Ea.	Part #	Pack	Shipping Weight	Page	Price Ea.
PP302-39	1	25	106	303.30	SR1520-13	1	41	111	321.40	SS230-31	1	19	179	460.90
PP351	3	21	109	56.20	SR1600-13	1	78	110	299.90	SS290-31	1	25	179	674.50
PP551	3	21	109	107.10	SR1600-39	1	78	110	299.90	SS3039-30	1	23	179	506.10
PP650	4	12	109	50.80	SR2020-13	1	29	111	235.70	SS3039-31	1	23	179	506.10
PP703-13	1	51	107	570.40	SR2030-13	1	36	113	299.90	SS312-30	1	25	179	506.10
PP703-39	1	51	107	570.40	SR2301-13	1	70	110	299.90	SS312-31	1	25	179	506.10
PP750	3	35	109	51.40	SR2301-39	1	70	110	299.90	SS353-30	1	25	179	590.90
PT151	1	6	177	118.60	SR252	3	7	114	37.50	SS353-31	1	25	179	590.90
PT155	1	7	176	257.60	SR252-65M	3	15	186	32.00	SS800-31	1	91	178	831.60
PT185	1	13	176	333.20	SR261	3	6	114	32.10	UG101-43	4	22	61	153.60
PT241	1	7	177	300.60	SR262	3	9	114	42.90	WU100	1	16	140	285.80
PT242	1	12	177	259.90	SR263	3	12	114	53.60	WU200	1	34	140	405.60
PT243	1	6	177	259.90	SR302-13	1	47	112	342.80					
PT245	1	13	176	420.30	SR302-39	1	54	112	342.80					
PT253	1	5	177	56.40	SR303-13	1	48	112	321.40					
PT321	1	43	177	488.10	SR303-39	1	48	112	321.40					
PT322	1	11	177	361.50	SR304-13	1	29	112	235.70					
PT323	1	25	177	361.50	SR304-39	1	29	112	235.70					
PT325	1	19	176	544.70	SR307-13	1	29	113	257.10					
PT402	1	19	177	459.80	SR350	6	5	114	40.70					
PT403	1	19	177	459.80	SR351	3	7	114	46.00					
PT450	1	7	177	161.60	SR402-13	1	47	113	299.90					
RR150	1	7	176	142.30	SR402-39	1	47	113	299.90					
RR161	1	7	176	191.00	SR549	3	6	114	48.20					
RR240	1	19	176	384.20	SR630-13	1	18	155	248.20					
RR241	1	19	176	384.20	SR701-13	1	36	111	299.90					
RR242	1	11	176	347.90	SR701-39	1	42	111	299.90					
RR243	1	13	176	359.30	SR750	3	12	114	53.60					
RR320	1	32	176	580.70	SR801-13	1	49	112	364.20					
RR322	1	19	176	483.60	SR801-39	1	49	112	364.20					
RR323	1	21	176	518.60	SR850	3	12	114	48.20					
RR402	1	41	176	623.80	SR851	3	14	114	58.90					
RR403	1	43	176	623.70	SR852	3	21	114	64.30					
SR1010-13	1	36	113	235.70	SR900-13	1	54	111	321.40					
SR1020-13	1	35	113	299.90	SR900-39	1	54	111	321.40					
SR1033-13	1	30	111	321.40	SR950	3	13	114	42.80					
SR1033-39	1	30	111	321.40	SS150-31	1	7	179	180.80					
SR150	3	13	114	58.90	SS2289-30	1	19	179	421.50					
SR152	3	21	114	67.30	SS2289-31	1	19	179	421.50					

CORPORATE OFFICES
CAL•MIL
4079 Calle Platino
Oceanside, CA 92056-5805



Phone: (760) 630-5100
Toll Free: (800) 321-9069
General Fax: (760) 630-9865
For Ordering Fax: (760) 630-5010
US, Alaska, Hawaii & Canada

TERMS OF SALE

All Enclosed Prices and Terms
EFFECTIVE January 1, 2016

1. FREIGHT TERMS

All weights and measurements shown herein are approximate.
All orders are FOB Oceanside, CA.

A. FREIGHT PREPAID - CONTINENTAL USA

Freight will be prepaid on orders \$5,700 NET or more, based on a single order for a single delivery within the continental U.S. All Cal•Mil catalog products may be combined to obtain prepaid freight, excluding Custom Orders or Net Quoted pricing of catalog items.

B. FREIGHT - INTERNATIONAL

All international freight is the sole responsibility of the Broker, Dealer or any purchasing entity.

C. FREIGHT COLLECT or PREPAID AND CHARGED BACK:

All orders, not meeting Cal•Mil Prepaid Freight Policy and all Custom Manufactured Products are FOB Oceanside, CA, Freight Collect or Prepaid and Charged Back.

D. 3rd PARTY OR COLLECT FREIGHT

All 3rd party or collect shipments are solely the responsibility of the Customer. All 3rd party or collect damage claims, lost items, freight disputes or any other type of charges are the sole responsibility of the Customer. Any payments sent to CAL-MIL for claims will be forwarded to the customer in the form of a credit memo.

2. PRICES

All published prices are LIST in U.S. Dollars and are subject to change without notice. All orders will be received with the understanding that prices will be those in effect at the time of shipment. These prices are exclusive of all export fees, transportation charges, sales taxes or any special taxes which may be levied by Federal, State or City Governments.

3. RETURNS

The request to return goods must be made within 60 days of the Invoice Date. No merchandise may be returned without a written authorization number from the factory. Contact Cal•Mil Customer Service at 1-800-321-9069 to request authorization. Merchandise must be shipped Freight Prepaid by sender. All return goods must be in unused condition and packaged in their original shipping cartons and packing material. Credit issued will be based only on product returned in restockable

condition. The determination of the condition of the goods will be made solely by Cal•Mil. Custom, Discontinued or Non-standard merchandise may not be returned. **ALL RETURNS ARE SUBJECT TO A 20% RESTOCKING CHARGE.**

4. TERMS

Net 30 Days O.A.C. All orders are subject to acceptance by Cal•Mil, in accordance with our "Terms of Sale", regardless of any form in which a purchase order is submitted. All Credit Card payments subject to 3% fee.

5. MINIMUM ORDER

Minimum Order for established accounts will be \$220.00 LIST. A \$10.00 Handling Charge will be applied to all orders under \$220.00 LIST. Orders calling for Less Than Standard Pack will be charged \$5.00 NET per Broken Case.

6. CUSTOM PRODUCTS

All CUSTOM Products are FOB OCEANSIDE, CA. Finished Custom Quantities may vary by + or - 5%.

7. TITLES & DAMAGES

Merchandise will be delivered FOB Factory and title passes to buyer upon delivery of merchandise to a common carrier for shipment to buyer. Should damage occur, it is the Consignee's responsibility to notify the delivering carrier within 48 hours. Retain all cartons, packing material and merchandise for carrier inspection. Call Cal•Mil Customer Service at 1-800-321-9069 within 48 hours to notify of damage. We are willing to assist in filing claims, but the filing is Consignee's responsibility.

8. SHORTAGES/ERRORS

A. SHORTAGE OF MERCHANDISE

Contact Cal•Mil Customer Service at 1-800-321-9069 to report any shortage of merchandise within 48 hours of receipt.

B. ERRORS

Cal•Mil is not responsible for typographical errors made in the act of quoting, acknowledgements, publications or invoices. All such errors are subject to correction.

9. GENERAL

This Agreement shall be governed by the laws of the state of California.

WARNING NOTICE: Some of the products described in the Cal•Mil 2016 Catalog may contain a chemical known to the State of California to cause cancer, birth defects or other reproductive harm. Please contact us for further information.

CORPORATE OFFICES
CAL•MIL
4079 Calle Platino
Oceanside, CA 92056-5805



Phone: (760) 630-5100
Toll Free: (800) 321-9069
General Fax: (760) 630-9865
For Ordering Fax: (760) 630-5010
US, Alaska, Hawaii & Canada

TERMS OF SALE

All Enclosed Prices and Terms
EFFECTIVE January 1, 2016

1. FREIGHT TERMS

All weights and measurements shown herein are approximate.
All orders are FOB Oceanside, CA.

A. FREIGHT PREPAID - CONTINENTAL USA

Freight will be prepaid on orders \$5,700 NET or more, based on a single order for a single delivery within the continental U.S. All Cal•Mil catalog products may be combined to obtain prepaid freight, excluding Custom Orders or Net Quoted pricing of catalog items.

B. FREIGHT - INTERNATIONAL

All international freight is the sole responsibility of the Broker, Dealer or any purchasing entity.

C. FREIGHT COLLECT or PREPAID AND CHARGED BACK:

All orders, not meeting Cal•Mil Prepaid Freight Policy and all Custom Manufactured Products are FOB Oceanside, CA, Freight Collect or Prepaid and Charged Back.

D. 3rd PARTY OR COLLECT FREIGHT

All 3rd party or collect shipments are solely the responsibility of the Customer. All 3rd party or collect damage claims, lost items, freight disputes or any other type of charges are the sole responsibility of the Customer. Any payments sent to CAL-MIL for claims will be forwarded to the customer in the form of a credit memo.

2. PRICES

All published prices are LIST in U.S. Dollars and are subject to change without notice. All orders will be received with the understanding that prices will be those in effect at the time of shipment. These prices are exclusive of all export fees, transportation charges, sales taxes or any special taxes which may be levied by Federal, State or City Governments.

3. RETURNS

The request to return goods must be made within 60 days of the Invoice Date. No merchandise may be returned without a written authorization number from the factory. Contact Cal•Mil Customer Service at 1-800-321-9069 to request authorization. Merchandise must be shipped Freight Prepaid by sender. All return goods must be in unused condition and packaged in their original shipping cartons and packing material. Credit issued will be based only on product returned in restockable condition. The determination of the condition of the goods will be made solely by Cal•Mil. Custom, Discontinued or Non-

standard merchandise may not be returned. **ALL RETURNS ARE SUBJECT TO A 20% RESTOCKING CHARGE.**

4. TERMS

Net 30 Days O.A.C. All orders are subject to acceptance by Cal•Mil, in accordance with our "Terms of Sale", regardless of any form in which a purchase order is submitted. All Credit Card payments subject to 3% fee.

5. MINIMUM ORDER

Minimum Order for established accounts will be \$220.00 LIST. A \$10.00 Handling Charge will be applied to all orders under \$220.00 LIST. Orders calling for Less Than Standard Pack will be charged \$5.00 NET per Broken Case.

6. CUSTOM PRODUCTS

All CUSTOM Products are FOB OCEANSIDE, CA. Finished Custom Quantities may vary by + or - 5%.

7. TITLES & DAMAGES

Merchandise will be delivered FOB Factory and title passes to buyer upon delivery of merchandise to a common carrier for shipment to buyer. Should damage occur, it is the Consignee's responsibility to notify the delivering carrier within 48 hours. Retain all cartons, packing material and merchandise for carrier inspection. Call Cal•Mil Customer Service at 1-800-321-9069 within 48 hours to notify of damage. We are willing to assist in filing claims, but the filing is Consignee's responsibility.

8. SHORTAGES/ERRORS

A. SHORTAGE OF MERCHANDISE

Contact Cal•Mil Customer Service at 1-800-321-9069 to report any shortage of merchandise within 48 hours of receipt.

B. ERRORS

Cal•Mil is not responsible for typographical errors made in the act of quoting, acknowledgements, publications or invoices. All such errors are subject to correction.

9. GENERAL

This Agreement shall be governed by the laws of the state of California.

WARNING NOTICE: Some of the products described in the Cal•Mil 2016 Catalog may contain a chemical known to the State of California to cause cancer, birth defects or other reproductive harm. Please contact us for further information.